

P.R. 000
R0000 - R0000

01.20
P.R.1233

01.20
P.R.1233

P.R. 000
R0000 - R0000

1	2	3	4	5	6	1995
7	8	9	10	11	12	

RENAULT 21 1992 ▽ 1994

L48S
L488
L48Y
L48Z
L48G
L48X
L48K

K48S
K488
K48Y
K487
K48G
K48X

P.R. 1233

②

02 25 127 100



Peças Reposição
Piezas de repuesto
Pieces de rechange
Spare parts

RENAULT

MOD. 92.10 ▷ MOD. 94.10

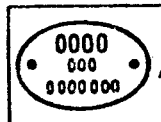
01.22

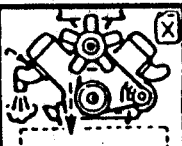
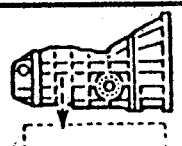

MODELO SERIE						SISTEMA ANTIPOLUCION TROPICALIZADO		
L48S		NG9 001 NG9 009	TXE					
L488		NG9 001 NG9 009		GTX				
K488		NG9 001 NG9 009		GTX BREAK				
K48S		NG9 001 NG9 009	TXE BREAK					
L48Z 095/096	Injection	NG9 007 NG9 010						
L48Y 090/091	Injection	NG9 012	TXE					
K48Y 090/092	Injection	NG9 012	TXE BREAK					
K487 089		NG9 009			GLX			
K48G 202	Injection	NG9 010		GTX BREAK		X		
L48G 202	Injection	NG9 010		GTX		X		
L48K 205/209/209	Injection	NG9 010		TXI		X		
K48X 210	Injection	NG9 010	TXE BREAK			X		
L48X 208/204	Injection	NG9 010	TXE			X		

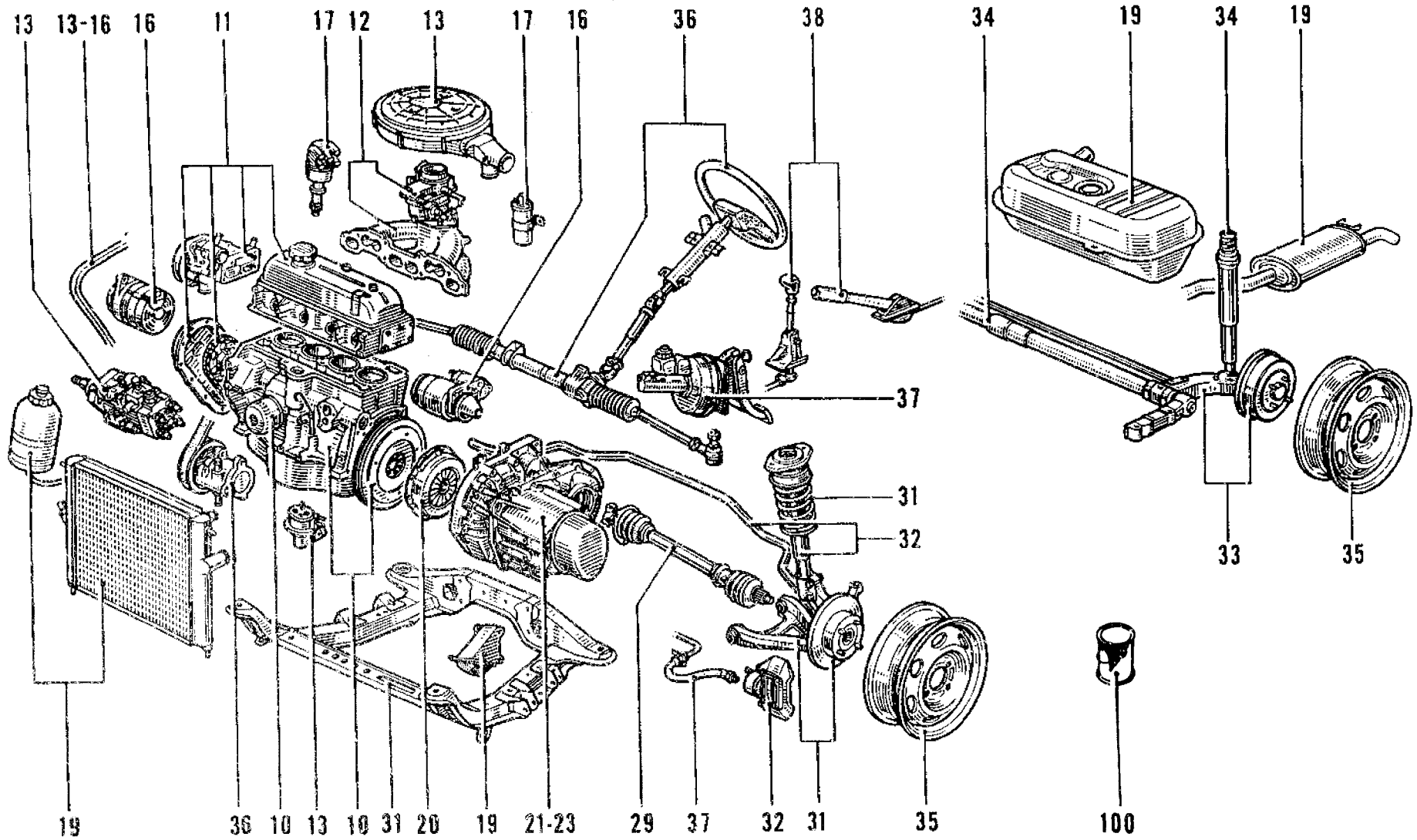

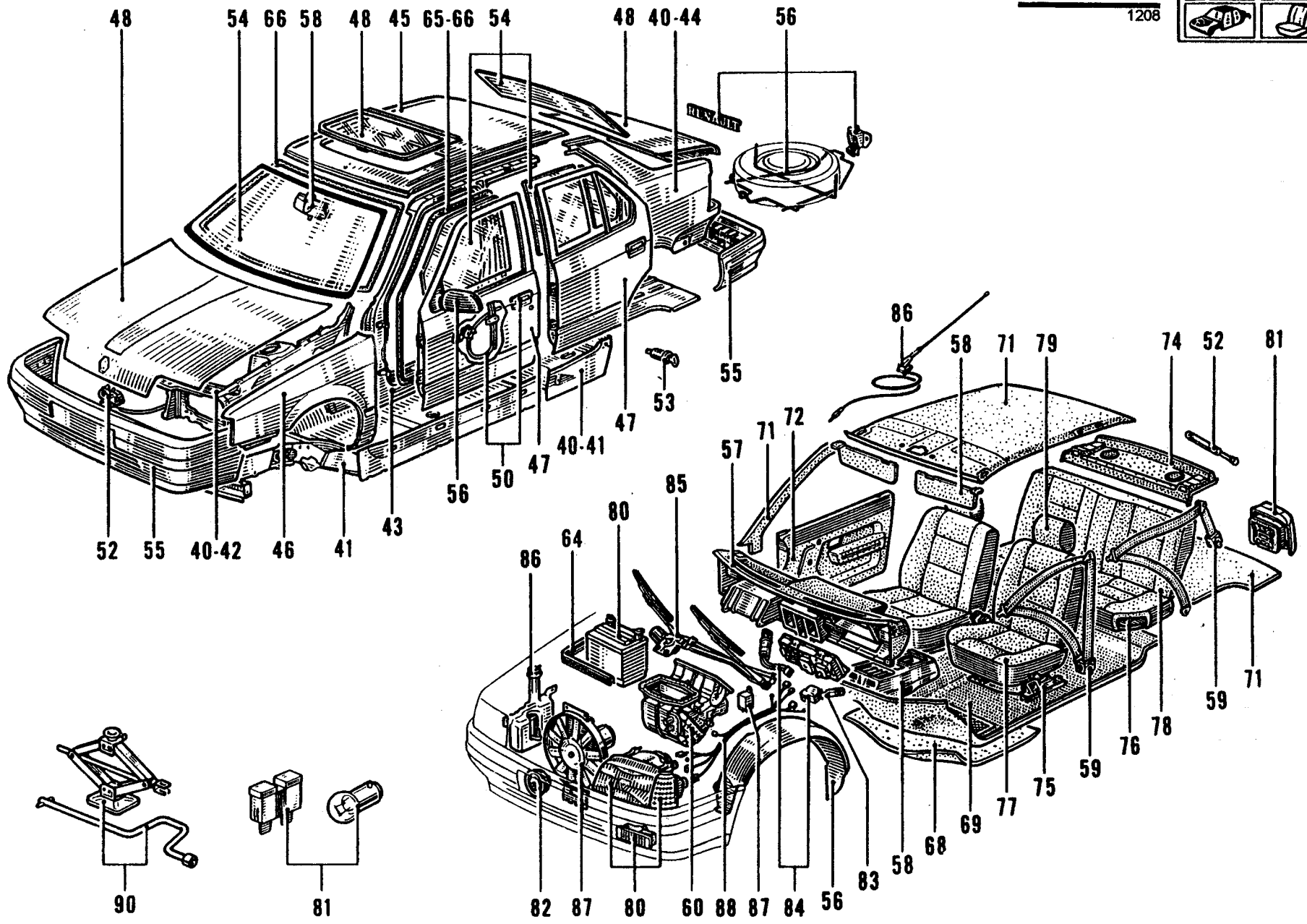
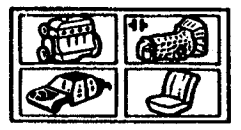

02.03

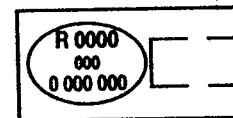

PORTUGUES

PARA ENCOMENDAR A PEÇAS SOBRESALENTES
QUEIRA INDICAR:

- ① O tipo de veículo.
- ② O N° de equipamento.
- ③ O N° de fabricação do veículo.
- ④ O tipo e o N° de fabricação do órgão.
- ⑤ O N° de peça.
- ⑥ Facultativo o N° de catálogo, o N° da prancha.
- ⑦ O N° de código de estofado.
- ⑧ O N° de código da tinta.
- ⑨ O N° de identificação do veículo.

Sé os outros N° do veículo estão destruídos, indicar o N° da serie do tipo (ver carta de garantia).

INTRODUCCION

Este catálogo contiene todos los conjuntos y piezas sueltas y vendidas como repuestos. en él los números se encuentran con precisión y por medio de las láminas se los puede identificar con toda facilidad.

Estos conjuntos y piezas están distribuidos en láminas según el sistema o elemento del mismo al cual pertenecen.

Todas las láminas llevan un número de cuatro cifras, de las cuales, las dos primeras corresponden a la numeración codificada del sistema; cuando la lámina pueda confundirse con otras similares lleva especificada la variante en cuestión o el número de serie del vehículo a partir del cual se incorporan las piezas mencionadas en la misma.

Una lámina se compone de:

La ilustración de las piezas o conjuntos del sistema detallado; a cada pieza ilustrada pueden corresponder uno o varios números de piezas que se diferencian entre ellos por una variante o bien por un símbolo codificado y, eventualmente, de cuadros de referencias en los que se mencionan informaciones complementarias tales como el número de serie del vehículo a partir del cual se incorporan los cambios o algún dato dimensional. Estos cuadros figuran, ya sea debajo de la ilustración, o bien, en una página anexa a la ilustración.

Observación: el significado de los símbolos y expresiones codificadas utilizadas en cada lámina están indicadas en la lámina N° 05.01...

Un índice ilustrado de las láminas ubicado al comienzo del presente catálogo, indica debajo de cada figura representada, el número de la lámina que hay que consultar. Un índice numérico ubicado al final del catálogo, indica la correspondencia entre los números de piezas y los números de las láminas que se muestran.

MODO DE EMPLEO

Determinación del número de una pieza, cuando se la reconoce físicamente:

1. Buscar en el índice ilustrado la lámina correspondiente al sistema o elemento del sistema al que la pieza pueda pertenecer.
2. Consultar el Catálogo y buscar la lámina, teniendo en cuenta las variantes precisas que pudieran existir o el número de serie del vehículo, según corresponda.
3. Una vez encontrada la lámina, buscar el dibujo de la pieza deseada. A dicho dibujo puede corresponder uno o varios números de piezas, seleccionar entre ellos el que corresponda, teniendo en cuenta los símbolos o expresiones codificadas indicadas en cada caso.

Las cifras numéricas o alfabéticas que acompañan el número de pieza sirven para vincularlo a los cuadros de referencias complementarios que se encuentran en la cara inferior de la lámina o en hoja anexa.

Verificación de números de piezas indicadas en un pedido de repuestos redactado por un cliente, confeccionado en base a documentación que éste posee.

1. Buscar en el índice numérico, el número de pieza indicado en el pedido y determinar los números de las láminas correspondientes.
2. Consultar las láminas para comprobar si el número de pieza es el que corresponde, teniendo en cuenta el número de serie del vehículo, o las variantes que pudieran existir en el sistema.

Identificación por ilustraciones de una pieza cuyo número se conoce:

1. Buscar en el índice numérico el número de pieza dado y determinar el número de la lámina en la cual está mostrada dicha pieza.
2. Consultar estas láminas.

CONDICIONES GENERALES DE VENTA

Consultar la Lista de Precios de Repuestos y Accesorios vigente a la fecha.

INTRODUCTION

Le présent document contient tous les ensembles et pièces détachées vendables en rechange; il permet de déterminer avec précision leurs numéros et de les identifier facilement par les illustrations.

Ces ensembles et ces pièces sont répartis par planches suivant l'organe ou l'élément d'organe auquel ils se rattachent.

Chaque planche est identifiée par un numéro à 4 chiffres dont les deux premiers correspondent à un code organe déterminé, elle peut être caractérisée par une variante ou un point de départ dans le cas où elle s'identifie avec une planche similaire.

Une planche se compose:

De l'illustration des pièces et ensembles de l'organe détaillé qui diffèrent de forme; à chaque pièce illustrée correspond un ou plusieurs numéros de pièces caractérisés entre eux par une variante ou un signe codifié et, éventuellement, de tableaux comportant des renseignements complémentaires tels que points de départ et consignés. Ces tableaux figurent soit en bas de l'illustration, soit sur une page annexe à l'illustration.

Remarque: la signification des signes et expressions codifiés utilisés dans chaque planche, est indiquée dans la planche N° 05.01...

Un répertoire numérique en fin de catalogue donne la correspondance entre les numéros de pièces et les numéros de planches ainsi que les quantités de pièces par véhicule dans la planche considérée.

Le document P.R. 830 Renault donne les caractéristiques des numéros de la boulonnerie normalisée.

UTILISATION

Détermination du numéro d'une pièce, connaissant la nature de celle-ci:

1. Rechercher dans le répertoire des planches la planche correspondant à l'organe ou l'élément d'organe auquel cette pièce se rattache.
2. Consulter le catalogue pour y retrouver cette planche en tenant compte éventuellement, du point de départ ou de la variante caractérisant la planche.
3. La planche étant déterminée, rechercher l'illustration de la pièce désirée. A cette illustration correspond un ou plusieurs numéros. Choisir celui qui convient, compte tenu des signes ou expressions codifiés les caractérisant.

Les renvois numériques ou alphabétiques affectés aux numéros de pièces assurent la liaison entre ces numéros et les renseignements complémentaires contenus dans les tableaux situés soit en bas de l'illustration soit en page annexe.

Vérification par les Succursales, Concessionnaires ou Centres Importateurs d'un bon de commande, rédigé par un Agent ou un client ayant utilisé la documentation en sa possession.

1. Rechercher dans le répertoire numérique au numéro de pièce donné par le bon de commande, les numéros de planches correspondantes.
2. Consulter ces planches pour vérifier si le numéro de pièce est bien celui qui convient compte tenu des points de départ affectés à ce numéro de véhicule ou d'organe pour lequel la pièce est commandée.

Identification par illustrations d'une pièce dont on connaît le numéro.

1. Rechercher dans le répertoire numérique, au numéro de pièce donné, le numéro des planches correspondantes.
2. Consulter ces planches.

CONDITIONS GÉNÉRALES DE VENTE

Voir les tarifs de pièces de rechange.

INTRODUCTION

This document contains all the assemblies and parts sold as spares. It enables one to determine with precision their numbers and to identify them easily by the illustrations. These assemblies and these parts are set out in illustrated plates according to the unit or subassembly to which they belong.

Each plate is identified by a four figure number, the first two of which correspond to a specified unit code; it may be distinguished by a variant or a starting point in the case where it is identifiable with a similar plate.

A plate consists of:

The illustration of parts and assemblies of the unit shown which differ in shape; one or several numbers correspond to each part illustrated and these are distinguished one from the other by a variant or symbol and if necessary tables showing additional information such as starting points and instructions. These tables are found on the bottom of the illustration or on a page added to the illustration.

Note: the meanings of the symbols and coded expressions used on each plate are listed on Plate N° 05.01....

A list of illustrated plates gives the Plate Number to refer to under each square.

A numerical index at the end of the catalogue gives the relationship between the part numbers and the plate numbers also the parts quantity required per vehicle in the plate concerned.

(The Renault P.R. 830 catalogue gives the specifications for all the standard bolt part numbers.

USE

Ascertaining a part Number knowing the nature of this part:

1. In the plate index, find the plate corresponding to the unit or sub-assembly to which this part may be attached.
2. Consult the catalogue to find this plate, when necessary taking into account the starting point or the variant distinguishing this plate.
3. Having found the plate, look for the illustration of the desired part. One or several numbers correspond to this illustration, choose the suitable number, taking into account code signs or expressions which distinguish them.

The numerical or alphabetical reference marks added to the part number, ensure the connection between these numbers and the additional information appertaining to them, included in the tables found at the bottom of the illustration or on the additional page.

Checking by Branches, Distributors or Importation Centres of an Order Form which has been filled in by an Agent or by a client using the documents in his possession.

1. In the numerical index at the part number indicated on the order form, find the corresponding plate numbers.
2. Examine these plates to check that the part number given is correct taking into account the starting points added to this number and the number of the vehicle or unit for which the part has been ordered.

Identifying by the illustration a part the number of which is known.

1. In the numerical index, at the given part number find the corresponding plate numbers.
2. Consult these plates.

GENERAL SALES CONDITIONS

See the spare parts price lists.

INTRODUÇÃO

O presente documento contém todos os conjuntos e peças isoladas vendidas como sobressalentes; Ele permite determinar com precisão os seus números e identificá-los facilmente através das ilustrações.

Estes conjuntos e estas peças estão divididas por páginas consoante o órgão ou o elemento do órgão ao qual pertencem.

Cada página é identificada por um número de 4 algarismos cujos dois primeiros correspondem a um código de órgão determinado. Quando a página se pode confundir com outra similar leva especificada a variante em questão ou um número de ponto de partida.

Um página compõe-se:

da ilustração das peças e conjuntos do órgão detalhado que diferem de forma; para cada peça ilustrada corresponde um ou vários números de peças que se caracterizam entre eles por uma variante ou um símbolo e eventualmente de quadros comportando informações complementares tais como: pontos de partida e intruções.

Estes quadros figuram seja por baixo da ilustração seja na página anexa à ilustração. Observação: a significação dos sinais e expressões codificadas utilizadas em cada página está indicada na página nº 05.01.

Um repertório das páginas ilustradas indica debaixo de cada figura representada o número da página que se pretende consultar.

No fim do catálogo existe um repertório numérico que indica a correspondência entre os números das peças e os números das páginas, assim como as quantidades de peças por veículo na página a considerar.

UTILIZAÇÃO

Determinação do número de uma peça, conhecendo a natureza da mesma.

1. Procurar no repertório das páginas, a página correspondente ao órgão ou ao elemento do órgão ao qual a peça pode pertencer.
2. Consultar o catálogo para encontrar a página tendo eventualmente em conta, o ponto de partida ou a característica variante da página.
3. Encontrando-se a página, procurar a ilustração da peça desejada. A esta ilustração corresponde um ou vários números.

Escolher aquele que convém, tendo em conta os sinais ou expressões convencionais que o acompanham.

As marcas numéricas ou alfabéticas que acompanham o número da peça asseguram a ligação entre estes números e as informações complementares contidas nos quadros situados seja em baixo da ilustração seja na página anexa.

Verificação, pelas Sucursais, Concessionários ou centros Importadores de uma nota de encomenda redigida por um Agente ou Cliente que tenha utilizado a documentação em seu poder.

1. Procurar no repertório numérico, os números das páginas correspondentes, ao número da peça dada na nota de encomenda.
2. Consultar as páginas para verificar se número da peça é aquele que convém, tendo em conta os pontos de partida correspondentes a esse número e do número do veículo ou do órgão para o qual a peça está encomendada.

Identificação pela ilustração de uma peça cujo número se conhece.







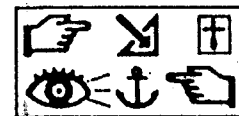

1. Procurar no repertório numérico, o número das páginas correspondentes ao número da peça dada.
2. Consultar estas páginas.

CONDIÇÕES GERAIS DE VENDA

Vêr as tarifas de peças sobressalentes.









05.01



CASTELLANO	FRANCAIS	ENGLISH	PORTUGUES
 Vehículo	Véhicule	Vehicle	Veículo
 Grupo motriz	Groupe	Power unit	Unidade motriz
 Motor	Moteur	Engine	Motor
 Caja puente o caja de cambios	Boite pont ou boite vitesse	Gearbox-transmission or gearbox	Caixa do diferencial ou caixa de mudanças
† Pieza que hay que agotar	Pièce á épulser	Use up stock	Usar até o término do estoque existente
 Una vez agotada reemplazar por	Apré épulserment, prévoir	After exhaustion of stock, supply	Após término do estoque substituir por
? = Instrucciones para la intercambiabilidad simbolizadas por	Consignes d'interchangeabilité	Interchangeability instructions symbolizes by	Indicações de intercambiabilidade
 Piezas suplementarias a proveer	Pièces á prévoir en supplément	Supplementary parts to be foreseen	Peças substitutas a serem fornecidas
 Para	Pour	For	Por
 Excepto	Sauf	Except	Exceto
 ...a...	...a...	...to...	Para









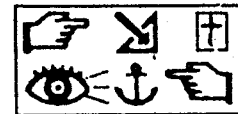

05.02

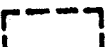

	Dirección a la izquierda	Direction à gauche	L.H. drive	Rotação a esquerda
	Dirección a la derecha	Direction à droite	R.H. drive	Rotação a direita
<input type="checkbox"/>	Equipo opcional	Equipement facultatif	Optional equipment	Equipamento opcional
	Motor Diesel	Moteur Diesel	Diesel engine	Motor Diesel
	Motor a nafta	Moteur á essence	Carburetor engine	Motor a gasolina
	Con servofreno	Avec freinage assisté	With booster brake	Com servo-freio
	Sin servofreno	Sans freinage assisté	Without booster brake	Sem servo-freio
	Piezas vendidas por cantidad determinada	Pièces vendues en quantité déterminée	Parts sold in a fixed quantity	Peças vendidas em múltiplos
#	Indica que se trata de un número de pieza de aplicación provisoria	Indique qu'il s'agit d'un chiffre provisionnel d'application	Indicates that this concerns a provisional application number	Número de peça de aplicação provisoria
&	Y	Et	And	e
	Ver lámina o ver página	Voir planche ou voir page	"See plate" or "see page"	Consultar a plaqueta ou a página
 0,00	Unidad de venta	Unité de vente	Sold in following quantities	Unidade de venda

05.03



 0,00	Venta a la longitud de fabricación	Vente en longueur de fabrication	Sold in manufactured length	Venda na medida standard do fabricante
	O bien	Ou bien	Or	Ou bem
	Condiciones especiales de cambio	Conditions spéciales d'échange	Special conditions for replacement	Condições especiais de reposição
	Ubicación de la marca en el conjunto o en la pieza	Emplacement du marquage sur l'ensemble ou la pièce	Position of the marking on the assembly or the part	Local de marca no conjunto ou da peça
	Piezas vendidas por colecciones bajo un solo número	Pièces vendues en collection sous un seul numéro	Parts sold as a kit under one par number	Peças vendidas em jogo sob um único número
	Admisión	Admission	Inlet	Admissão
	Escape	Echappement	Exhaust	Escape
	Carburador	Carburateur	Carburetor	Carburador
	Electrónico	Electronic	Electronic	Electrónico
	No electrónico	Non électronic	Mechanic	Mecanico
	Vehículo con transmisión mecánica	Véhicule á transmission mécanique	Vehicule with manual shift gearbox	Transmissão mecânica
	Vehículo con transmisión automática	Véhicule a transmission automatique	Vehicle with automatic transmission	Transmissão automática













05.06



	Calentamiento automático	Chauffage autonome	Automatic heating	Aquecimento automático
	Vehículo con aire acondicionado	Véhicule avec acondicionnement d'air	Vehicle with air conditioning	Veículo com ar acondicionado
	Vehículo sin aire acondicionado	Véhicule sans conditionnement d'air	Vehicle without air conditioning	Veículo sem ar acondicionado
	Vehículo con servo-dirección	Véhicule avec servo-direction	Vehicle with power assisted steering	Veículo com servo-direção
	Vehículo sin servo-dirección	Véhicule sans servo-direction	Vehicle without power assisted steering	Veículo sem servo-direção
	Número de dientes	Nombre de dents	Number of teeth	Quantidade de dentes
	Dentado exterior: número de dientes (ejemplo: 10 dientes)	Denture extérieure: nombre de dents (exemple: 10 dents)	External teeth: number of teeth (for example: 10 teeth)	Dentes externos: Quantidade (exemplo: 10 dentes)
	Dentado interior: número de dientes (ejemplo: 10 dientes)	Denture intérieure: nombre de dents (exemple: 10 dents)	Internal teeth: number of teeth (for example: 10 teeth)	Dentes internos: Quantidade (exemplo: 10 dentes)
	Frenos con aproximación automática de zapatas	Freins avec rattapage automatique d'usure	Brakes with self-adjusting mechanism	Freio auto-regulável
	Frenos sin aproximación automática de zapatas	Freins sans rattapage automatique d'usure	Brakes with manual adjustment	Freio de regulagem manual
	Indicador de desgaste de zapatas de frenos	Témoin nivocode - usure plaquettes	Plate wearing witness	Indicador de desgaste das sapatas do freio
	Frenado recuperativo	Freinage récupératif	Regenerative braking	Regulagem automática do freio













05.05



	Piezas a pintar	Pièces à peindre	Piece to paint	Peça sem pintura
	Carga útil indicada en kilogramos (kg)	Charge utile indiquée en kilogrammes (kg)	Load marked in kilograms (kg)	Carga útil expressa em quilos (kg)
	Traba levantavidrios	Interdiction léve-vitre AR	Window stop	Trava do mecanismo levantador dos vidros
	Indicador de freno de mano	Témoin frein á main	Hand brake witness	Indicador de freio de estacionamento
	Indicador de desgaste de pastillas de freno	Témoin usure plaquettes	Brake wear witness	Indicador de desgaste das das pastilhas do freio
	Indicador de exceso de velocidad	Dépassement de vitesse autorisé	Speed excess indicator	Indicador de excesso de velocidade
	Sintetizador de palabras	Synthétiseur de parole	Words synthetiser	Sintetizador de vozes de advertência
	Distancia entre ejes en decímetros (dm)	Empattement indiquée en décimètres (dm)	Wheelbase expressed in decametres (dm)	Distancia entre eixos (expressa em decímetros)
	Aire acondicionado	Conditionnement d'air	Air conditioning	Ar condicionado
	Acondicionador de aire	Climatiseur	Air conditioner	Ar condicionado
	Función bloqueo de diferencial	Fonction différentiel bloqué	Locked differential function	Função diferencial bloqueado
	Techo corredizo eléctrico	Toit ouvrant électrique	Electric sliding roof cover	Teto conversível eléctrico









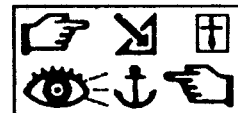



05.07



	Sin enclavamiento electromagnético de las cerraduras de las puertas	Sans condamnation electro-magnétique des serrures de portes	Without electro-magnetic door locking mechanism	Sem trava elétrica nas portas
	Con enclavamiento electromagnético de las cerraduras de las puertas	Avec condamnation electro-magnétique des serrures de portes	With electro-magnetic door locking mechanism	Trava elétrica nas portas
	Antipolución	Antipollution	Antipollution	Antipoluento
	Remoque	Remorque	Trailer	Reboque
	Vehículo equipado de una dirección variable servoasistida	Véhicule équipé d'une direction assistée variable	With variable servoassisted direction equipped vehicle	Veículos equipados com direção variável servo assistida
	Vehículo con suspensión a amortiguación piloto	Véhicule avec suspension à amortissement piloté	Vehicle with pilot Damping suspension	Veículo com suspensão e amortecedores controlados
	Vehículo sin suspensión a amortiguación piloto	Véhicule sans suspension à amortissement piloté	Vehicle without pilot Damping suspension	Veículo sem suspensão e amortecedores controlados
	Nivel de equipamiento (E0, E1, E2,....)	Niveau d'équipement (E0, E1, E2,)	Equipment level (E0, E1, E2,)	Nível de equipamento (E0, E1, E2,....)
	Amortiguador regulable	Amortisseur variable	Regulable damper	Amortecedor regulável
	Vehículo con carga útil aumentada	Véhicule avec charge utile augmentée	Vehicle with useful increased load	Veículo com carga útil aumentada
	Con air-bag	Avec air-bag	With air-bag	Com air-bag
	Sin air-bag	Sans air-bag	Without air-bag	Sem air-bag













05.08



	Con pretensionadores	Avec Pretentionneurs	With Pretensioners	Com pré-tensionador no cinto de segurança
	Sin pretensionadores	Sans Pretentionneurs	Without Pretensioners	Sem pré-tensionador no cinto de segurança
	Cinturón de seguridad	Ceinture sécurité	Security belt	Cinto de segurança
	Desempañador de espejo retrovisor exterior	Dégivrage rétroviseur extérieur	Rear view external mirror defroster	Desempanador de espelho retrovisor exterior
	Vehículo equipado con radio teléfono	Véhicule équipé radio téléphone	Radio-telephone equipped vehicle	Veículo equipado com rádio telefone
	Vehículo no equipado con radio teléfono	Véhicule non équipé radio téléphone	Non equipped vehicle with radio-telephone	Veículo nao equipado com rádio telefone
	Alarma sonora	Alarme sonore	Acoustic alarm	Alarme sonoro
	Contactador de prueba 3 testigos	Contacteur test 3 témoins	Test contactor witness	Contador de prova 3 indicadores
	Comando de radio	Commande radio	Radio remote control	Comando do rádio
	Temporizador	Temporisateur	Temporized	Temporizador
	Encendedor de cigarrillos	Allume-cigares	Cigarettes lighter	Acendedor de cigarros
	Arranque	Démarrage	Starter	Partida









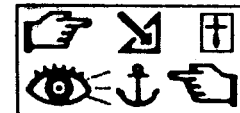



05.09



	Bocina	Avertisseur	Horn	Buzina
	Nafta con plomo	Essence avec plomb	Petrol with lead	Combustível com chumbo
	Nafta sin plomo	Essence sans plomb	Petrol without lead	Combustível sem chumbo
	Con lectura de disco compacto	Avec lecteur de disque compact	With compact disc reading	Com leitor de compact disc
	Sin lectura de disco compacto	Sans lecteur de disque compact	Without compact disc	Sem leitor de compact disc
	Levantavidrio eléctrico	Lève-vitre électrique	Electric window lifter	Mecanismo levantador elétrico
	Levantavidrio a impulsión	Lève-vitre impulsion	Mechanical window lifter	Levantador impuls. dos vidros
	Levantavidrio mecánico	Lève-vitre mécanique	Mechanical window lifter	Mecanismo levantador mecánico
	Levantavidrio eléctrico	Lève-vitre électrique	Electric window lifter	Mecanismo levantador elétrico
	Desempañador	Déssembuage	Demister screen	Desembaçador
	Parabrisas laminado	Pare-brise feuilleté	Laminiated windscreen	Pára-brisas laminado
	Parabrisas templado	Pare-brise trempé	Toughened windscreen	Pára-brisas temperado









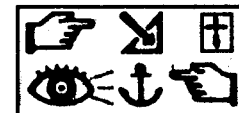



05.10



	Vidrios incoloros	Vitres incolores	Clear glass	Vidros incolores
	Vidrios polarizados	Vitres teintées	Tinted glass	Vidros coloridos
	Desempañador de luneta trasera	Desembuage lunette arrière	Rear screen demistint	Desembaçador do vidro traseiro
	Combustible	Carburant	Fuel	Combustível
	Volante de altura regulable	Volant réglable en hauteur	Height regulated driving wheel	Volante da direção regulável
	Reóstato (todos los tipos)	Rhéostat (tous types)	Rheostat (all types)	Reostato (todos os tipos)
	Filtro de gasoil	Filtre á gazole	Gas oil filter	Filtro de gasolina
	Indicador de giro	Indicateur direction	Course indicator	Indicador de direção
	Detector de temperatura exterior	Détecteur de température extérieure	Outside thermometer	Indicador de temperatura externa
	Con corte de inyección	Avec coupure injection	With injection cut off	Com corte de injeção de combustível
	Sin corte de inyección	Sans coupure injection	Without injection cut off	Sem corte de injeção de combustível
	Venta por metro	En bobine vendu au mètre	Coil sales by meter unit	Vendida por metro













05.11



	Indicador de carga	Indicateur de charge	Charge indicator	Indicador da carga da bateria
	Limpia-lavafaros	Essuie & lave phare combiné	Light cleaner combination	Lavador dos faróis
	Proyector regulable	Réglage projecteur	Adjusting light	Farol regulável
	Luz antiniebla	Feu brouillard avant	Anti-fog light	Farol de neblina
	Luz antiniebla trasera	Feu brouillard arrière	Rear anti-fog light	Lanterna traseira de neblina
	Luz de marcha atrás	Phare de recul	Back up light	Luz da marcha ré
	Plafón	Plafonnier seul	Ceiling lamp	Iluminação interna
	Luz spot	Plafonnier spot	Ceiling light	Iluminação traseira de neblina
	Iluminación	Eclairage	Illumination	Iluminação
	Luz de cruce	Feu de croisement	Anti-clare light	Farol anti ofuscante
	Proyector de largo alcance	Projecteur longue portée	Long range driving light	Farol de milha
	Luz de emergencia	Signal de détresse	Distress signal	Luz de emergência

05.12



	Lavaparabrisas	Lave-vitre	Glass washer	Lavador do pára-brisa
	Limpia-lavaparabrisas	Essuie & lave vitre-combiné	Glass cleaner and whipper combination	Limpador de pára-brisa
	Nivel de agua de lavaparabrisas	Niveau lave-vitre	Glass washer level	Nível de água do lavador de pára-brisa
	Limpiaparabrisas	Essuie-vitre	Whipper	Limpador do pára-brisa
	Lavaluneta trasera	Lave-lunette A.R.	Back window washer	Lavador do vidro traseiro
	Limpialuneta trasera	Essuie-lunette A.R.	Back window cleaner	Limpador do vidro traseiro
	Limpia-lavaluneta trasera combinada	Essuie et lave-lunette A.R. combiné	Back window cleaner and whipper combination	Limpador-lavador do vidro traseiro combinado
	Luz de estacionamiento	Lanterne parking	Parking light	Luz de estacionamiento
	Caja de cambios	Boîte de vitesses	Gearbox	Caixa de mudanças
	Caja puente o caja de cambios con mandos en tablero	Boîte-pon ou boîte de vitesses avec commandes à la planche de bord	Gearbox-transmission or gearbox with dashboard mounted gear shift	Transmissão com avalança no painel
	Caja puente o caja de cambios con mandos en el piso	Boîte-pont ou boîte de vitesses avec commandes au plancher	Gearbox-transmission or gearbox with floor mounted gear shift	Transmissão com avalança no assoalho
	3 velocidades	3 vitesses	3 speed	3a. velocidades











05.13



4	4 velocidades	4 vitesses	4 speed	4a. velocidades
5	5 velocidades	5 vitesses	5 speed	5ª velocidades
1	1ª velocidad	1 vitesse	1st. speed	1ª velocidades
2	2ª velocidad	2 vitesse	2nd. speed	2ª velocidades
3	3ª velocidad	3 vitesse	3rd. speed	3ª velocidades
4	4ª velocidad	4 vitesse	4th. speed	4ª velocidades
5	5ª velocidad	5 vitesse	5th. speed	5ª velocidades
12	1ª y 2ª velocidades	1 et 2 vitesses	1st. and. 2nd. speeds	1ª e 2ª velocidades
23	2ª y 3ª velocidades	2 et 3 vitesses	2nd. and 3rd. speeds	2ª e 3ª velocidades
34	3ª y 4ª velocidades	3 et 4 vitesses	3rd. and. 4th. speeds	3ª e 4ª velocidades
45	4ª y 5ª velocidades	4 et 5 vitesses	4th. and. 5th. speeds	4ª e 5ª velocidades
R	Marcha atrás	Marche arrière	Reverse	Marcha-ré









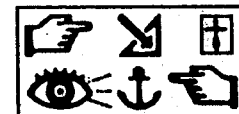



05.14



	1ª velocidad - marcha atrás	1 vitesse - marche arrière	1st. speed - Reverse	1a. velocidade / marcha-ré
	Manómetro	Manomètre	Manometer	Manômetro
	Economizador	Economètre	Econometer	Economizador
	Taquímetro	Tachygraphe	Taquigraph	Conta-giros
	Vehículo con cuenta vueltas	Véhicule avec compte-tours	Vehicle with tachometer	Veículo com tacômetro
	Vehículo sin cuenta vueltas	Véhicule sans compte-tours	Vehicle without tachometer	Veículo sem tacômetro
	Antipercolación	Anti percolation	Anti percolation	Ventilação automática
	Temperatura de agua	Temperatura d'eau	Water temperature	Temperatura de água
	Temperatura del aceite	Température d'huile	Oil temperature	Temperatura do óleo
	Nivel de agua	Niveau eau moteur	Water level	Nível de água
	Nivel de aceite	Niveau d'huile	Oil level	Nível de óleo

05.15



	Indicador de inyección de combustible	Pilotage injection	Fuel injection advertiser	Indicador de injeção de combustível
	Indicador de funcionamiento de termocontacto	Thermistance pour indicateur sur cadran	Instrument panel indicator thermoswitch	Indicador de funcionamento de termocontacto
	Indicador luminoso de presión de aceite	Pression d'huile pour voyant lumineux (alerte)	Light for oil pressure (alarm)	Indicador luminoso de pressão de óleo
	Indicador de presión de aceite	Pression d'huile pour indicateur sur cadran	Instrument panel oil indicator	Indicador de pressão de óleo
	Presión del aceite	Pression d'huile	Oil pressure	Pressão do óleo
	Motoventilador comandado por termocontacto	Termocontact pour le déclenchement du G.M.V.	G.M.V. starting thermoswitch	Motoventilador dirigida por termocontacto
	Termocontacto de accionamiento de bomba eléctrica	Thermocontact déclenchement Pompe électrique	Electric bomb activation thermocontact	Termocontacto de acionamento da bomba eléctrica
	Sistema electrónico de fallas (caja de velocidades automática)	Défail système électronique (B.V.A. Inj. électr.)	Electronic system detail (G.B.A.T. Electronic inj.)	Sistema eletrônico de falhas (caixa de velocidades automática)
	Indicador de fallas de filamentos	Défil	Filaments failure indicator	Detector de falhas eléctricas
	Traba electromagnética central	Verrouillage central electro-magnétique	Electromagnetic central locking device	Trava central electromagnética
	Asiento de altura regulable	Siège réglable en hauteur	High regulated seat	Banco com altura regulável
	Asiento de conductor fijo	Siège "captain chair" socle fixe	"Captain chair" seat fixed platform	Banco do motorista - fixo



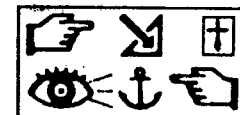









05.16



C	Asiento de conductor reclinable	Siège "captain chair" socle pivotant	"Captain chair" seat pivoting platform	Banco do motorista - reclinável
D	Asiento trasero basculante con respaldo abatible	Banquette AR basculante, dossier rabattable	Pivoting back seat	Banco traseiro reclinável
E	Asiento trasero 3 plazas; 1 fijo y 2 abatibles	Banquette AR 3 places 1 dossier fixe 2 dossiers rabattable	Rear seat 3 places 1 fixe back and 2 moving back	Banco traseiro 3 lugares 1 fijo e 2 abatíveis
F	Asiento trasero con 3 plazas abatibles	Banquette AR 3 places 3 dossier rabattable	Rear seat moving 3 places	Banco traseiro com 3 lugares abatíveis
G	Asiento trasero 1/3 - 2/3	Banquette AR fonctionnalité 1/3 - 2/3	Rear seat 1/3 - 2/3	Banco traseiro 1/3 - 2/3
H	Asiento trasero 1/1	Banquette AR fonctionnalité 1/1	Rear seat 1/1	Banco traseiro 1/1
K	2 filas de asientos tipo break	2 rangées de sièges type break	Two row seats break type	2 filas de bancos tipo break
L	3 filas de asientos tipo familiar	3 rangées de sièges type familiale	3 row seats family type	3 filas de bancos tipo familiar
M	Vehículo equipado con asientos eléctricos con memoria	Véhicule équipé de sièges élec. avec mémorisation	Electric seats equipped car with electric seats with memory	Veículos equipados com bancos elétricos com memória
N	Vehículo equipado con asientos eléctricos sin memoria	Véhicule équipé de sièges élec. sans mémorisation	Electric seats without memory equipped vehicle	Para veículos equipados com bancos elétricos sem memória
P	Asientos con movimientos mecánicos	Sièges à débattement mécanique	Seats with mechanic movements	Bancos com regulagem mecânica
R	Asientos con movimientos eléctricos	Sièges à débattement électrique	Seats with electric movements	Bancos com regulagem elétrica

05.17



	Vehículos con asientos ergonómicos	Véhicules avec sièges ergonomiques	Vehicles with ergonomic seats	Veículos com assentos ergonómicos
	Vehículos sin asientos ergonómicos	Véhicules sans sièges ergonomiques	Vehicles without ergonomic seats	Veículos sem assentos ergonómicos
	Asiento calefaccionado	Siège chauffant	Warmed seat	Banco com calefação
	Regulación de altura de asiento	Réglage hauteur siège	Seat height control	Regulação de altura de banco
	Regulación de asiento adelante-atrás	Réglage siège avant-arrière	Front-rear seat regulation	Regulação de banco P/frente-atrás
	Regulación de respaldo	Réglage dossier siège	Seat back control	Regulação de encosto
	Respaldo fijo	Dossier fixe	Fixed seat back	Encosto fixo
	Respaldo regulable	Dossier réglable	Adjustable seat back	Encosto regulável
	Respaldo inclinable (asiento transformable en cama)	Dossier inclinable (couchette)	Reclining seat back (travel bed)	Encosto inclinável
	Banqueta delantera	Banquette avant	Front bench seat	Banco dianteiro
	Asientos delanteros separables	Sièges avant séparés	Separate front seats	Bancos dianteiros separados
	Respaldo rebatible	Dossier rabattable vers l'avant	Revolving seat back	Encosto rebatível



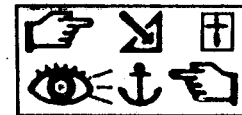

05.18

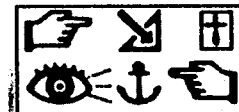

7	Asientos separados de respaldo fijo tipo microómnibus	Siéges séparés type microcar à dossier fixe	Separate seats with fixed seat back	Bancos separados de encosto fixo
8	Butaca delantera basculante de respaldo fijo	Banquette avant basculante dossier fixe	Pivoting fixed front seat	Banco dianteiro basculante con encosto fixo
9	Asiento 2 plazas basculante con respaldo rebatible	Banquette 2 places basculante dossier rabattable	2 places seat pivoting seat back	Banco duplo com encosto reclinável
1	Acero	Acier	Steel	Aço
2	Latón	Laiton	Brass	Latão
3	Cobre	Cuivre	Copper	Cobre
4	Nilón	Nylon	Nylon	Nylon
5	Acero inoxidable	Acier inoxydable	Stainless steel	Aço inoxidável
6	Aluminio	Aluminium	Aluminium	Alumínio
7	Tapizado símil cuero	Sellerie simili	Leathercloth upholstery	Estofado de courvin
8	Tapizado paño	Sellerie tissu	Gloth upholstery	Estofado de tecido
9	Percal	Percalé	Coated cambric muslin	Tecido de algodao













05.19



10	Afombrilla	Moquette	Carpeting	Carpete
11	Fieltro	Feutre	Feit	Feltro
12	Lona para toldo	Toile a bache	Tilt canvas	Encerado
13	Tapizado cuero	Sellerie cuir	Leather upholstery	Estofado de couro
14	Fundición	Fonte	Cast	Fundido
15	P.V.C.	P.V.C.	P.V.C.	P.V.C.
16	Boucle	Bouclée	Boucle	Boucle
18	Caucho	Caoutchoue	Rubber	Borracha
	Para brazo de suspensión en acero	Pour bras suspension en acier	For suspension steel arm	Para uso em suspensão com braço de aço
	Para vehículos equipados con llantas de aluminio	Pour véhicules équipés de jantes aluminium	For aluminium wheel rims manufactured vehicles	Para vehculos equipados com rodas de alumínio
	Para tapizado de imitación cuero	Pour sellerie simili	For tapestry made of imitation of leather	Para forração imitação em couro
	Para tapizado de tela	Pour sellerie tissus	For material made tapestry	Para forração de tecido













05.20



	Para tapizado de techo de tela	Pour garniture pavillon percale	For material made ceiling tapestry	Para forração do teto em "percale"
	Para tapizado de cuero	Pour sellerie cuir	For leathered tapestry	Para forração de couro
	Para brazo de suspensión de fundición	Pour bras suspension en fonte	For melding suspension arm	Para uso em suspensão com braço fundido
	Para vehículos equipados con llantas de chapa	Pour véhicules équipés de jantes tôle	For hoops-hiron equipped vehicles	Para veículos equipados com rodas estampadas
	Vidriado	Vitrée	Windowed	Carroçeria com janelas traseiras
	Cerrado	Tôlée	Closed	Carroçeria sem janelas traseiras
	Apertura de baúl	Ouverture capot arriere	Trunk lid opening	Abertura de porta malas
	Apertura de capot	Ouverture capot avant	Bonnet louver	Abertura de cofre
	Con tabique de retención de equipajes	Avec cloison de retenue des bagages	With a thin wall of luggage retention	Separador para retenção de bagagens
	Versión de gran lujo, asientos delanteros con respaldo inclinables con apoyabrazos central trasero (TL)	Grand luxe, siège avant à dossier inclinable, avec accoudoir central arrière (TL)	Grand luxe version with reclining front-seat (TL) and central arm rest.	Versão grande luxo, assento dianteiro com encosto inclinável e descansabrazo central trazeiro (TL)
	Limusina "Lujo"	Limousine "Luxe"	Limousine "Luxe"	Limusine "Luxo"
	Versión sin desempañado eléctrico de la luneta trasera	Version sans désembuage électrique lunette arriere	Version without electric rear window demister	Versão sem desembaçador do vidro traseiro









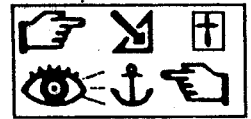



05.21



	Con portezuela superior trasera	Avec girafon	With upper rear flap	Com porta superior traseira
	Sin portezuela superior trasera	Sans girafon	Without upper rear flap	Sem porta superior traseira
	Furgoneta sin cristales con portezuela en el techo	Fourgonnette tôlée avec trappe de pavillon	Plain sided van with roof flap	Furgão fechado com abertura no teto
	Furgoneta con cristales con abertura en el techo	Fourgonnette vitrée avec trappe de pavillon	Van with side windows and roof flaps	Furgão com vidros e abertura no teto
	Vehículo equipado con asiento trasero	Véhicule équipé de banquette arrière	Rear bench seat equipped vehicle	Veículo equipado com assento traseiro
	Vehículo no equipado con asiento trasero	Véhicule non équipé de banquette arrière	Non rear bench seat equipped vehicle	Veículo não equipado com assento traseiro
	Furgoneta sin cristales con portezuela en el techo sin asiento trasero	Fourgonnette tôlée avec trappe de pavillon sans banquette arrière	Plain sided van with roof flap, without rear bench seat	Furgão fechado com abertura no teto sem banco traseiro
	Furgoneta sin cristales con portezuela en el techo con asiento trasero	Fourgonnette tôlée avec trappe de pavillon avec banquette arrière	Plain sided van with roof flap, and rear bench seat	Furgão fechado com abertura no teto com banco traseiro
	Pick-up	Pick-up	Pick-up	Pick-up
	Furgoneta	Fourgonnette	Van	Furgão
	Furgón sin cristales techo normal	Fourgon tôle toit normal	Plain-sided van with normal roof	Furgão fechado de teto normal
	Techo sobreelevado	Pavillon surélevé	High roof van	Teto sobreelevado













05.22



	Furgón mixto techo normal	Fourgon mixte toit normal	Universal van with normal roof	Furgão misto teto normal
	Microbús 8/9 plazas con techo sobreelevado	Fourgon mixte - Microcar 8/9 places toit surélevé	Universal van elevated roof	Furgão - 8/9 lugares com teto elevado
	Furgón acristalado techo normal 8/9 plazas	Fourgon vitré - Microbus 9 places Tourisme 8 places toit normal	Van with side windows and normal roof	Furgão - 8/9 lugares com janelas laterais e teto normal
	Furgón acristalado 12 plazas techo sobreelevado	Fourgon vitré - Microcar 12 places toit surélevé	Window van microcar 12 seats elevated roof	Furgão - 12 lugares com janelas laterais e teto elevado
	Carrocería de largo normal	Plateau cabine standard	Cab standard floor	Carroçeria normal
	Carrocería larga	Plateau cabine allongué	Cab elongated floor	Carroçeria alongada
	Piso cabina	Plancher cabine - Chassis cabine	Cab floor panel	Assoalho da carroçeria
	Puerta lateral corrediza	Porte latérale coulissante	Sliding side door	Porta lateral corredeira
	Puerta lateral vaivén	Porte latérale battante	Hinged side door	Porta lateral articulada
	Puerta trasera de vaivén	Porte arrière battante	Hinged rear door	Porta traseira articulada
	Compuerta trasera	Hayon	Rear half door	Porta traseira
	Puertas de carga 3 partes	Portes marchandes 3 vantaux	Load doors three parts	Porta de carga em tres partes









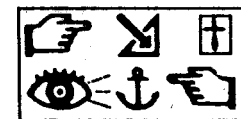



05.23



 15	Vehículo con corrector de altura	Véhicule avec correcteur d'assiette	Vehicle with height corrector	Veículo com regulagem do assento do banco
 16	Vehículo sin corrector de altura	Véhicule sans correcteur d'assiette	Vehicle without height corrector	Veículo sem regulagem do assento do banco
 17	Venta especial	Affaire société	Special purchase	Venda governamental
 E	Con cinturones de seguridad eléctricos	Avec ceintures de sécurité électriques	With electric security belt	Com cintos de segurança elétricos
 M	Sin cinturones de seguridad eléctricos	Sans ceintures de sécurité électriques	Without electric security belt	Sem cintos de segurança elétricos
	Versión techo normal	Versión toit normal	Standard roof version	Versão teto normal
	Versión techo corredizo	Version toit ouvrant	Sonroof version	Versão teto solar
 0	Vehículo sin designación comercial aparte del monograma	Véhicule sans appellation commerciale derrière le monogramme	Vehicle without comercial designation besides the monogram	Veículo sem designação comercial além do monograma
 1	Custom / de base	Custom / de base	Custom / of base	Veículo básico
 2	De lujo	De luxe	Luxe	De luxo
 3	Limitado	Limited	Limited	Limitado
 B	Vehículo con protecciones laterales	Véhicule avec protections latérales	Sided protected vehicle	Veículo com proteção lateral









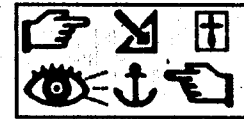



05.24



 S	Vehículo sin protecciones laterales	Véhicule sans protections latérales	Vehicle without sided protections	Veículo sem proteção lateral
 J	Vehículo con cápsula catalítica	Véhicule avec pot catalytique	Vehicle with catalytic capsule	Veículo com conversor catalítico
 K	Vehículo sin cápsula catalítica	Véhicule sans pot catalytique	Vehicle without catalytic capsule	Veículo sem conversor catalítico
 14	Caja con toldo	Plateau bâché	Box with canvas	Chassi plataforma
 15	Piso de cabina en bajo nivel	Plateau cabine surbaissé	Floor of cabinet lower level	Chassi plataforma rebaixado
	Plataforma desnuda	Pick-up	Platform only	Furgão com plataforma para cargas
	Chasis	Châssis	Chassis	Chassis
	Vehículo de tracción	Véhicule á traction	Front wheel drive	Veículo com tração dianteira
	Vehículo de propulsión	Véhicule á propulsion	Rear wheel drive	Veículo com tração traseira
	Furgón con el techo superalto	Fourgon tôle pavillon surélevé	High roof van	Furgão com teto sobreelevado
	Microbús con el techo normal	Microcar á pavillon normal	Standard roof bus	Microônibus com teto normal
	Ambulancia	Ambulance	Ambulance	Ambulância





05.25



	Excepto ambulancia	Sauf ambulance	Except ambulance	Exceto ambulância
	Furgón con puerta corrediza enchapada y puertas traseras de vaivén	Fourgon á porte coulissante tôleé	Van with sliding side door and hinged rear door	Furgão com porta lateral corredeira e porta tras. articulada
	Furgón con puerta lateral corrediza acristalada y puerta trasera de vaivén	Fourgon á porte coulissante vitrée	Van with sliding side door and window and hinges rear doors	Furgão com porta lateral corredeira (c/janelas) e porta tras. articulada
	Furgón con puerta lateral vaivén	Fourgon á porte battante tôleé	Closed hinged door van	Furgão com porta lateral articulada
	Furgón con puerta lateral corrediza enchapada con portón	Fourgon á porte coulissante tôleé avec hayon arriére	Van with plain sliding side door and tailgate	Furgão com porta lateral corredeira e porta traseira articulada
	Furgón con puerta lateral corrediza acristalada con portón	Fourgon á porte coulissante vitrée avec hayon arriére	Van with sliding side door and window and tailgate	Furgão com porta lateral corredeira (c/janelas) e porta tras. articulada
	Furgón puerta lateral vaivén con portón	Fourgon á porte battante tôleé avec hayon arriére	Covered revolving door van with detachable rear cover	Furgão com porta lateral articulada e porta traseira removível
	Furgón puerta lateral vaivén acristalada con portón	Fourgon á porte battante vitrée avec hayon arriére	Glassed revolving door van with detachable rear cover	Furgão com porta lateral de janelas e porta traseira removível
	Furgón sin puerta lateral, con puerta trasera de vaivén	Fourgon sans porte latérale avec portes battantes arriére	Van with plain sides and hinged rear door	Furgão com laterais fechadas e porta traseira articulada
	Furgón sin puerta lateral con portón	Fourgon sans porte latérale avec hayon arriére	Van without side door but with rear cover	Furgão com laterais fechadas e tampa traseira
	Vehículo con techo ventilado	Véhicule avec trappe d'aération	Ventilated covered vehicle	Furgão de teto ventilante
	Vehículo sin techo ventilado	Véhicule sans trappe d'aération	Vehicle without ventilation cover	Furgão de teto normal

05.26



 Furgoneta todos tipos	Fourgon tous types	Van - all types	Furgoneta - todos os tipos
 Transportes abiertos todos tipos	Transports ouverts tous types	Platform trucks - all types	Veículo com chassi sem carroçeria
 Vehículo con caja	Benne	Truck	Caminhão basculante
 Furgón sin cristales techo normal	Fourgon tôlé pavillon normal	Plain-sided van with normal roof	Furgão fechado de teto normal
[] Señal color	Repere couleur	Colour mark	Marca da cor
[1] Plateado	Chrome	Chrome	Cromado
[2] Dorado	Or	Gold	Dourado
[3] Blanco	Blanc	White	Branco
[4] Gris intermedio	Gris moyen	Medium grey	Cinza médio
[5] Negro	Noir	Black	Preto
[6] Azul	Bleu moyen	Medium blue	Azul médio
[7] Azul claro	Bleu clair	Light blue	Azul claro

05.27

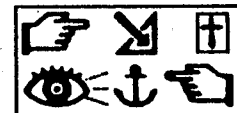

[8]	Verde	Vert moyen	Medium green	Verde médio
-----	-------	------------	--------------	-------------

[9]	Verde claro	Vert clair	Light green	Verde claro
-----	-------------	------------	-------------	-------------

[10]	Verde oliva	Vert olive	Olive green	Verde azeitona
------	-------------	------------	-------------	----------------

[11]	Amarillo	Jaune	Yellow	Amarelo
------	----------	-------	--------	---------

[12]	Naranja	Orange	Orange	Laranja
------	---------	--------	--------	---------

[13]	Marrón oscuro	Marron foncé	Dark maroon	Castanho escuro
------	---------------	--------------	-------------	-----------------

[14]	Marrón claro	Marron clair	Light maroon	Castanho claro
------	--------------	--------------	--------------	----------------

[15]	Beige intermedio	Beige moyen	Medium beige	Bege médio
------	------------------	-------------	--------------	------------

[16]	Rojo intermedio	Rouge moyen	Medium red	Vermelho médio
------	-----------------	-------------	------------	----------------

[17]	Rosa	Rose	Pink	Cor-de-rosa
------	------	------	------	-------------

[18]	Violeta	Violet	Violet	Violeta
------	---------	--------	--------	---------

[19]	Lila	Mauve	Mauve	Malva
------	------	-------	-------	-------

05.28



[20]	Rojo oscuro	Rouge foncé	Dark red	Vermelho escuro
[21]	Gris claro	Gris clair	Light grey	Cinza claro
[22]	Gris oscuro	Gris foncé	Dark grey	Cinza escuro
[23]	Beige claro	Beige clair	Light beige	Bege claro
[24]	Beige oscuro	Beige foncé	Dark beige	Bege escuro
[25]	Marrón intermedio	Marron moyen	Medium maroon	Castanho médio
[26]	Crema	Crème	Cream	Creme
[27]	Marfil	Ivoire	Ivory	Marfim
[28]	Sepia	Sépia	Sepia	Sépia
MOD	Seguido del año comercial, indica el año del modelo en espera de las cifras	Suivi du millésime, indique l'année du modelo en attente des chiffres d'application	Followed by year of manufacture indicates model year pending issue of application numbers	Seguido do milésimo indique o ano do modelo esperando pelos algarismos de aplicação
T	Código de tapizado	Code couleur garniture	Upholstery colour code	Código de cores de estofado
A	Amperio	Ampère	Ampere	Ampere

05.29

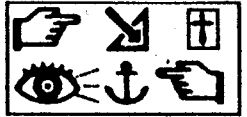

V Voltios

Volts

Volts

Volts

W Vatio

Watt

Watt

Watt

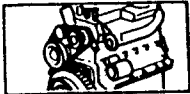

10.01

P.R. 1233

10.01

P.R. 1233



- 1- 77 02 086 624 (a)
- 77 02 087 194 (b)
- 77 02 087 235 (d)
- 77 02 087 034 (e)
- 77 02 087 250 (f)
- 77 02 087 249 (c)
- 2- 77 02 206 610 (a)(b)(c)(f)
- 77 02 206 800 (d)(e)

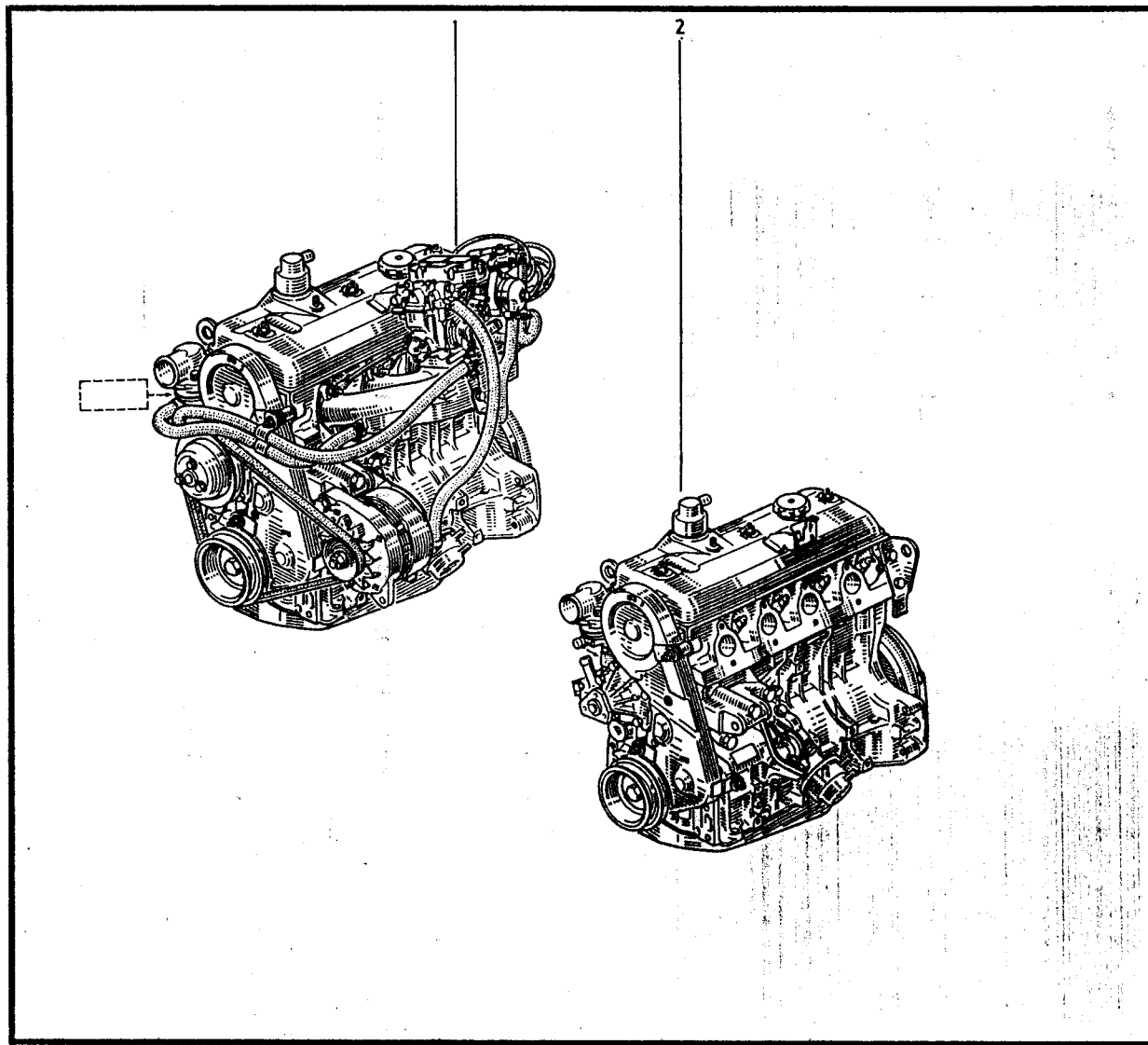

	K487 089		
(a)	K48S 090/092 L48S 091	(c)	K488 089 L488 089
(b)	K48S 204/210 L48S 208	(d)	L489 212 K489 212
		(e)	L489 089 K489 089/093
		(f)	K488 202 L488 202



10.01.1
P.R. 1233

1- 77 02 217 032
2- 77 02 087 286

Injection

10.01.1
P.R. 1233

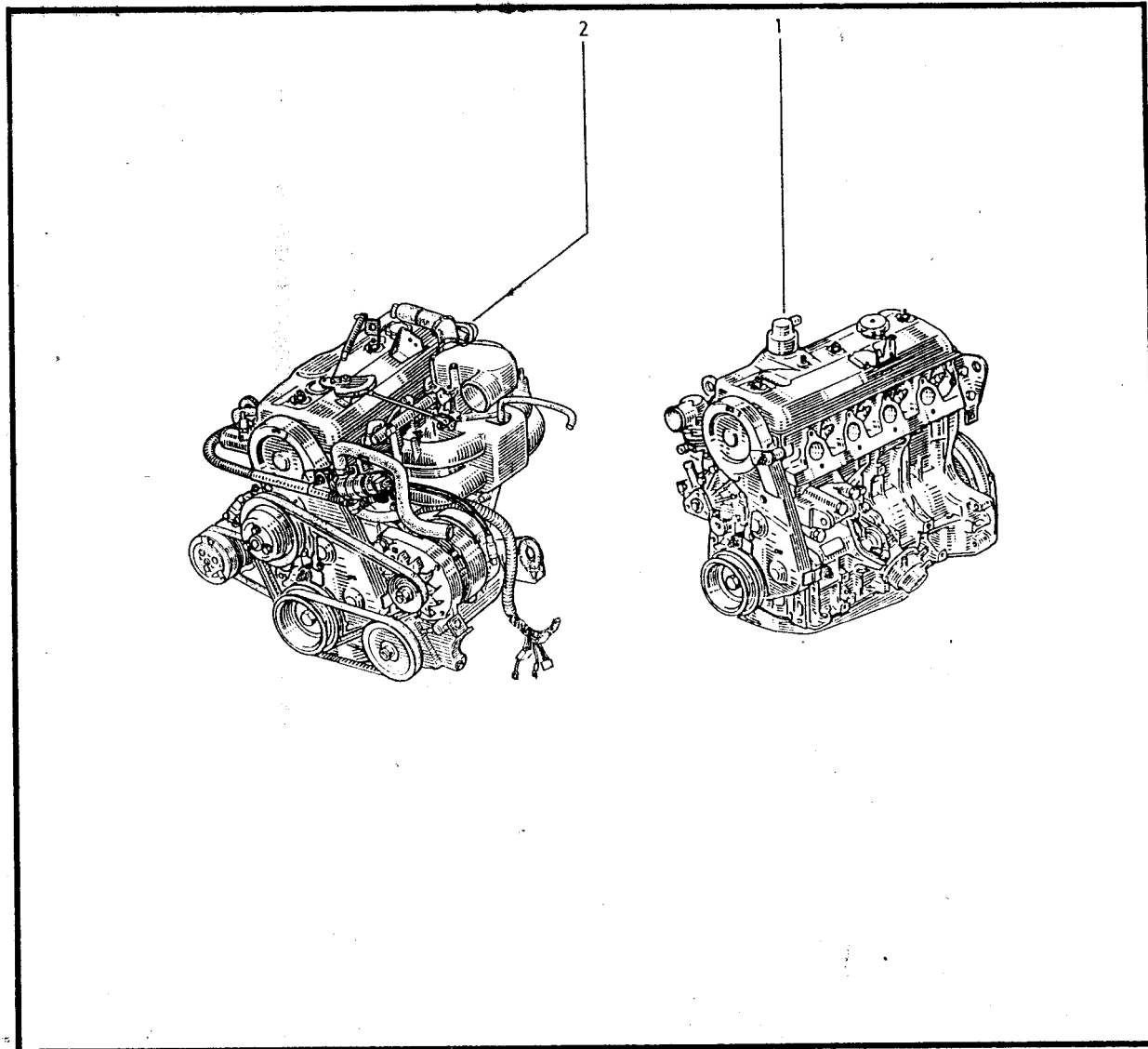
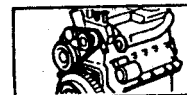

K48Y 092/090
L48Z 091/095
L48Y 091



10.01

P.R. 1233

10.01

P.R. 1233

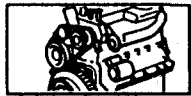

- 1- 77 02 086 624 (a)
- 77 02 087 194 (b)
- 77 02 087 235 (d)
- 77 02 087 034 (e)
- 77 02 087 250 (f)
- 77 02 087 249 (c)
- 2- 77 02 206 610 (a)(b)(c)(f)
- 77 02 206 800 (d)(e)

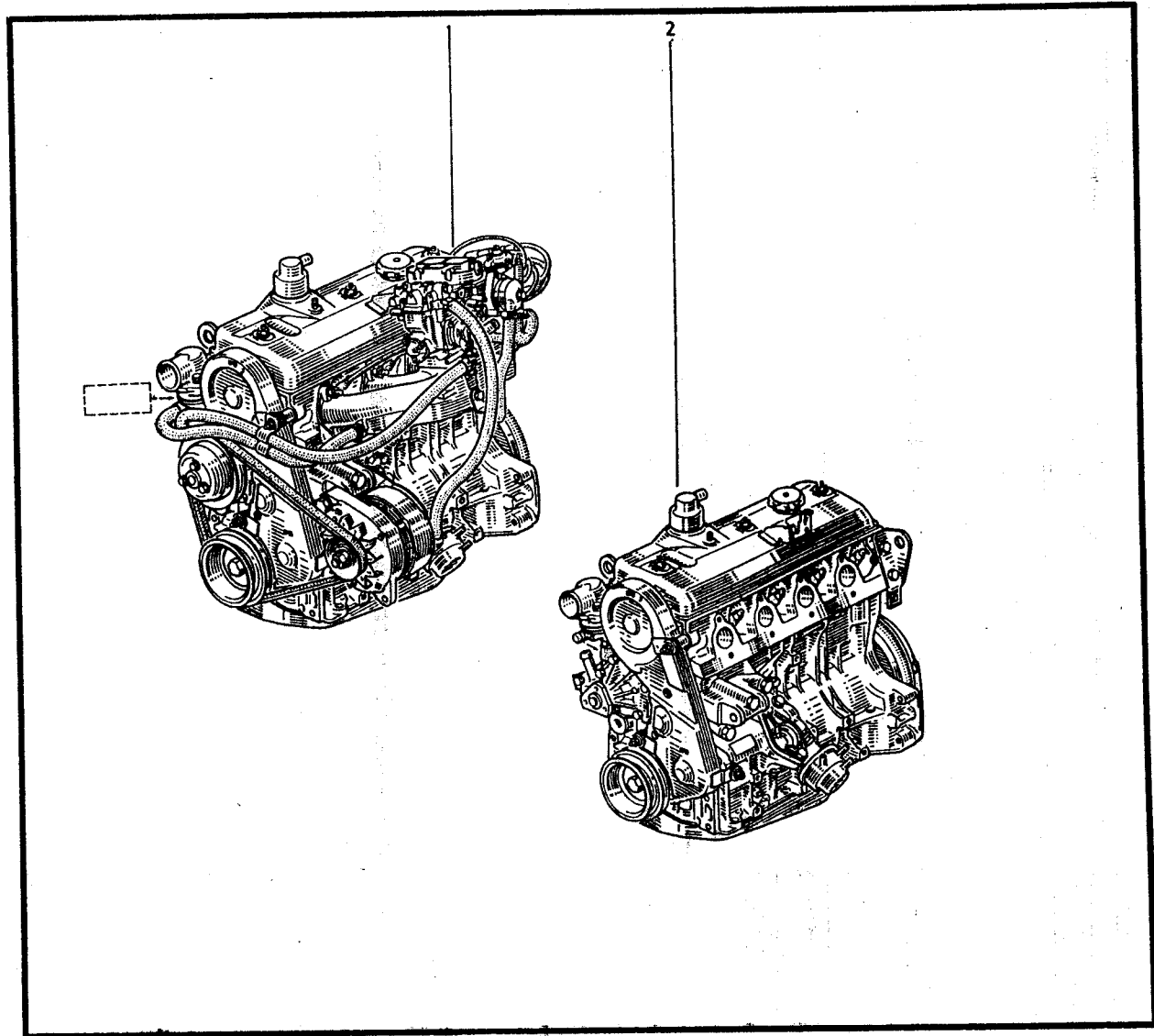

K487 089		
(a) / K48S 090/092 L48S 091	(c) / K488 089 L488 089	(e) / L489 089 K489 089/093
(b) / K48S 204/210 L48S 208	(d) / L489 212 K489 212	(f) / K488 202 L488 202

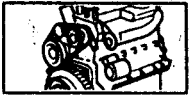

10.01.1
P.R. 1233

1- 77 02 217 032
2- 77 02 087 286

Injection

10.01.1
P.R. 1233

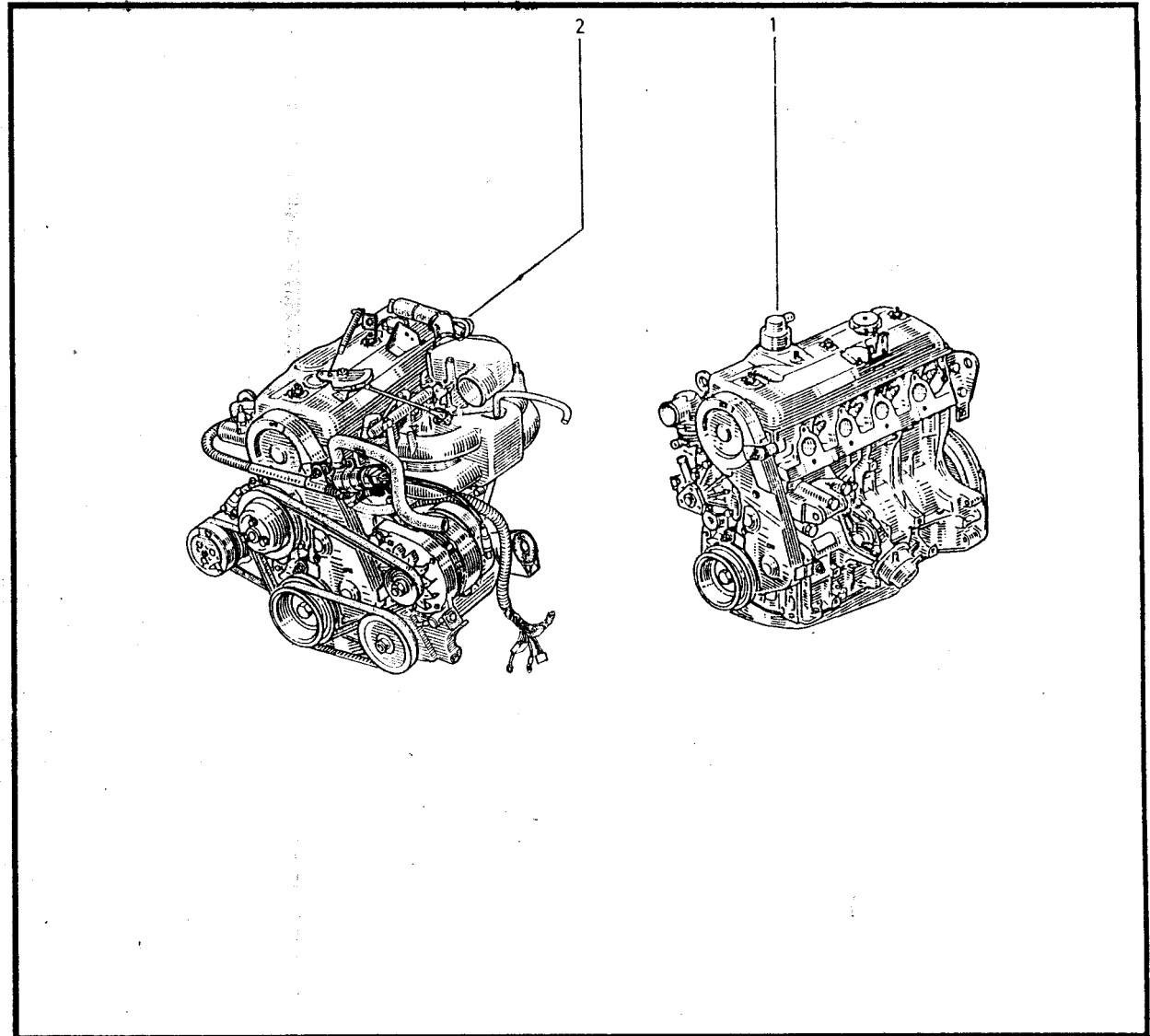
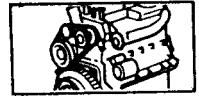

K48Y 092/090
L48Z 091/095
L48Y 091

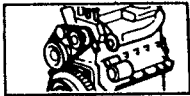

10.01.2

P.R. 1233

10.01.2

P.R. 1233



Injection

- 1- 77 02 087 287 (a)
- 2- 77 02 220 570 (b)
- 3- 77 02 217 036

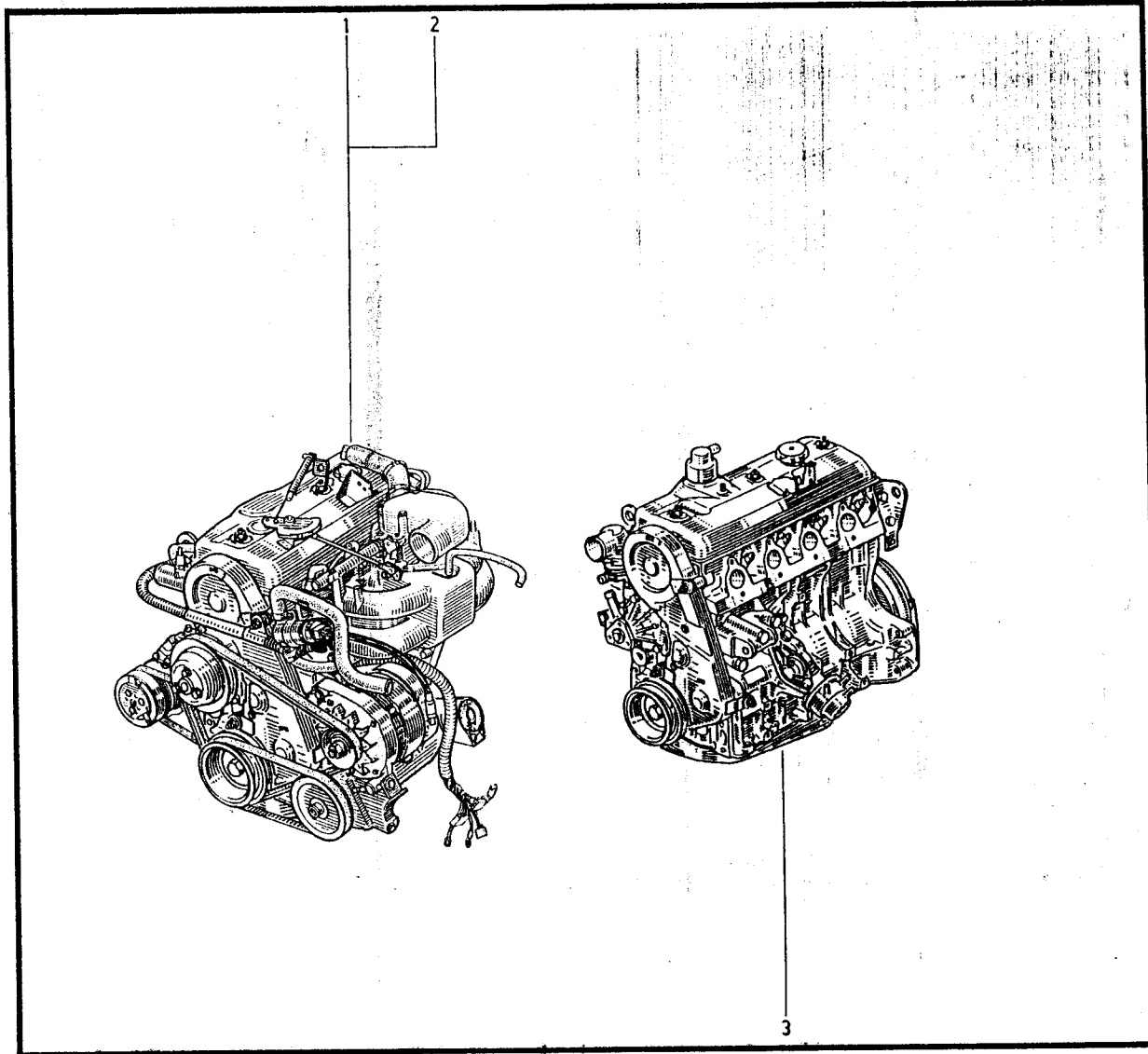

(a)	K48X 210
	L48K 208/209
	L48X 208

(b)	L48G 202
	L48G 202

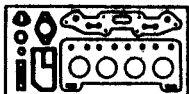

10.15

P.R. 1233

- 1- 77 02 206 404 †
- 77 02 217 454
- 2- 77 02 089 541 †
- 77 02 217 533
- 3- 77 02 206 407
- 4- 77 01 464 133

10.15

P.R. 1233

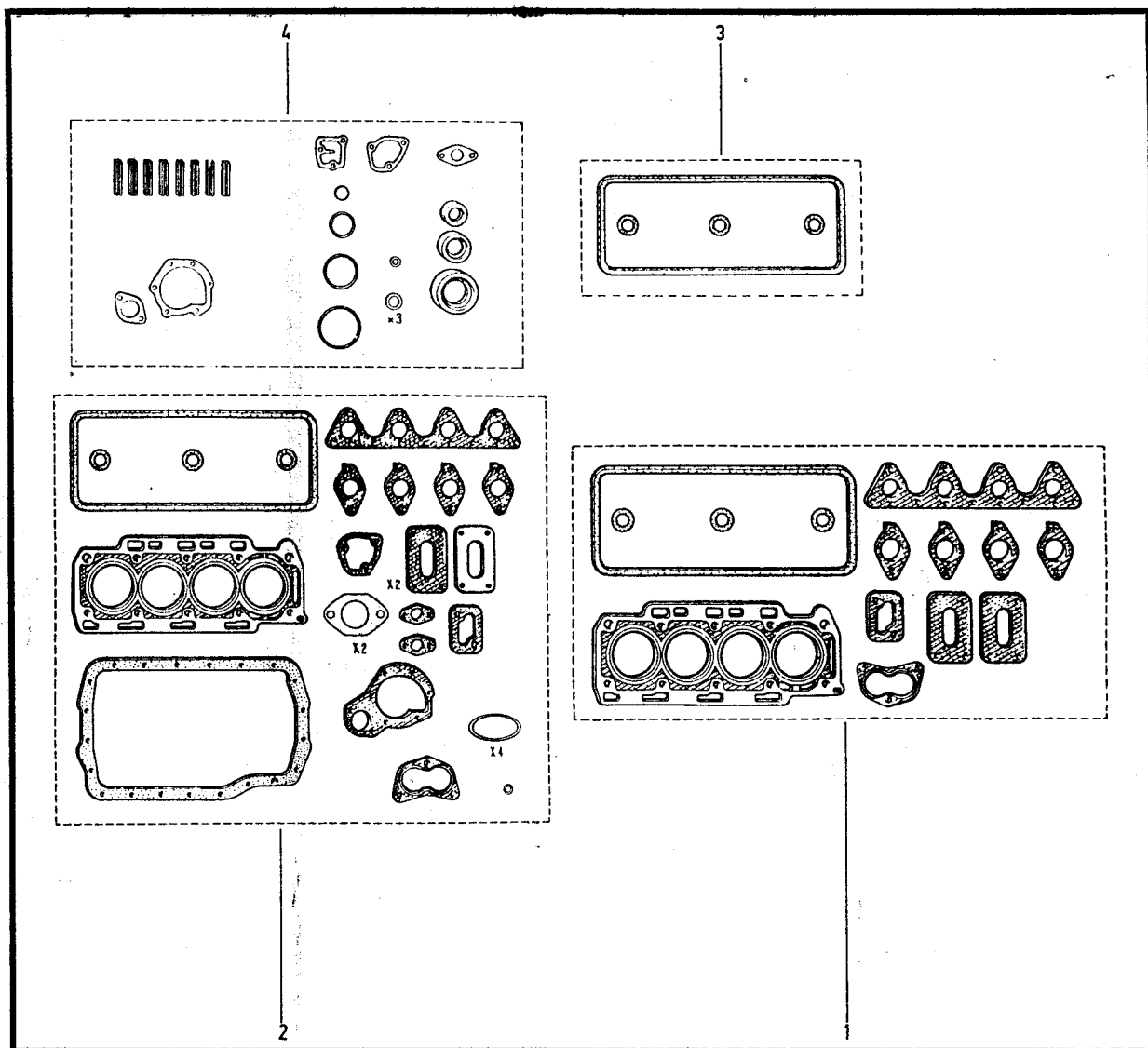
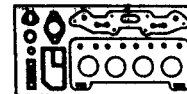

- K48S
- L48S
- L489
- K489
- L488
- K488
- K487

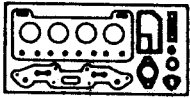

10.15.1

P.R. 1233

1- 77 02 206 407
2- 77 01 464 134
3- 77 01 464 133

Injection

10.15.1

P.R. 1233

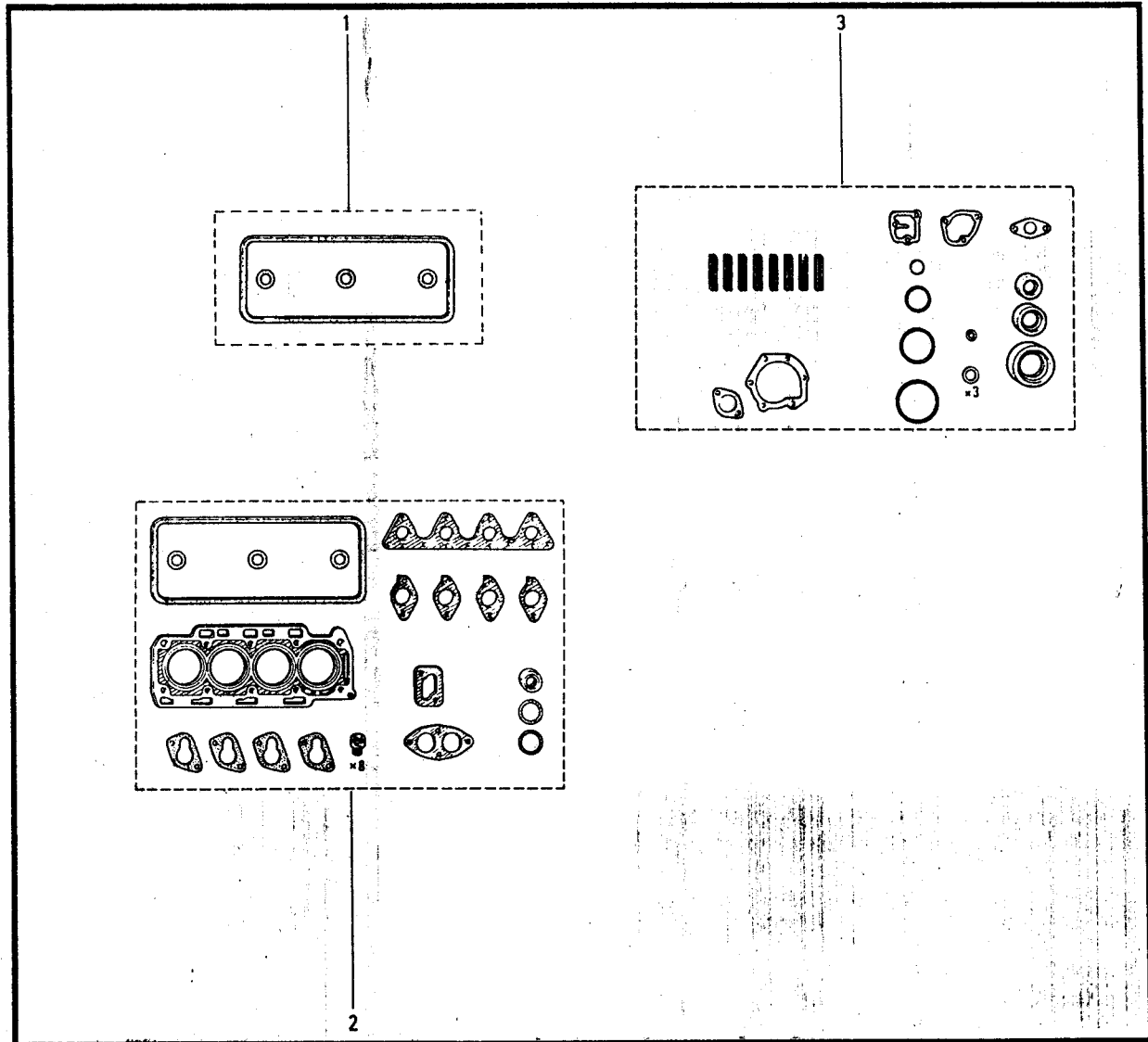
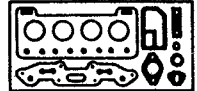

K48Y
L48Z
L48Y
K48X
L48X
K48G
L48K
L48G



10.22
P.R. 1233

1-77 02 088 794 (a)
77 02 073 281 (b)

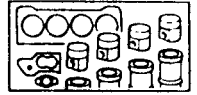

10.22
P.R. 1233

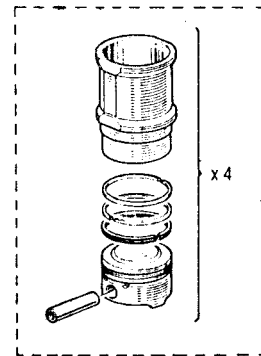

(a) / K487
/ K48S
/ L48S
/ K488
/ L488

(b) / L489
/ K489

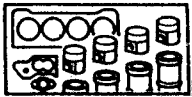

10.22.1
P.R. 1233

- 1- 77 01 464 497
- 2- 77 00 656 151
- 3- 77 00 745 933 (A=1,5)(b)
- 4- 77 00 745 934 (A=1,75)(b)
- 5- 77 00 745 932 (A=3)(b)
- 6- 77 02 073 516 (a)

Injection

10.22.1
P.R. 1233

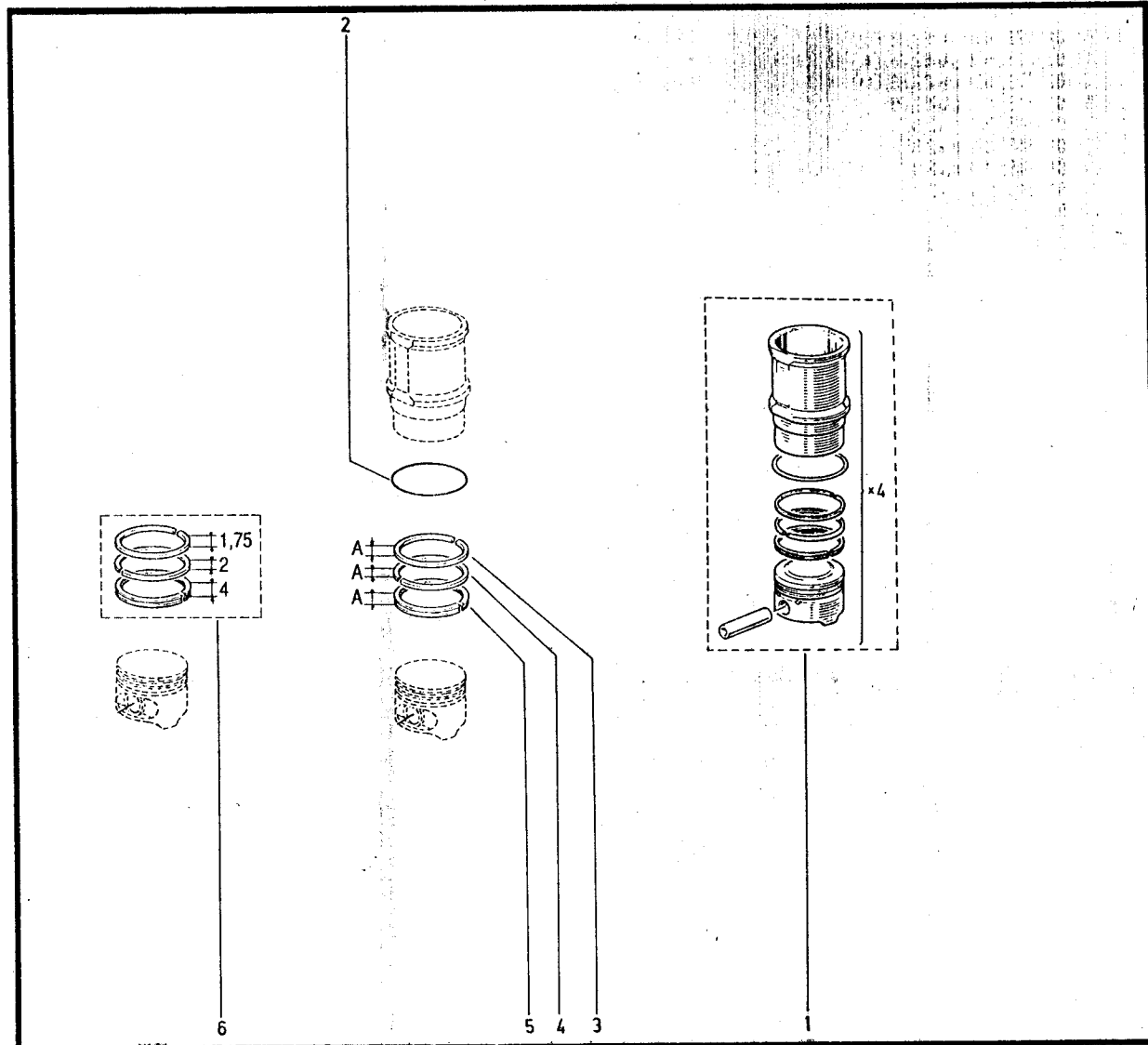
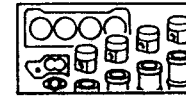

(a) /	L48Z	↔	n°	1	⇒	n°	724
	L48Z	↔	n°	725	⇒	n°
	K48G	↔	n°	1	⇒	n°
(b)	K48X	↔	n°	1	⇒	n°
	L48G	↔	n°	1	⇒	n°
	L48K	↔	n°	1	⇒	n°
	L48X	↔	n°	1	⇒	n°

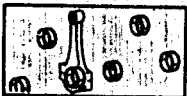

10.30
P.R. 1233

10.30
P.R. 1233

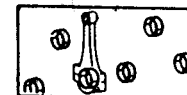

- 1- 77 02 073 499 (A=62,88) [16]
- 77 02 073 500 (A=62,88) [e]
- 77 02 073 501 (A=62,88) [11]
- 2- 77 01 348 543 (A=62,63)
- 3- 77 01 348 320 (x=2,80)
- 77 01 348 820 (x=2,85)
- 77 01 348 821 (x=2,90)
- 77 01 348 822 (x=2,95)
- 4- 77 02 088 796 (C=56,26) (a)
- 77 01 462 879 (C=56,01) (a)
- 77 02 089 202 (C=52,28) (b)
- 77 01 349 159 (C=52,03) (b)
- 77 01 460 142 (C=52,03) (b)

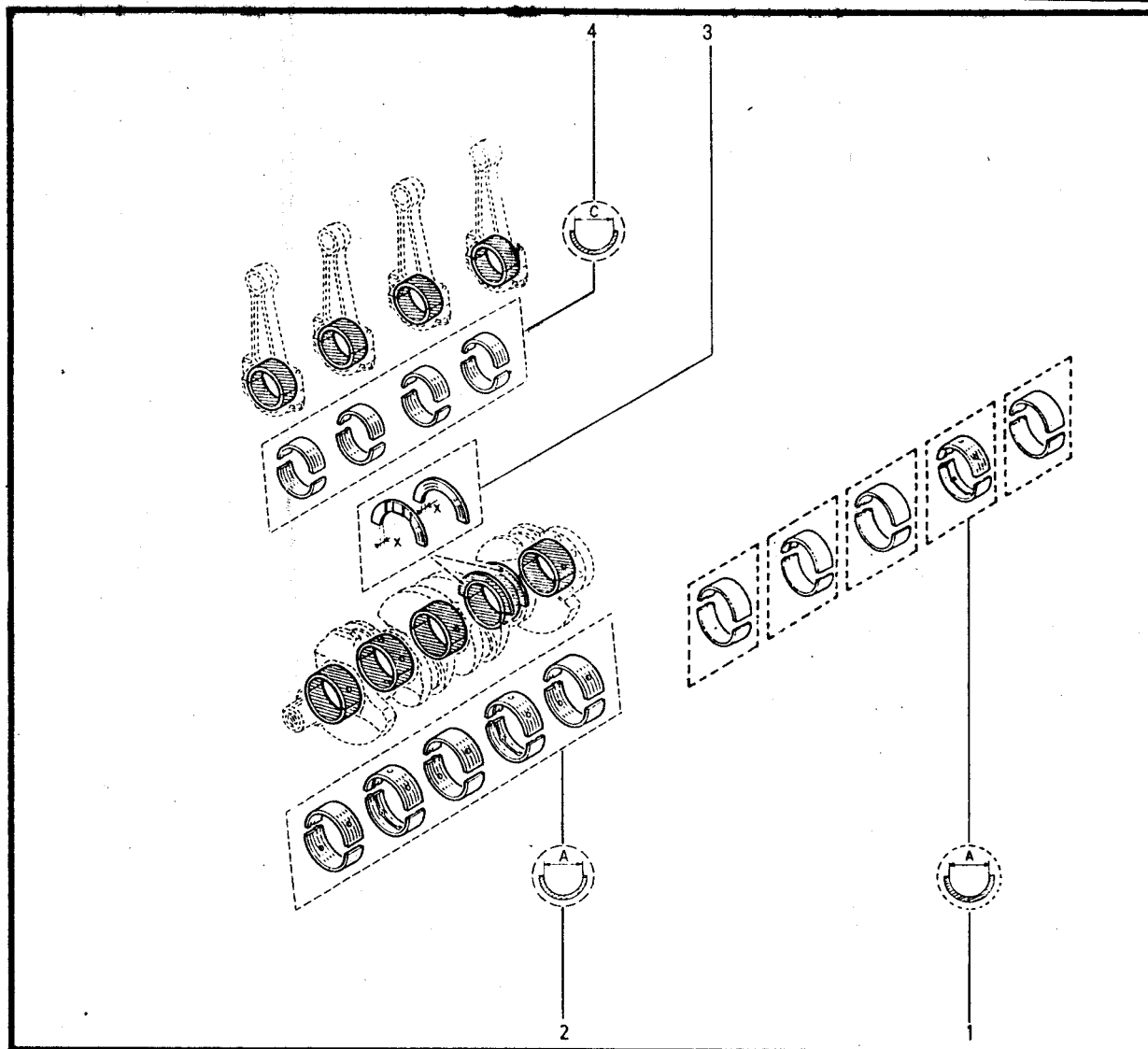

- | | |
|-----|----------------------------------|
| | K48S / K488 / K487 |
| (a) | L488 / L48S |
| | K48G / K48W / K48X / K48Y |
| | L48K / L48X / L48Y / L48W / L48G |
| (b) | L489 |
| | K489 |



10.40

P.R. 1233

10.40

P.R. 1233



- 1- 77 02 206 321 (a)
- 77 01 464 043 (b)
- 2- 77 05 010 061
- 3- 77 00 589 081
- 4- 77 03 075 138 (x=12)
- 5- 77 00 777 436
- 6- 77 03 002 037
- 7- 77 03 062 013
- 8- 77 03 075 009
- 9- 77 03 001 160
- 10- 77 03 075 206
- 11- 77 02 086 411
- 12- 77 03 075 076
- 13- 0939542
- 14- 77 03 075 025
- 15- 06 06 715 000
- 16- 77 01 349 381 (x=5,10)
- 77 01 349 382 (x=5,40)
- 17- 77 02 096 232
- 18- 95 54 895 580
- 19- 77 00 720 878
- 20- 77 02 074 052
- 21- 77 03 055 031
- 22- 79 03 057 002
- 23- 77 03 027 191
- 24- 77 02 096 229
- 25- 77 03 027 226
- 26- 77 00 656 151
- 27- 77 00 853 373
- 28- 77 00 719 274
- 29- 77 03 077 210

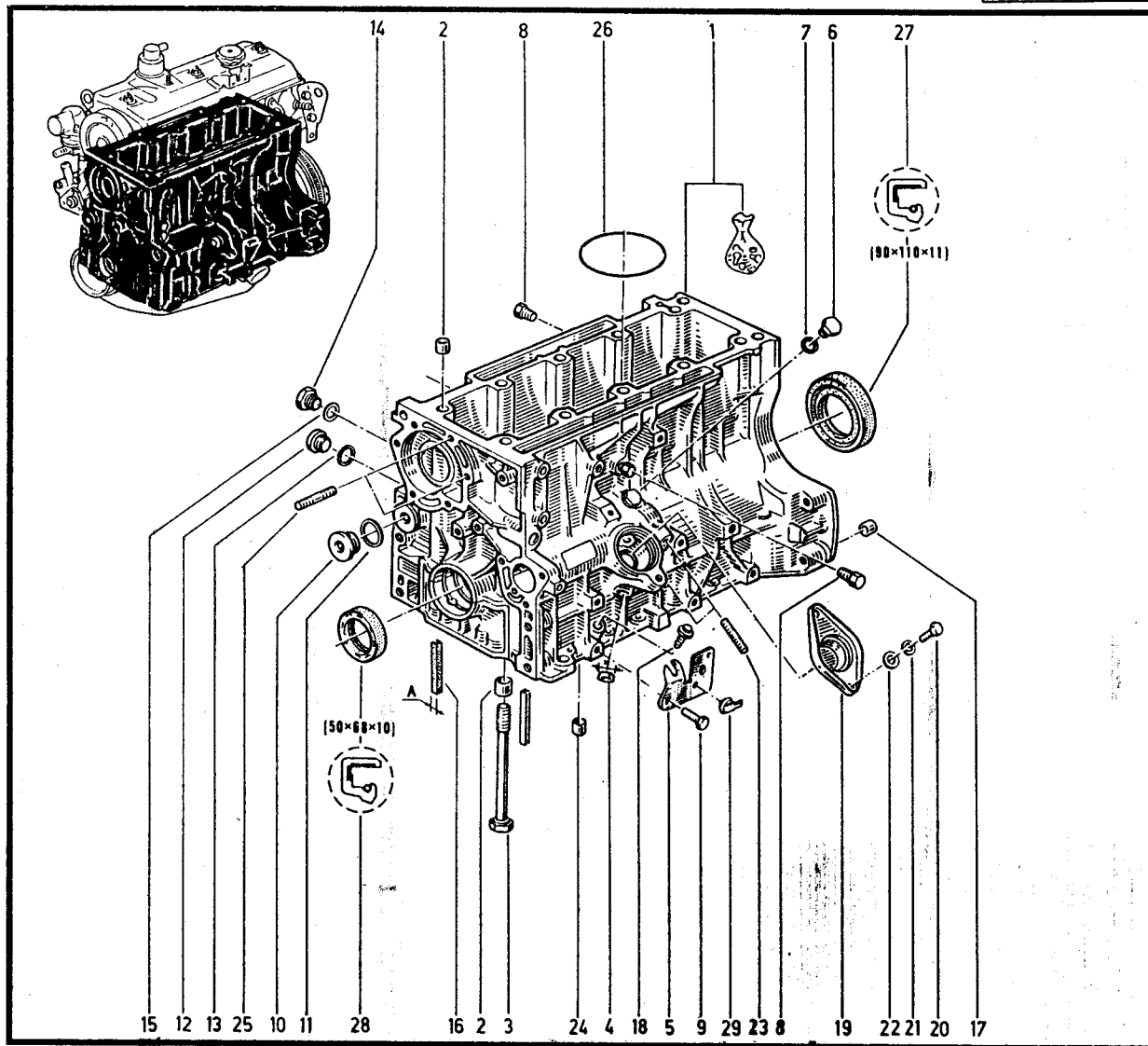

- | | |
|-----|----------------------------------|
| | K48S / K488 / K487 |
| (a) | L488 / L48S |
| | K48G / K48W / K48X / K48Y |
| | L48K / L48X / L48Y / L48W / L48G |
| (b) | L489 |
| | K489 |



10.50

P.R. 1233

10.50

P.R. 1233

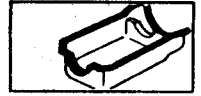

- 1 - 77 00 729 967
- 2 - 79 03 075 033
- 3 - 0.949.484
- 4 - 77 02 057 744
- 5 - 77 00 629 229
- 6 - 77 00 629 230 (16)
- 7 - 77 00 786 935 (a)
- 8 - 77 03 009 155
- 9 - 77 03 009 153
- 10 - 77 02 205 265 (b)
- 11 - 77 02 205 383 (c)

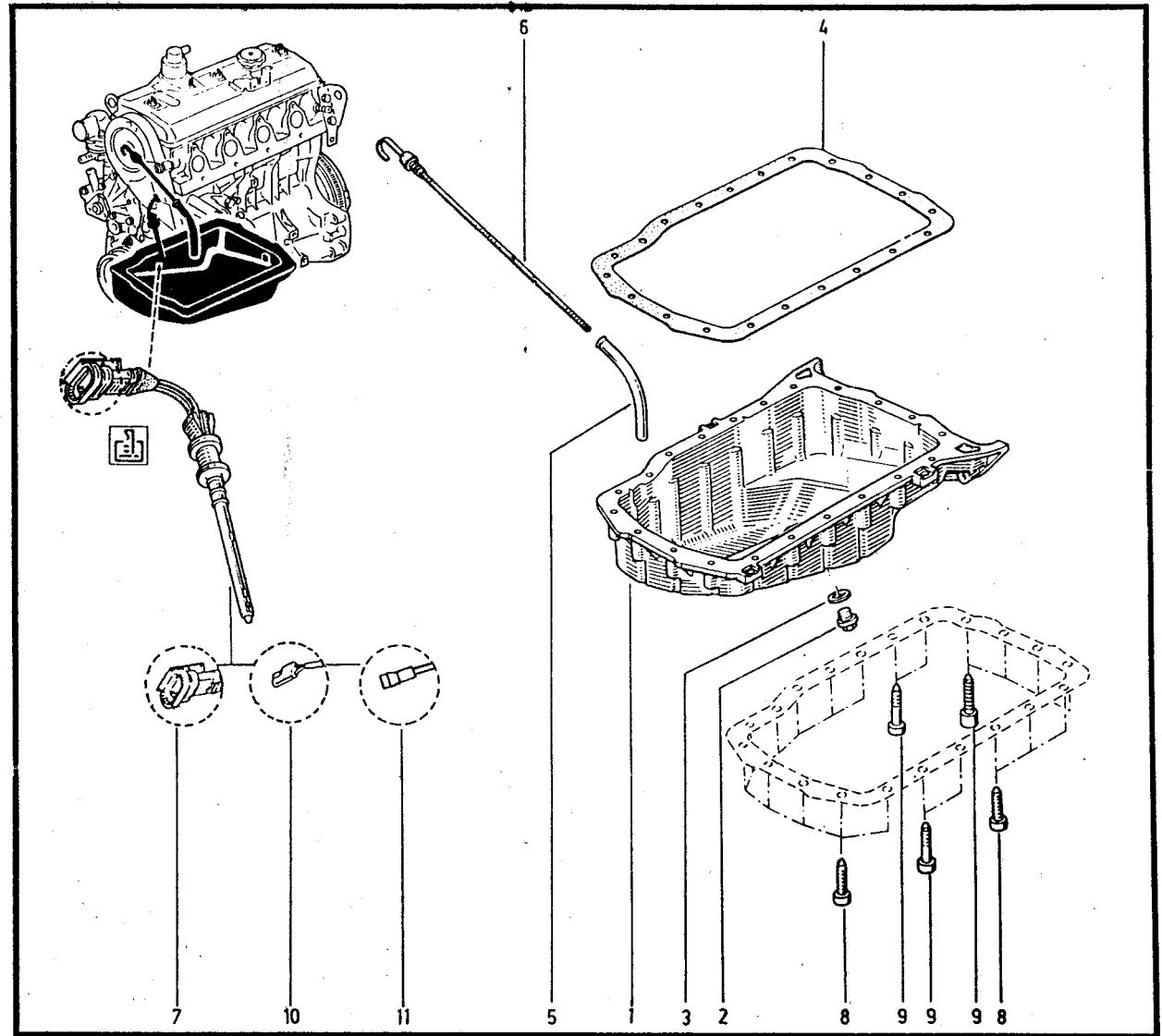

- | | | | | | | | |
|-----|------|---|------|-------|----|-------|-------|
| (a) | L48S | ↔ | n° | 1 | ↔ | n° | 01517 |
| (b) | L48S | ↔ | n° | 01518 | ↔ | n° | |
| (c) | L489 | ↔ | 9/91 | ↔ | n° | | |
| | L48S | ↔ | 9/91 | ↔ | n° | | |
| | K489 | ↔ | 9/91 | ↔ | n° | | |
| | K48S | ↔ | 9/91 | ↔ | n° | | |
| | K487 | ↔ | n° | 1 | ↔ | n° | |



10.60

P.R. 1233

10.60

P.R. 1233



- 1- 77 02 086 866 (a)
- 77 02 057 942 (b)
- 2- 77 02 087 207
- 3- 77 02 056 384
- 4- 77 00 647 358
- 5- 77 03 070 009
- 6- 77 00 708 304
- 7- 77 00 850 621
- 8- 77 03 067 080
- 9- 77 00 853 774 (a)
- 77 00 690 984 (b)
- 10- 77 00 670 967
- 11- 77 01 461 155 (b)
- 77 01 461 649 (a)
- 12- 77 03 053 259
- 13- 77 02 073 516
- 14- 77 00 655 434
- 15- 77 00 525 922
- 16- 77 02 206 545

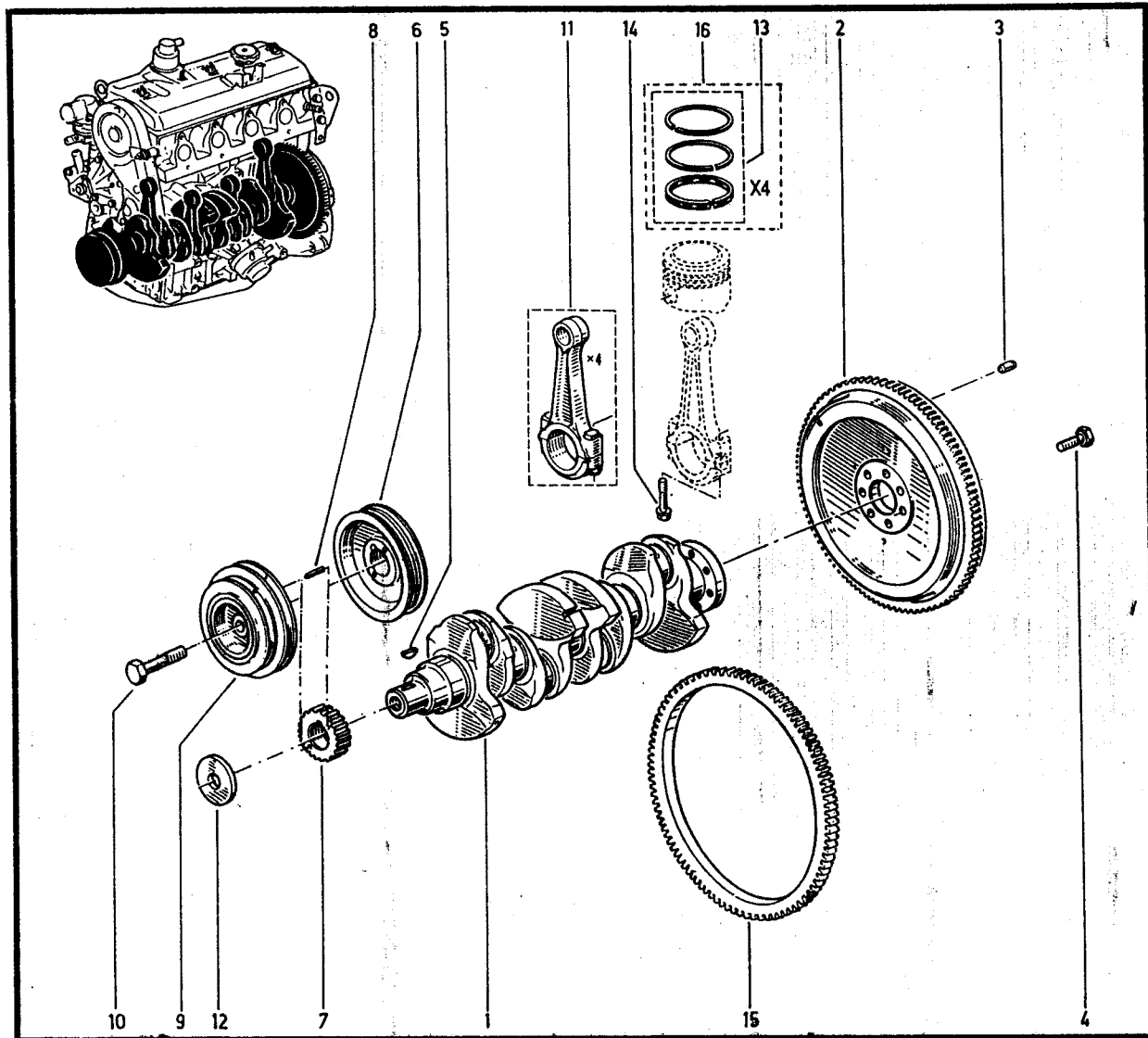

	K487
	K48S
(a)	L48S
	K488
	L488
(b)	L489
	K489



10.60.1

P.R. 1233

Injection

10.60.1

P.R. 1233

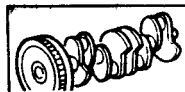

- 1- 77 02 086 866
- 2- 79 46 002 384
- 3- 77 02 056 384
- 4- 77 00 647 358
- 5- 77 03 070 009
- 6- 77 00 708 304
- 7- 77 00 850 621
- 8- 77 03 067 080
- 9- 77 00 853 774
- 10- 77 00 670 967
- 11- 77 01 461 649
- 12- 77 03 053 259
- 13- 77 00 525 922
- 14- 77 00 655 434

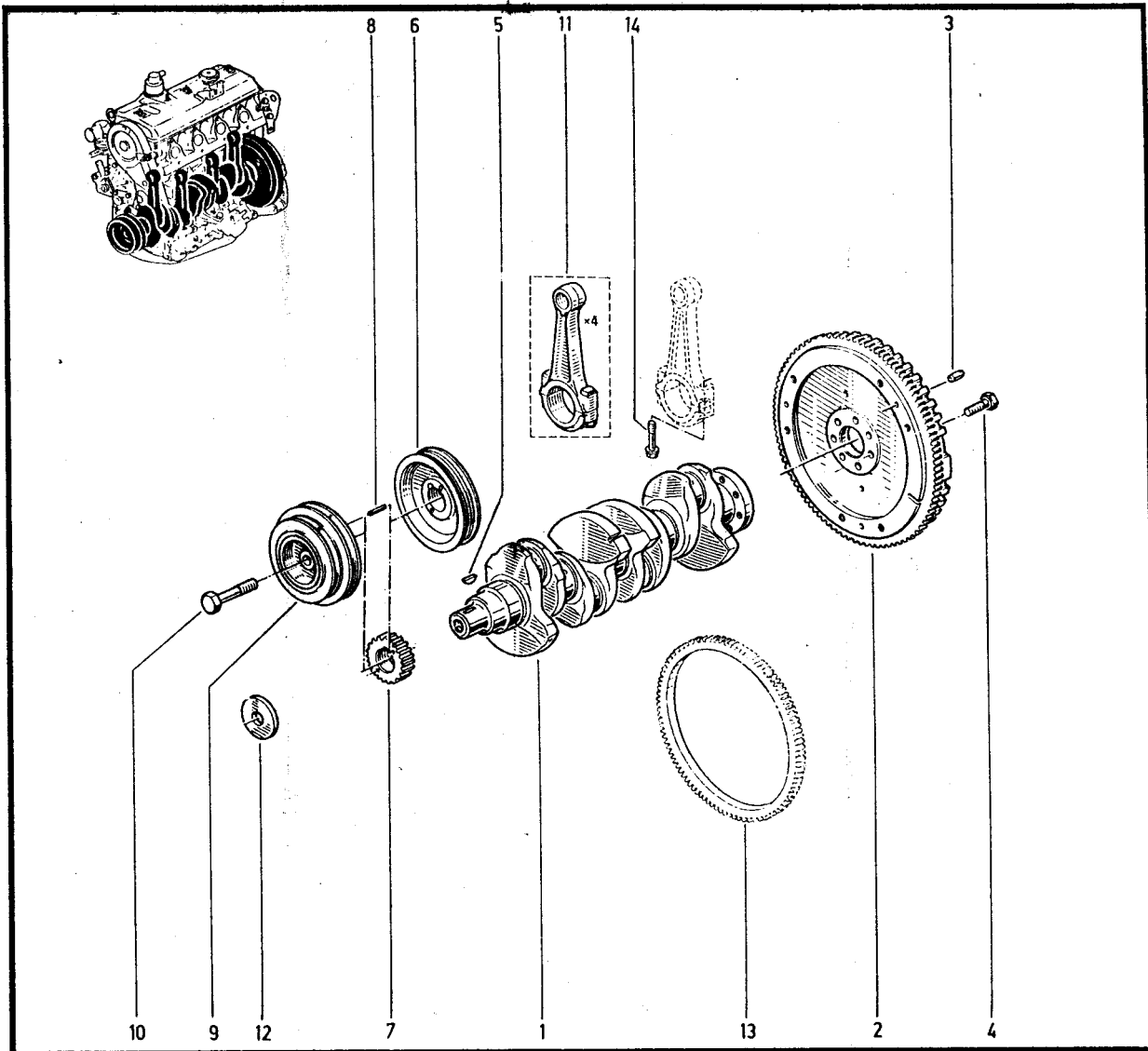

- K48Y
- L48Z
- L48Y
- K48X
- L48X
- K48G
- L48K
- L48G



10.65

P.R. 1233

10.65

P.R. 1233



- 1-77 01 460 152
- 2-77 00 713 012
- 3-77 03 001 160
- 4-77 03 053 037
- 77 03 053 291
- 5-77 03 070 007
- 6-77 00 655 189
- 7-77 03 001 142
- 8-77 03 055 031
- 9-79 03 053 157
- 10-77 00 853 000
- 11-77 00 719 273
- 12-77 00 850 623
- 13-77 03 101 069
- 14-77 03 053 189

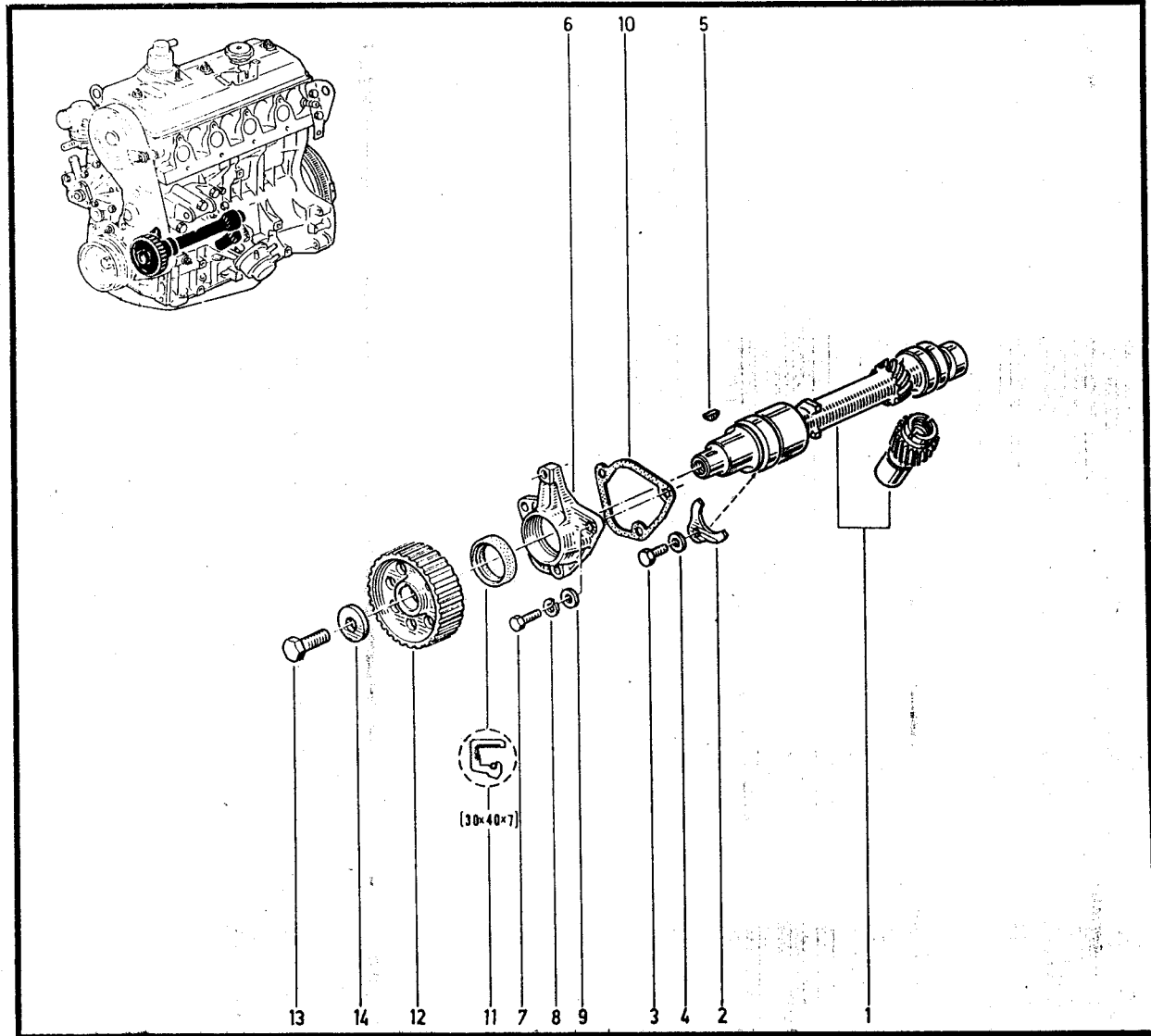

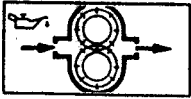

10.70
P.R. 1233

- 1-77 01 465 119
- 2-77 00 724 211
- 3-77 03 066 231
- 4-77 00 771 825 (a)(c)(d)
- 5-77 03 062 043
- 6-77 00 655 787 (b)

10.70
P.R. 1233

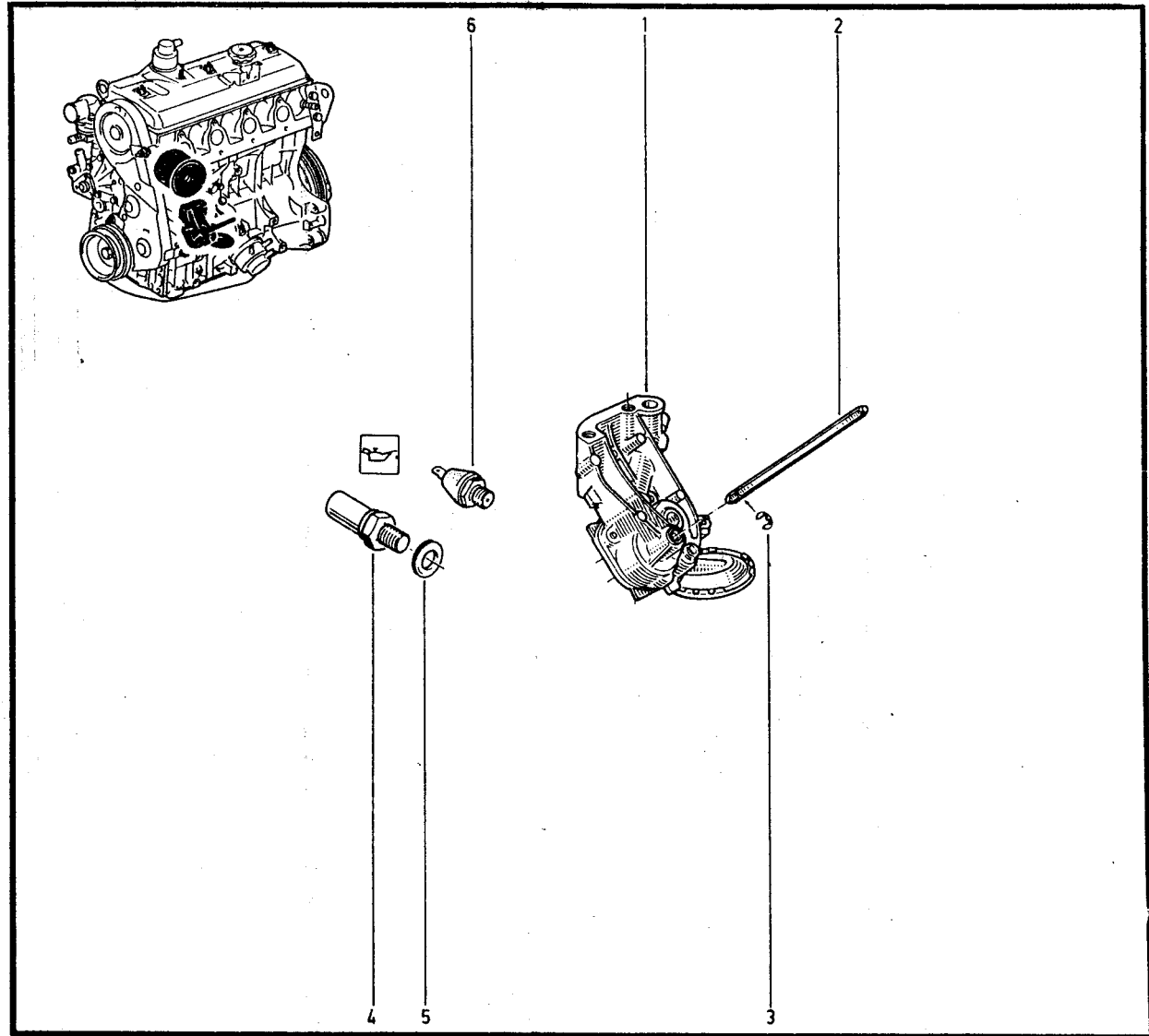
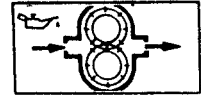

(a)	L48S	n°	1	→	n°01517
(b)	L48S	n°	01518	→	n°.....
(d)	TXI				

(c)	K487	n°	1	→	n°.....
	L48S	4.9.93	→	n°.....	
	L488	4.9.93	→	n°.....	
	K48S	4.9.93	→	n°.....	
	K488	4.9.93	→	n°.....	



10.78

P.R. 1233

1 - 77 02 073 777
2 - 77 00 727 684

10.78

P.R. 1233

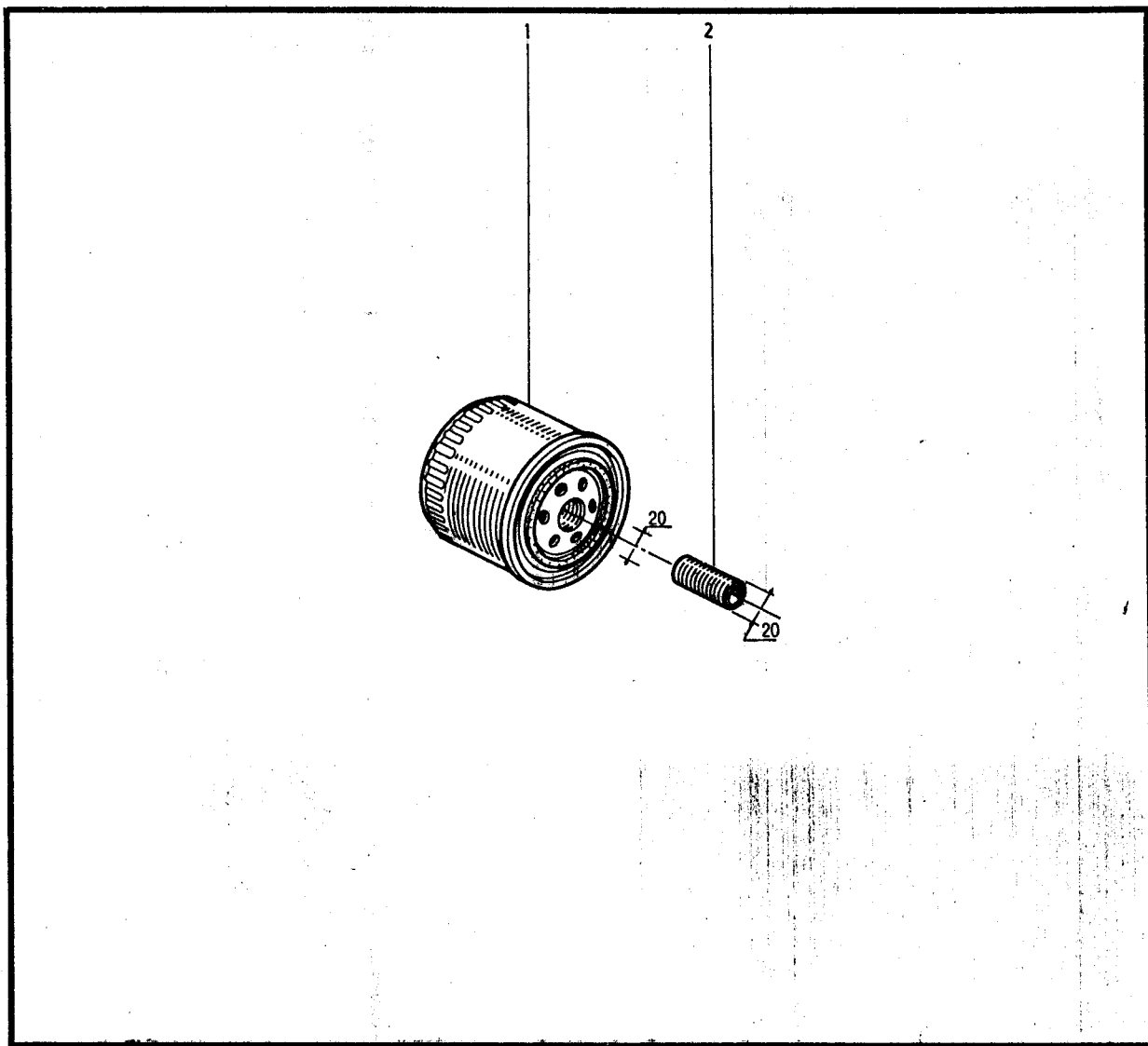

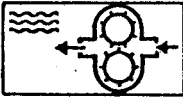

11.01

P.R. 1233

11.01

P.R. 1233

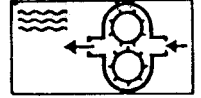

- 1- 77 02 206 010
- 2- 77 01 466 351
- 3- 79 03 053 157
- 4- 77 03 055 031
- 5- 79 03 032 012
- 6- 77 03 001 607
- 7- 77 03 001 146
- 8- 77 04 000 797
- 9- 77 03 001 848
- 10- 77 03 055 011
- 11- 77 00 730 064
- 12- 77 02 086 699 ←
- 13- 77 04 000 276
- 14- 77 00 723 640
- 15- 77 03 062 001
- 16- 77 03 001 162
- 17- 77 03 053 037
- 18- 77 00 771 821 [13]
- 19- 77 02 056 723
- 20- 77 00 786 460 [5]
- 21- 77 00 735 847

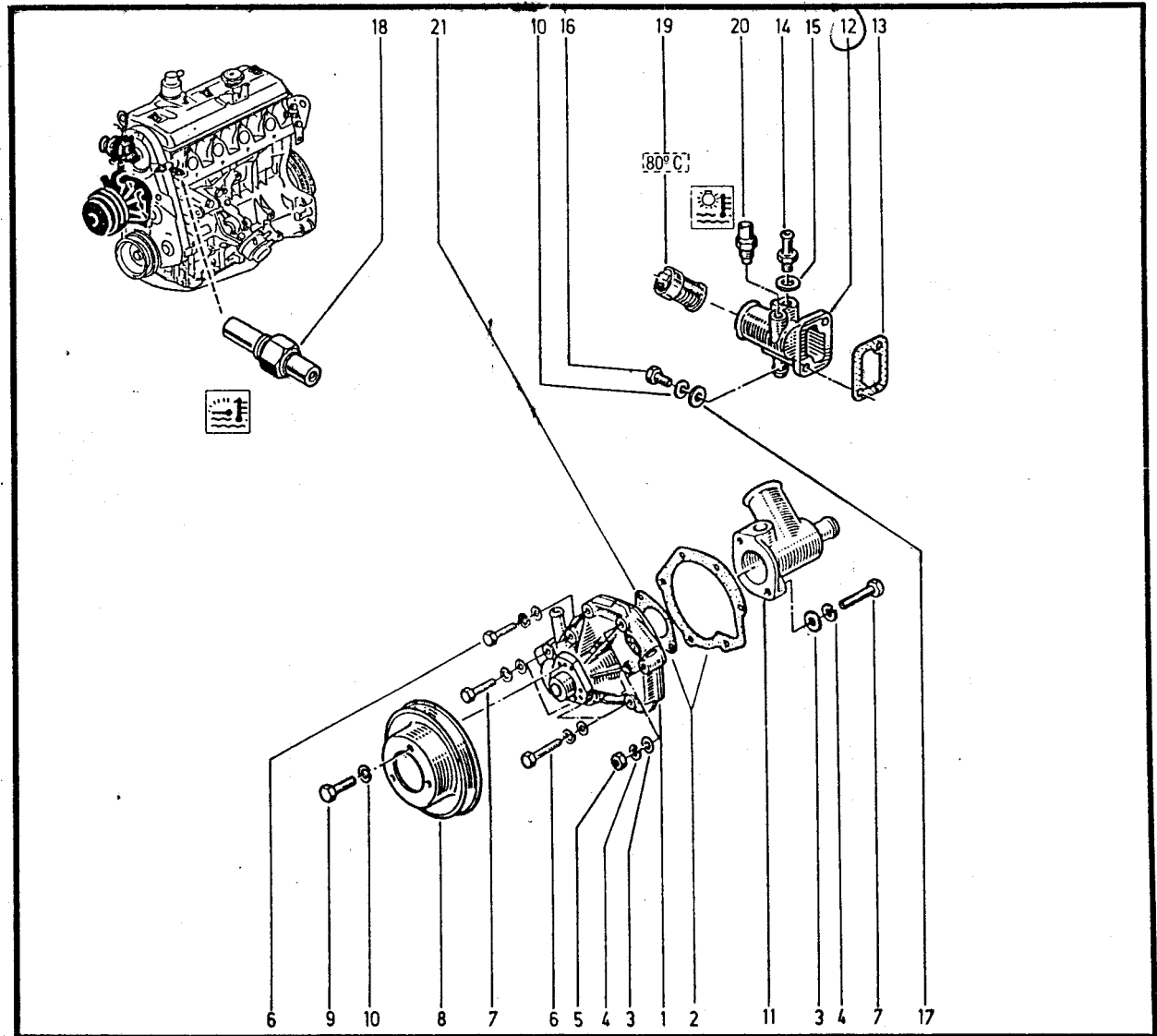

K487
K48S
L48S
L489
K489
L488
K488

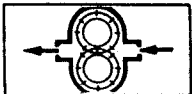

11.01.1
P.R. 1233

Injection

11.01.1
P.R. 1233

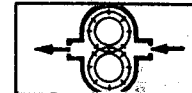

- 1- 77 01 465 513 †
- 77 02 217 532
- 2- 77 01 466 351
- 3- 77 03 053 036
- 4- 77 03 055 031
- 5- 79 03 032 012
- 6- 77 03 001 607
- 7- 50 03 001 123
- 8- 77 00 729 156
- 9- 77 03 001 158
- 10- 77 03 055 011
- 11- 77 00 730 064
- 12- 77 00 727 253 =
- 13- 77 00 853 897
- 14- 77 00 723 640
- 15- 77 03 062 001
- 16- 77 03 001 162
- 17- 77 03 053 037
- 18- 77 00 771 821 (C)
- 19- 77 00 727 190
- 20- 77 00 786 460 (C)
- 21- 77 03 062 068
- 22- 77 00 730 022

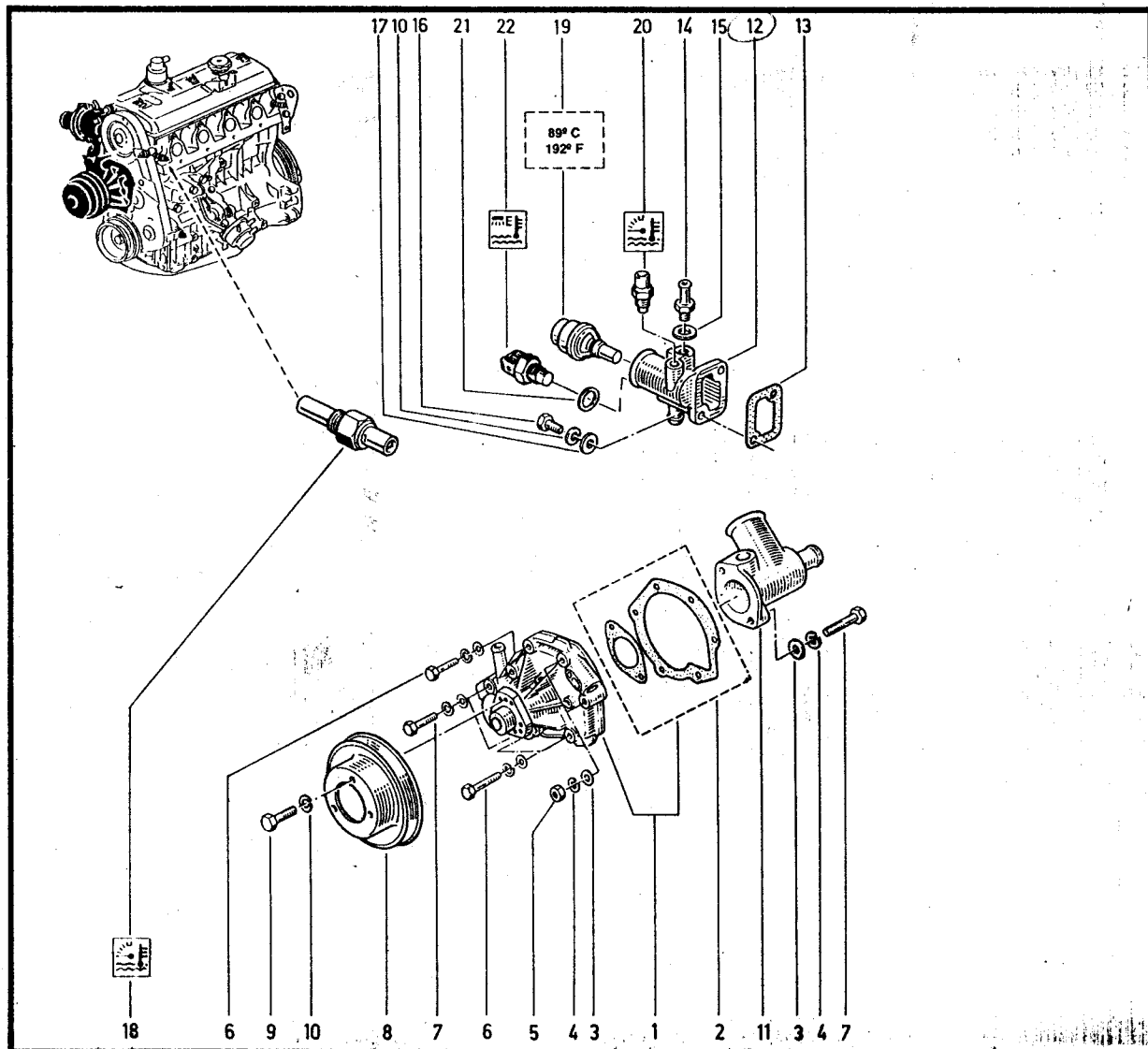

- K48Y
- L48Z
- L48Y
- K48X
- L48X
- K48G
- L48K
- L48G



11.20

P.R. 1233

- 1-77 02 206 084
- 2-77 01 462 486 (X=13,35)
- 3-77 00 737 124
- 4-77 03 075 144
- 5-77 03 075 038
- 6-77 03 075 032
- 7-77 05 010 000
- 8-77 00 854 842
- 9-07 06 329 400
- 10-77 03 027 076
- 11-77 00 854 710
- 12-77 00 737 124
- 13-77 01 462 486 (X=13,35)

11.20

P.R. 1233

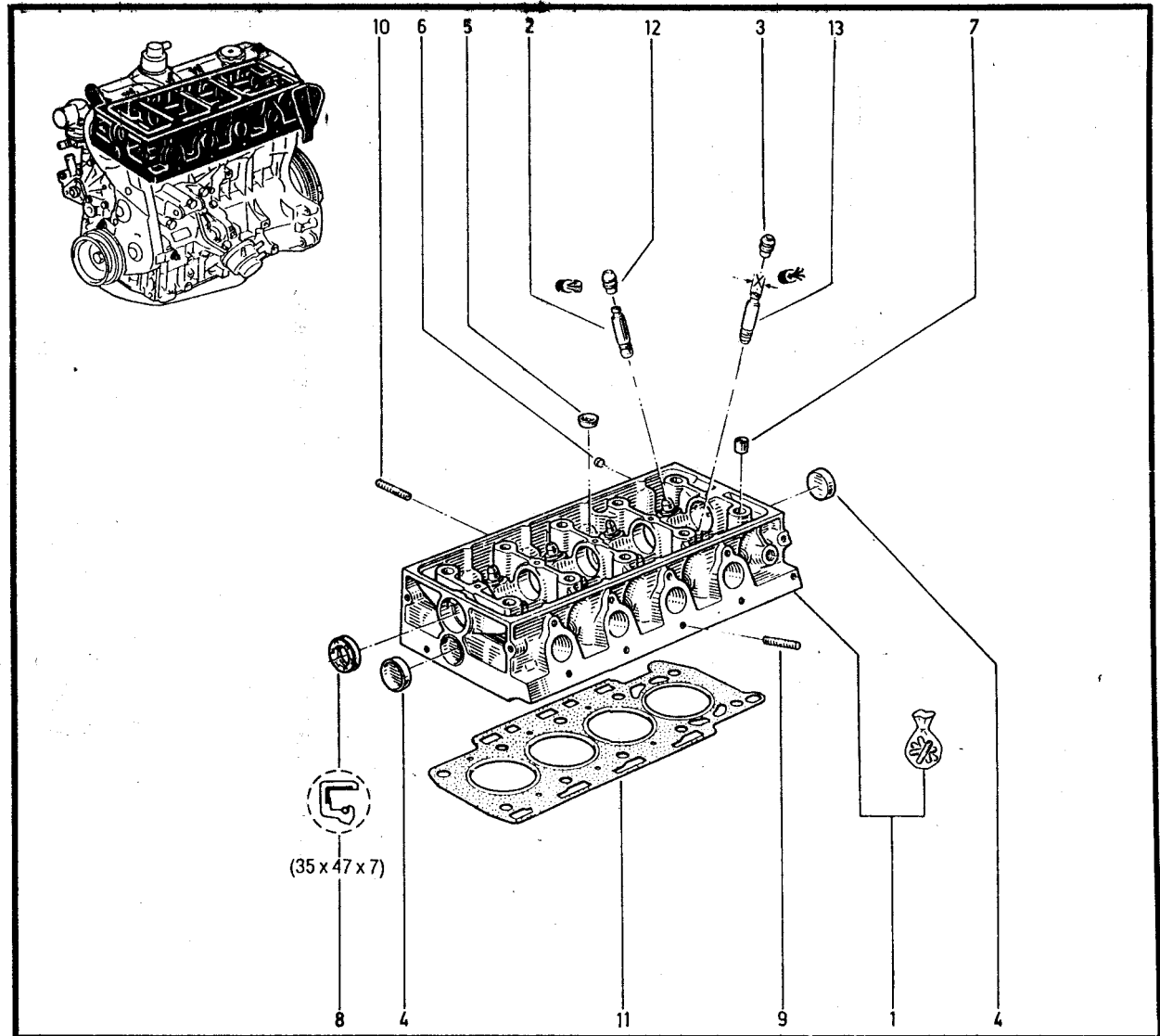
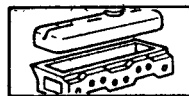

- K487
- K48S
- L48S
- L489
- K489
- L488
- K488

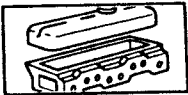

11.20.1
P.R. 1233

Injection

11.20.1
P.R. 1233

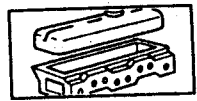

- 1- 77 01 464 790
- 2- 77 01 462 486
- 3- 77 00 737 124
- 4- 77 03 075 144
- 5- 77 03 075 038
- 6- 77 03 075 032
- 7- 77 05 010 000
- 8- 77 00 854 842
- 9- 07 06 329 400
- 10- 77 03 027 076
- 11- 77 00 854 710

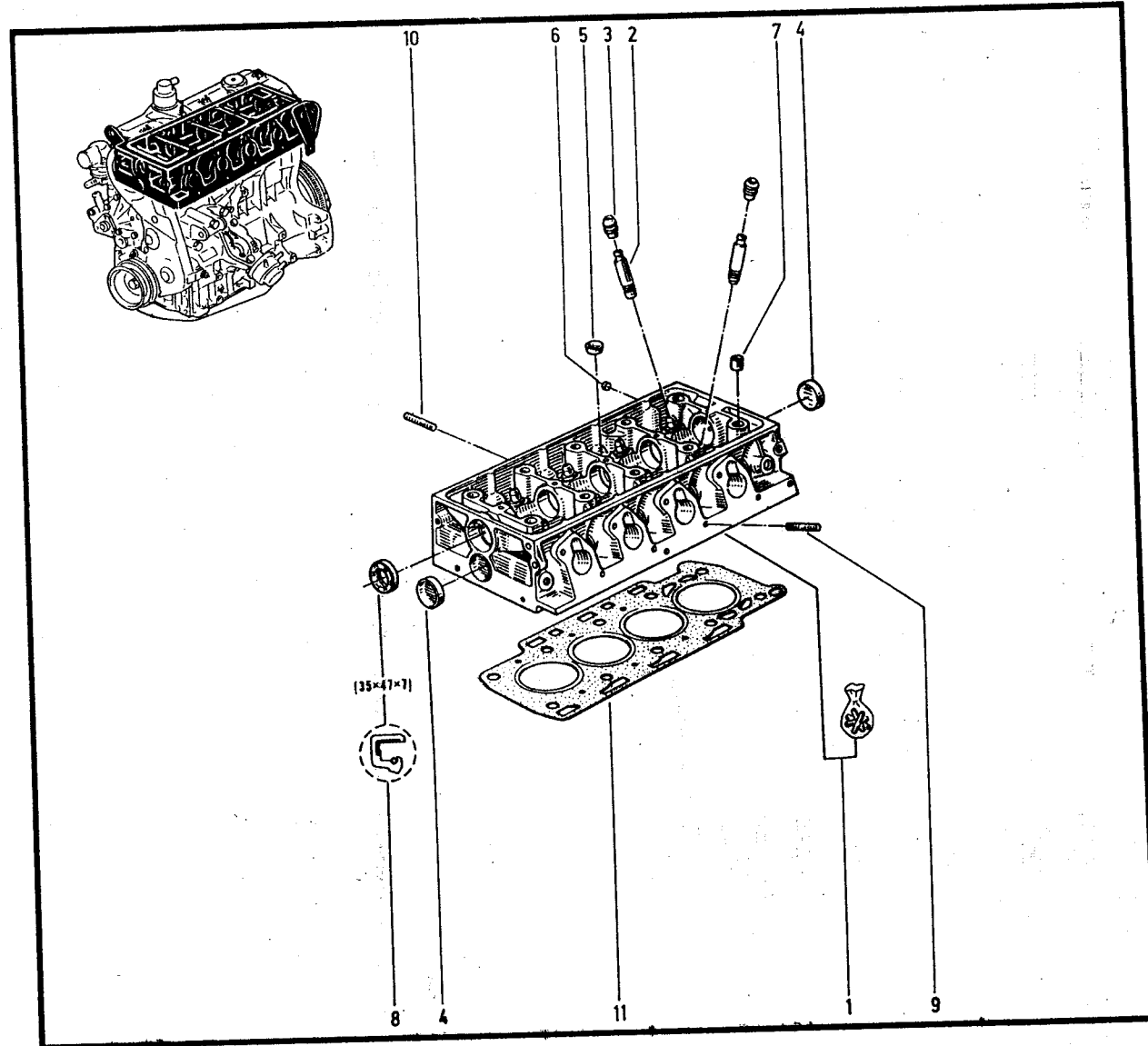

- K48Y
- L48Z
- L48Y
- K48X
- L48X
- K48G
- L48K
- L48G



11.30

P.R. 1233

- 1- 77 00 668 283 (a)
- 77 02 087 144 (b)
- 2- 77 00 634 996
- 3- 77 03 027 113
- 4- 77 05 001 211
- 5- 77 00 616 373
- 6- 79 03 053 038
- 7- 79 03 056 042
- 8- 79 03 032 012
- 9- 77 03 027 228
- 10- 77 02 057 296
- 11- 77 03 001 142
- 12- 77 02 086 194
- 13- 77 02 206 407
- 14- 77 03 033 003
- 15- 77 02 086 760
- 16- 77 02 087 438
- 17- 77 00 680 354

11.30

P.R. 1233

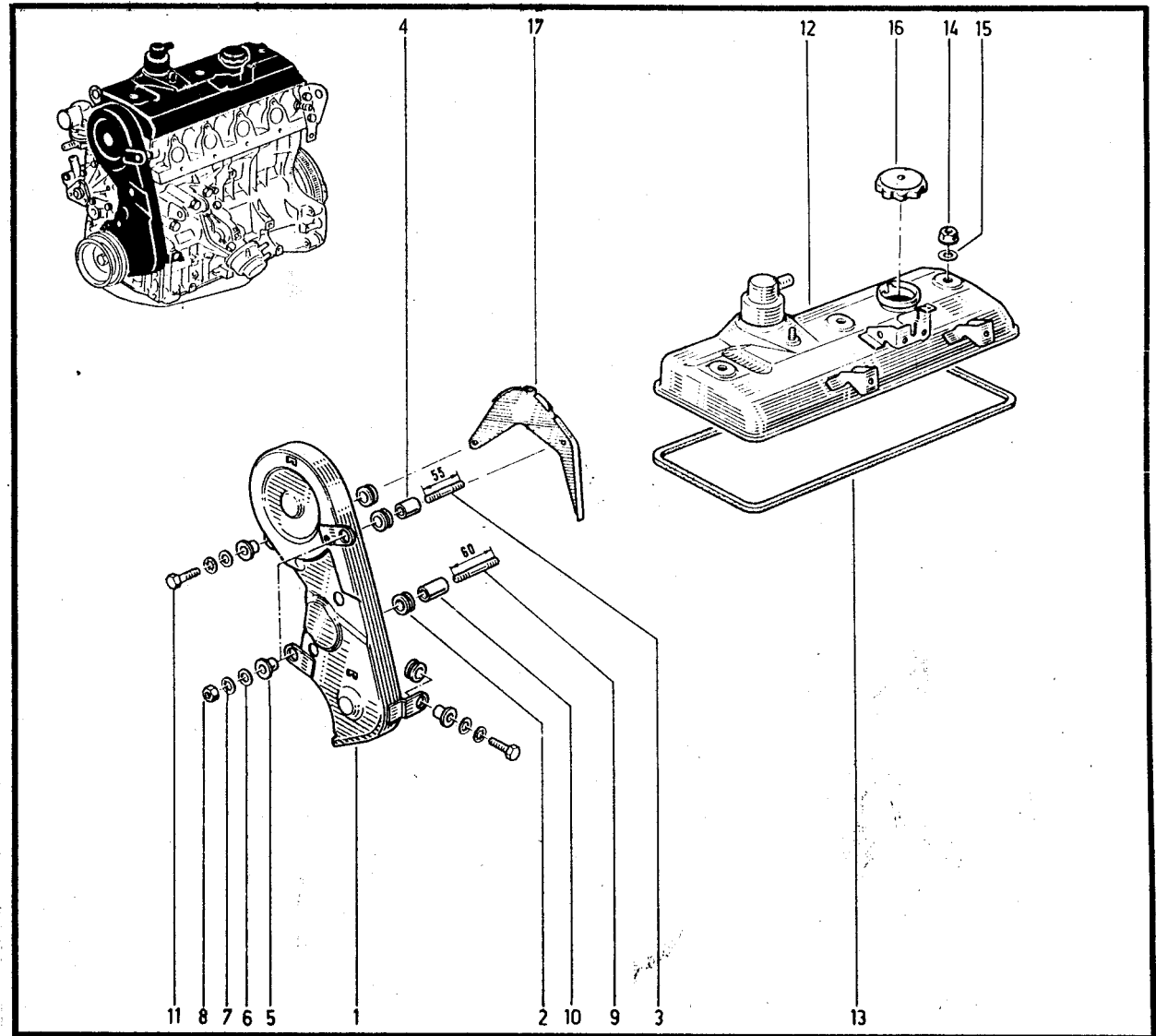
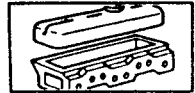

K487
K48S
L48S
(a) K488
L488

(b) / L489
K489



11.30.1
P.R. 1233

Injection

11.30.1
P.R. 1233



- 1-77 00 727 193
- 2-77 00 634 996
- 3-77 03 027 113
- 4-77 00 727 251
- 5-77 05 001 211
- 6-77 00 616 373
- 7-77 03 053 036
- 8-77 00 731 871
- 9-79 03 032 012
- 10-77 03 027 228
- 11-77 05 001 210
- 12-77 03 001 142
- 13-77 00 861 034
- 14-77 02 206 407
- 15-77 03 033 003
- 16-77 02 086 760
- 17-77 00 741 840
- 18-77 05 001 368
- 19-77 03 001 138

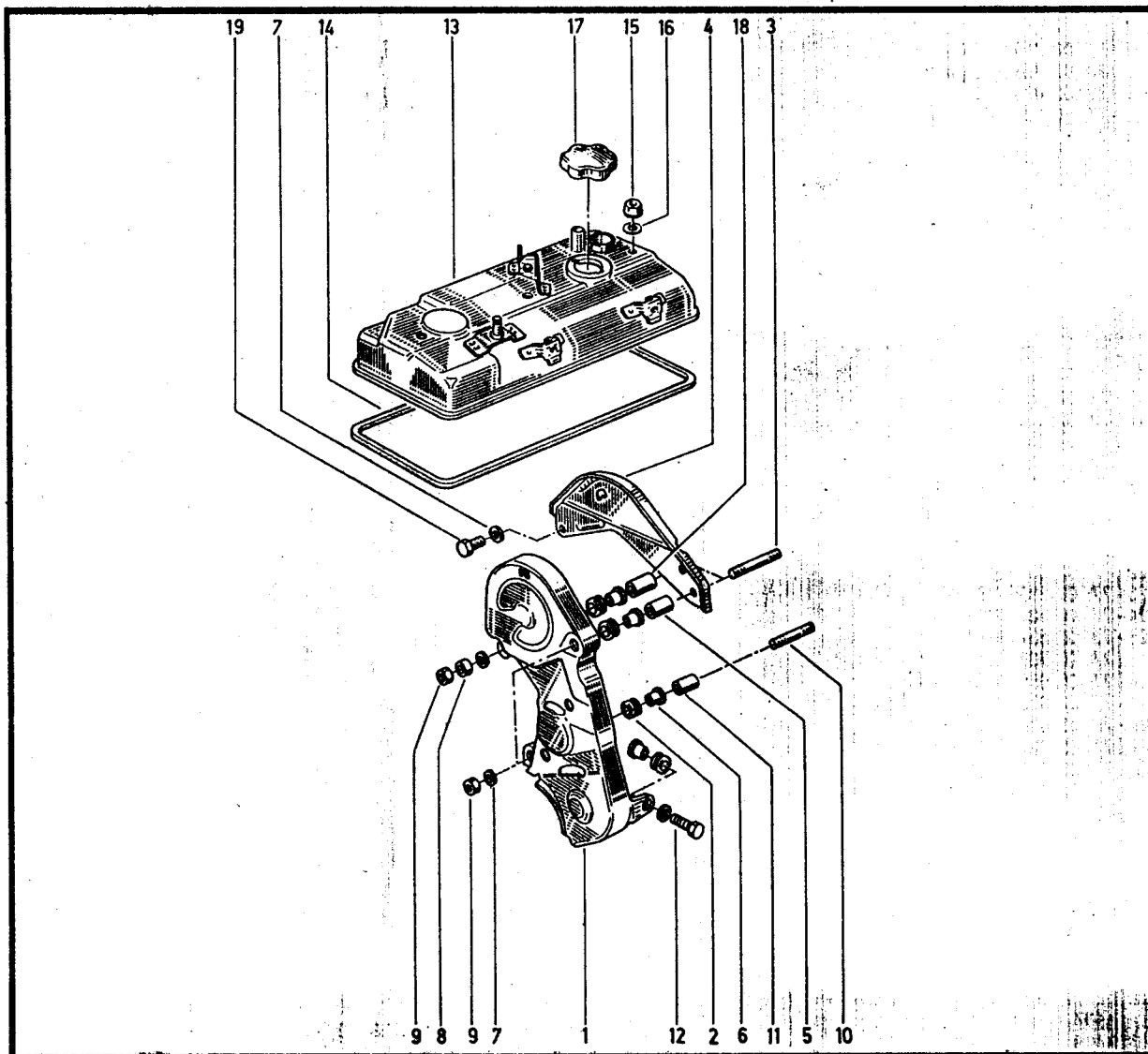

- K48Y
- L48Z
- L48Y
- K48X
- L48X
- K48G
- L48K
- L48G



11.40
P.R. 1233

11.40
P.R. 1233



- 1-77 00 710 310 (b)
- 77 00 735 509 (a)
- 2-77 03 070 007
- 3-77 00 587 893
- 4-77 03 001 140
- 5-79 03 056 012
- 6-77 00 713 992
- 7-77 03 101 091
- 8-77 03 053 345
- 9-77 00 718 836 (a)
- 77 00 717 284 (b)
- 10-77 05 015 125
- 11-77 00 653 759
- 12-77 03 027 094
- 13-77 00 692 315
- 14-77 03 001 498
- 15-77 03 053 292
- 16-79 03 032 018
- 17-77 02 056 989
- 77 02 086 442
- 18-77 03 053 700
- 19-79 10 019 274
- 20-77 00 268 948
- 21-77 01 349 125
- 22-77 02 057 001
- 23-77 00 588 718
- 24-77 00 588 717
- 25-77 00 637 916 (M)
- 77 00 730 830 (M)
- 26-77 00 650 095
- 27-77 03 075 053
- 28-77 03 075 039
- 29-77 03 067 250
- 30-77 05 015 003
- 31-79 10 015 788 (M)
- 79 46 006 314 (M)
- 32-77 00 728 983
- 33-77 03 032 063
- 34-77 00 731 871
- 35-77 00 671 408
- 36-79 03 053 184
- 37-77 03 027 191
- 38-79 03 057 005

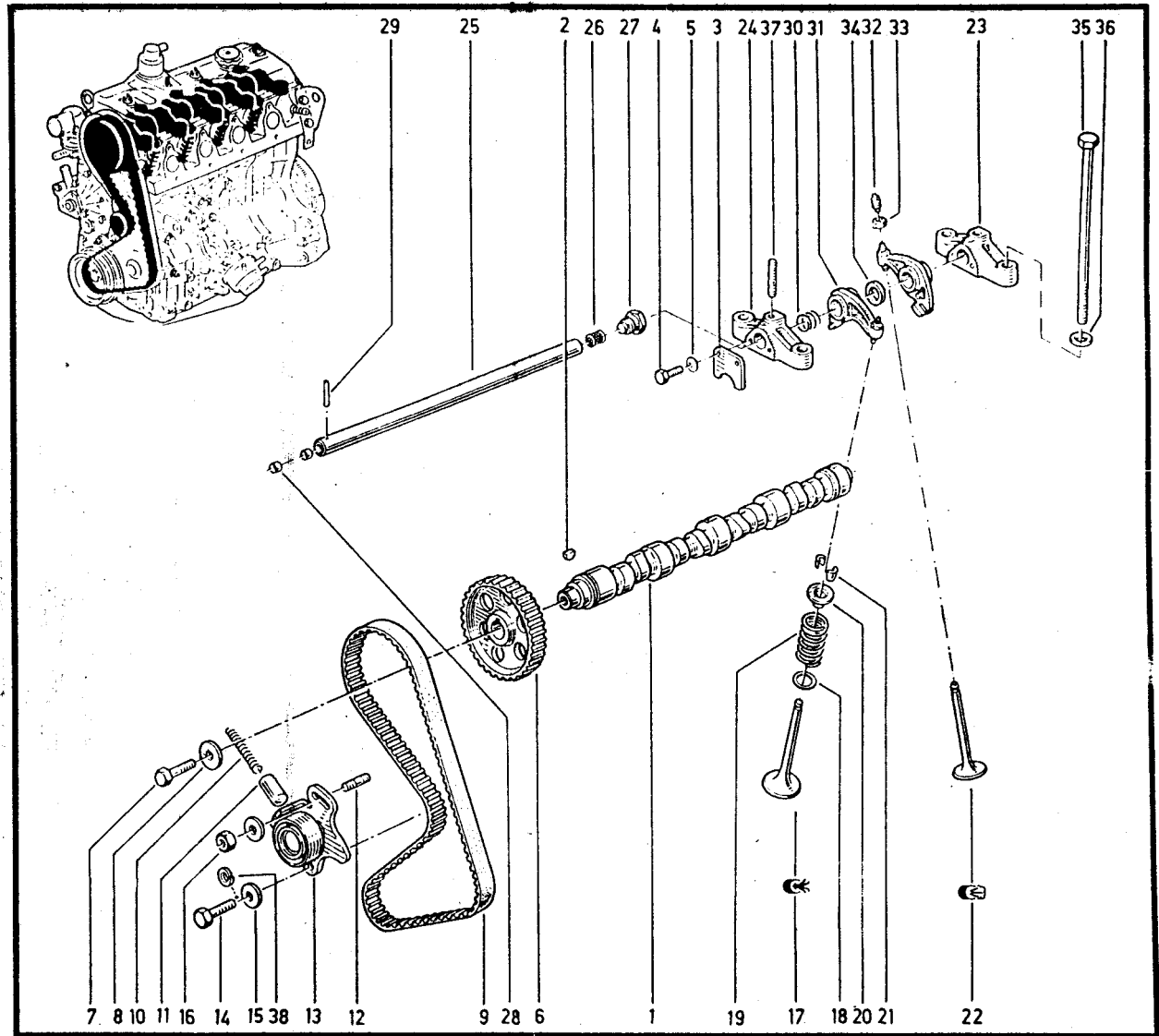

K487
 K48S
 (a) L48S
 K488
 L488
 (b) L489
 K489



11.40.1

P.R. 1233

11.40.1

P.R. 1233



Injection

- 1- 77 00 735 509
- 2- 77 03 070 007
- 3- 77 00 587 893
- 4- 77 03 001 140
- 5- 79 03 056 012
- 6- 77 00 713 992
- 7- 79 03 053 184
- 8- 77 03 027 191
- 9- 77 00 718 836
- 10- 79 03 057 005
- 11- 77 00 671 408
- 12- 77 03 027 094
- 13- 77 00 745 215
- 14- 77 03 001 498
- 15- 77 03 053 292
- 16- 79 03 032 018
- 17- 77 02 056 989
- 77 02 086 442
- 18- 77 03 053 700
- 19- 79 10 019 274
- 20- 77 00 268 948
- 21- 77 01 349 125
- 22- 77 02 057 001
- 23- 77 00 588 718
- 24- 77 00 588 717
- 25- 77 00 730 830
- 26- 77 00 650 095
- 27- 77 03 075 053
- 28- 77 03 075 039
- 29- 77 03 067 250
- 30- 77 05 015 003
- 31- 79 46 006 314
- 32- 77 00 728 983
- 33- 77 03 033 042
- 34- 77 00 731 871

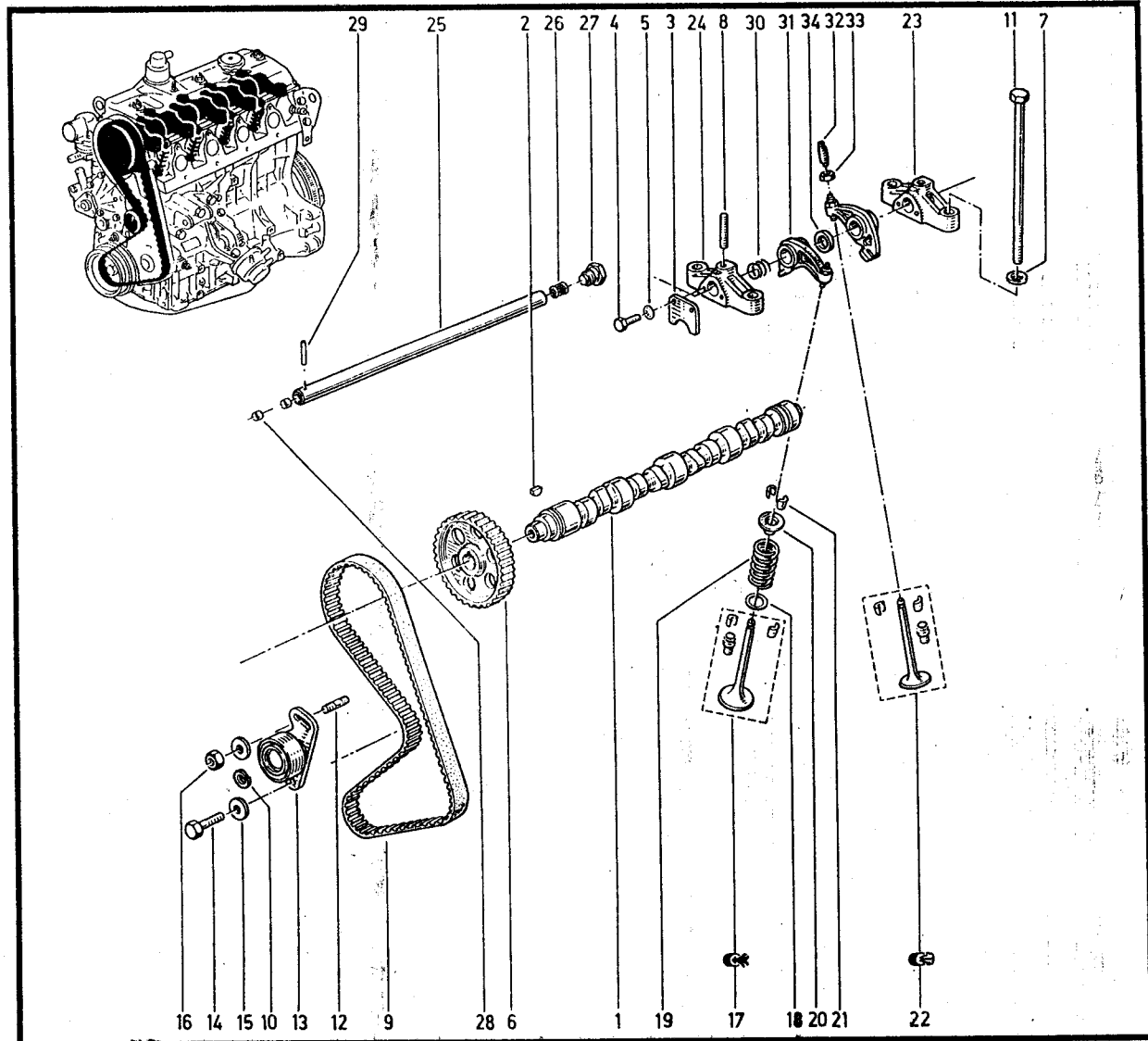

K48Y 092/090
 L48Z 091/095
 L48Y 091



11.40.2

P.R. 1233

Injection

11.40.2

P.R. 1233



- 1- 77 00 734 403
- 2- 77 03 070 007
- 3- 77 00 587 893
- 4- 77 03 001 140
- 5- 79 03 056 012
- 6- 77 00 713 992
- 7- 77 00 671 408
- 8- 79 03 053 184
- 9- 77 00 718 836
- 10- 77 03 027 191
- 11- 79 03 057 005
- 12- 77 03 027 094
- 13- 77 00 745 215
- 14- 77 03 001 498
- 15- 77 03 053 292
- 16- 79 03 032 018
- 17- 77 02 056 989
- 77 02 086 442
- 18- 77 03 053 700
- 19- 79 10 019 274
- 20- 77 00 268 948
- 21- 77 01 349 125
- 22- 77 02 057 001
- 23- 77 00 588 718
- 24- 77 00 588 717
- 25- 77 00 730 830
- 26- 77 00 650 095
- 27- 77 03 075 053
- 28- 77 03 075 039
- 29- 77 03 067 250
- 30- 77 05 015 003
- 31- 79 46 006 314
- 32- 77 00 728 983
- 33- 77 03 033 042
- 34- 77 00 731 871

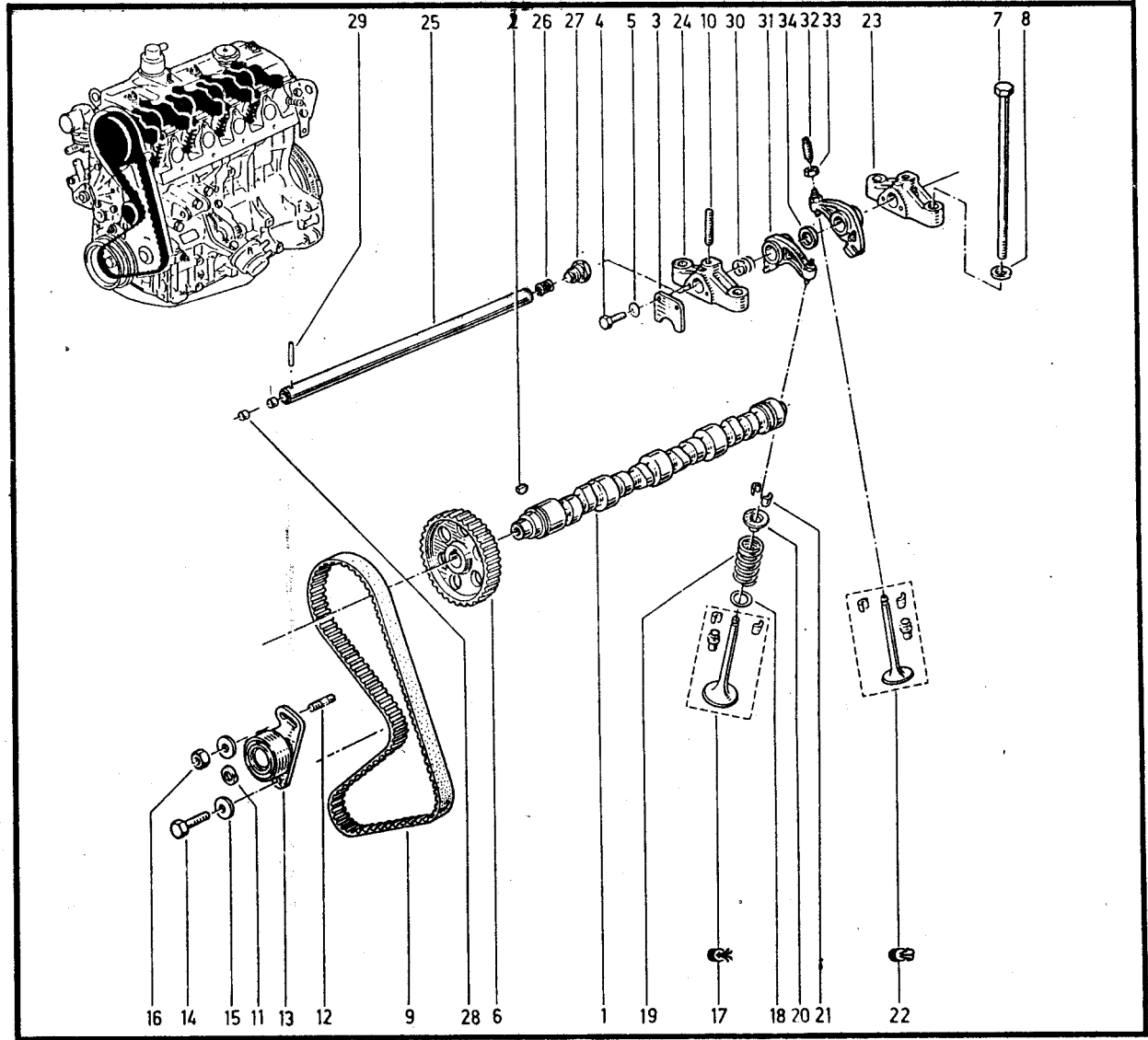

- K48X 210
- L48K 208/209
- L48X 208
- L48G 202
- K48G 202

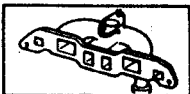

12.01

P.R. 1233

- 1- 77 00 679 643
- 2- 77 02 057 817
- 3- 77 03 032 047
- 4- 07 06 329 400
- 5- 77 02 057 929
- 6- 77 03 027 048
- 7- 77 02 086 714
- 8- 77 03 075 034
- 9- 77 02 086 669
- 10- 77 05 030 089
- 11- 77 03 075 038
- 12- 77 00 622 284
- 13- 77 02 086 404
- 14- 77 03 075 009
- 15- 77 02 056 319
- 16- 77 03 055 037
- 17- 77 03 053 037

12.01

P.R. 1233

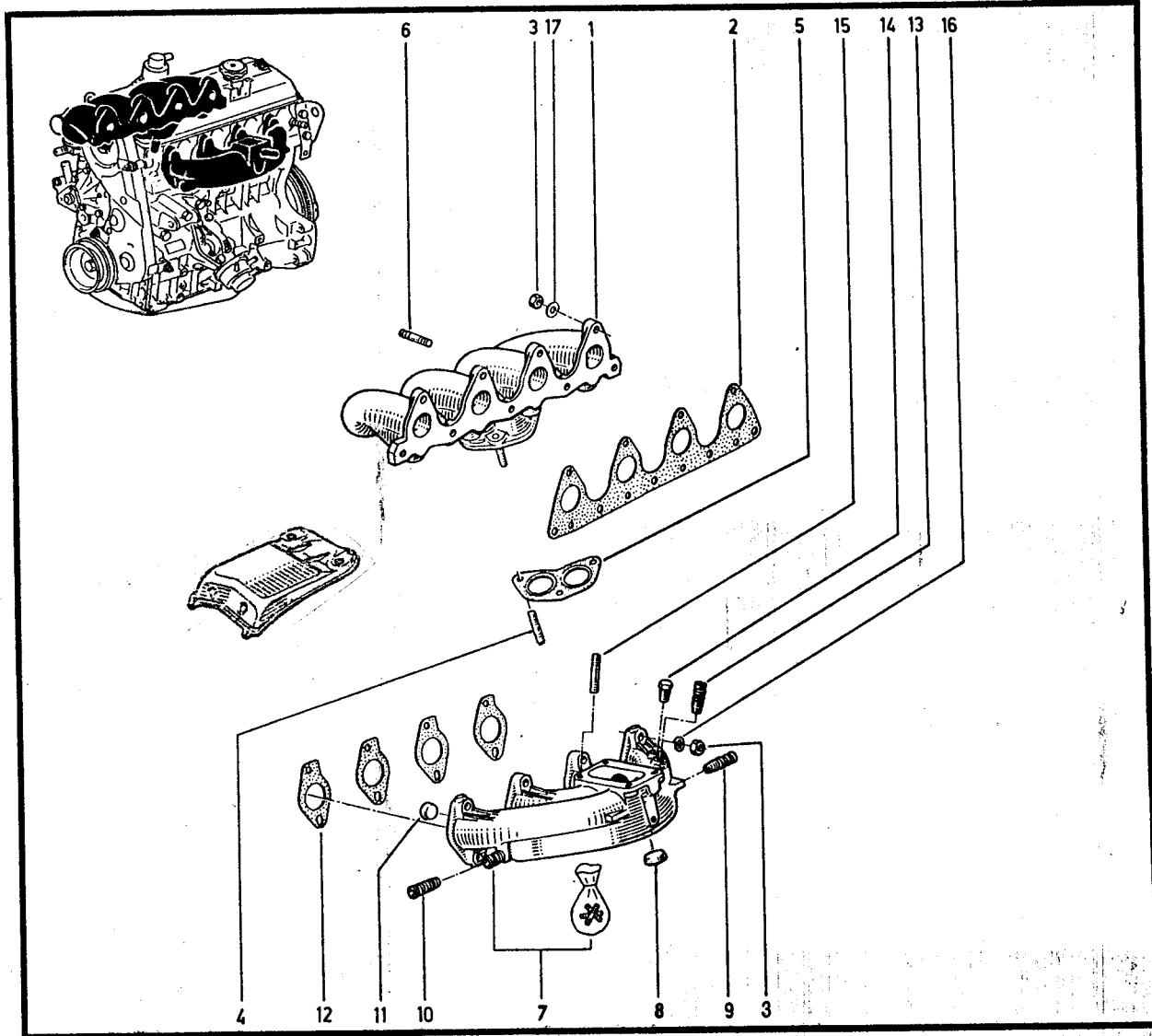
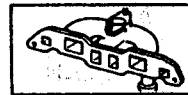

K487
K48S
L48S
L489
K489
L488
K488



12.01.1

P.R. 1233

Injection

12.01.1

P.R. 1233



- 1- 77 00 734 965 (37)
- 2- 77 05 030 090
- 3- 77 00 853 902
- 4- 77 03 055 037
- 5- 79 03 032 018
- 6- 77 00 729 139
- 7- 77 00 704 696
- 8- 77 00 853 903
- 9- 77 03 001 160
- 10- 77 03 053 037
- 11- 77 03 055 011
- 12- 77 00 679 643
- 13- 77 02 057 817
- 14- 77 03 032 047
- 15- 77 02 057 929
- 16- 77 03 027 048
- 17- 77 03 074 097
- 18- 77 00 711 847
- 19- 07 06 329 400

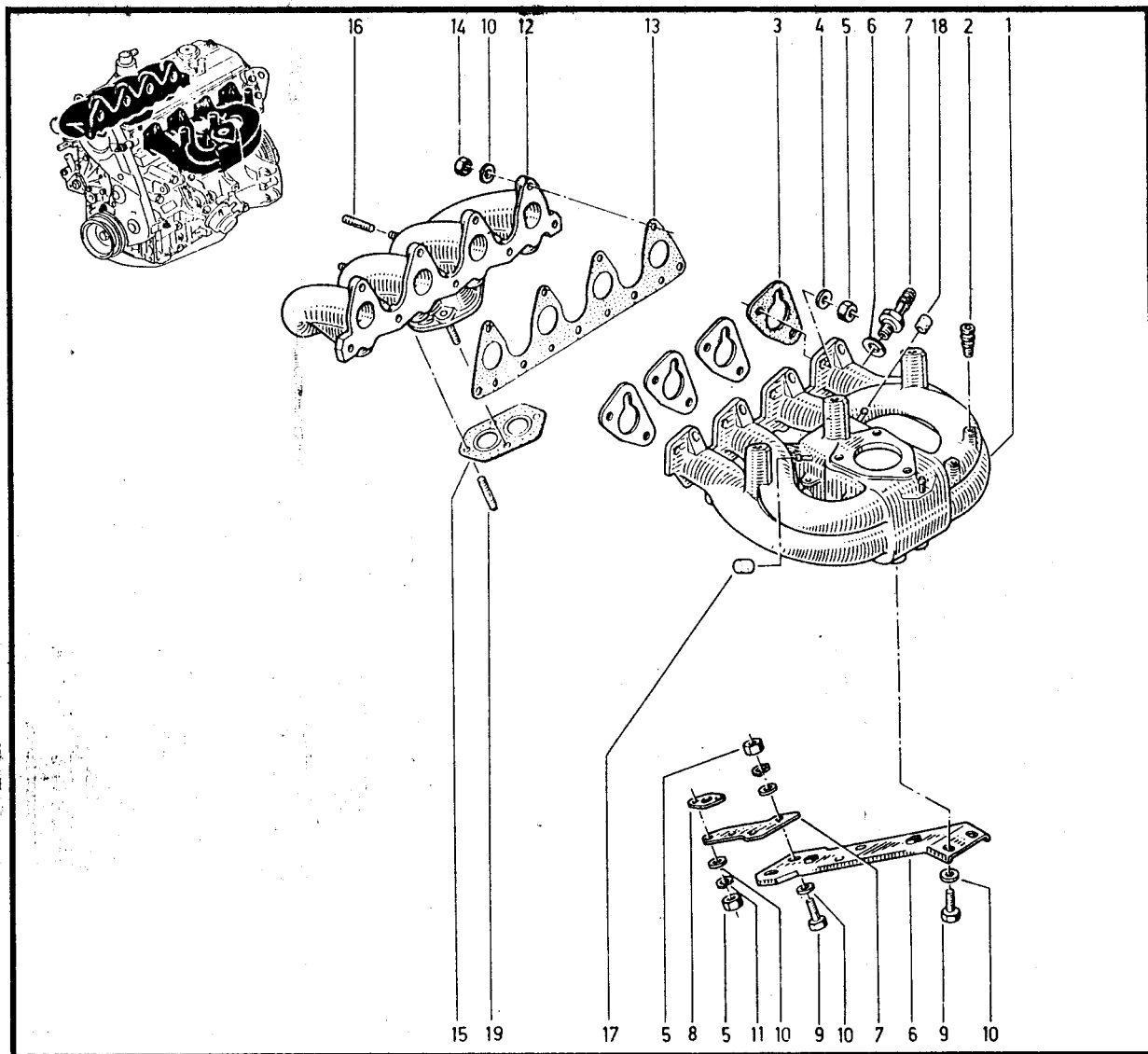

- K48Y
- L48Z
- L48Y
- K48X
- L48X
- K48G
- L48K
- L48G

(37) 7700711847-1
7703074097-1

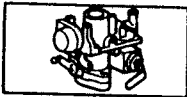

12.13

P.R. 1233

SOLEX 34 T.E.I.E.

12.13

P.R. 1233

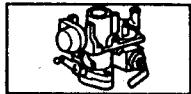

- 1- 77 02 087 291 (a)
- 77 02 087 035 (b)
- 77 02 087 234 (c)
- 77 02 087 197 (d)
- 77 02 087 442 (c)
- 2- 77 02 206 991 (b)
- 77 02 206 992 (d)
- 77 02 089 195 (a)(b)
- 3- 77 02 088 854
- 4- 77 02 088 837
- 5- 77 02 088 849
- 6- 77 02 088 846
- 7- 77 02 088 848
- 8- 77 02 088 827
- 9- 77 00 851 094

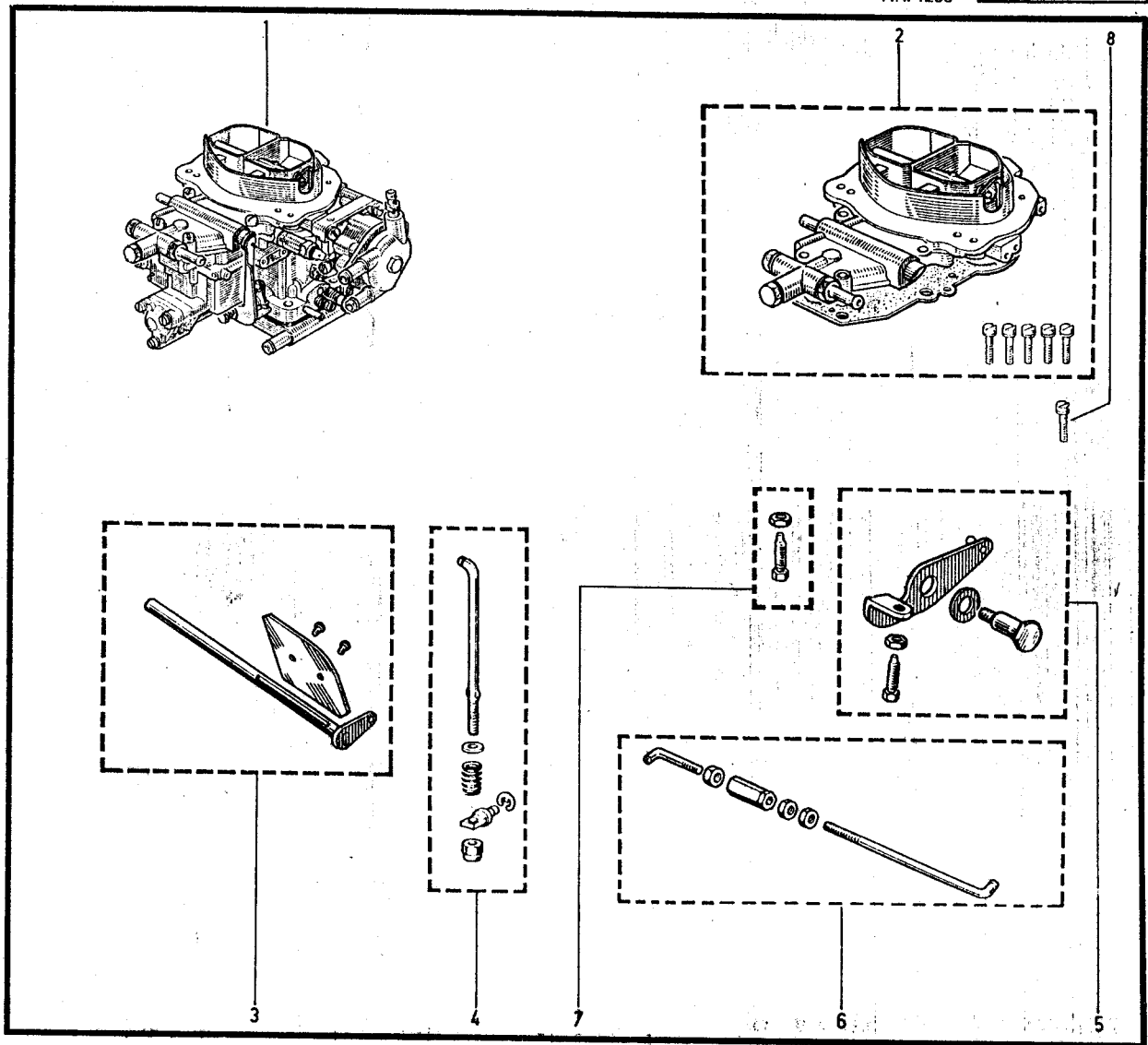

K487 089
K48S 092
L48S 091
 (a) K48S 090
K488 089
L488 089

K489 089
 (b) L489 089
K488 202/212
 (c) L488 202/212

K48S 204
 (d) L48S 208
K48S 210

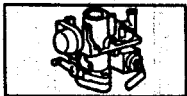

12.14

P.R. 1233

SOLEX 34 T.E.I.E.

12.14

P.R. 1233

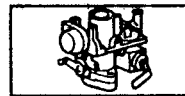

- 1- 77 00 088 842
- 2- 77 02 088 841
- 3- 77 02 088 840
- 4- 77 02 206 869
- 5- 77 02 088 800

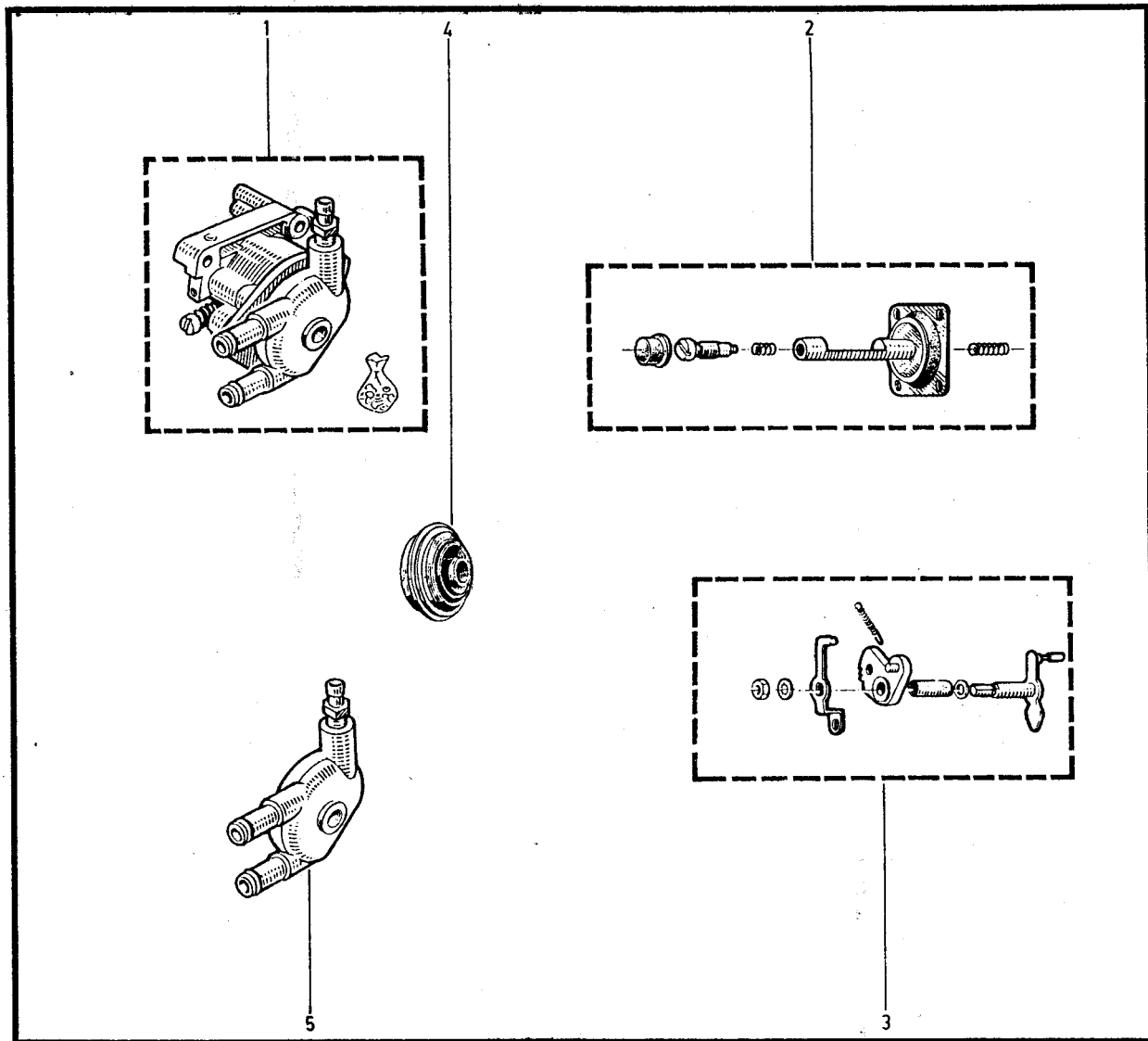



12.15.1
P.R. 1233

Injection

12.15.1
P.R. 1233



- 1- 77 00 737 125 (a)
- 2- 79 03 057 005
- 3- 77 03 009 104
- 4- 77 00 267 481
- 5- 77 00 680 341
- 6- 77 03 053 654
- 7- 77 03 006 116
- 8- 77 00 535 328
- 9- 77 00 267 544
- 10- 77 00 736 886
- 11- 77 03 066 153
- 12- 77 03 076 066
- 13- 77 00 740 205
- 14- 77 03 053 338
- 15- 77 01 203 179
- 16- 77 01 029 574
- 17- 77 02 220 567 (b)

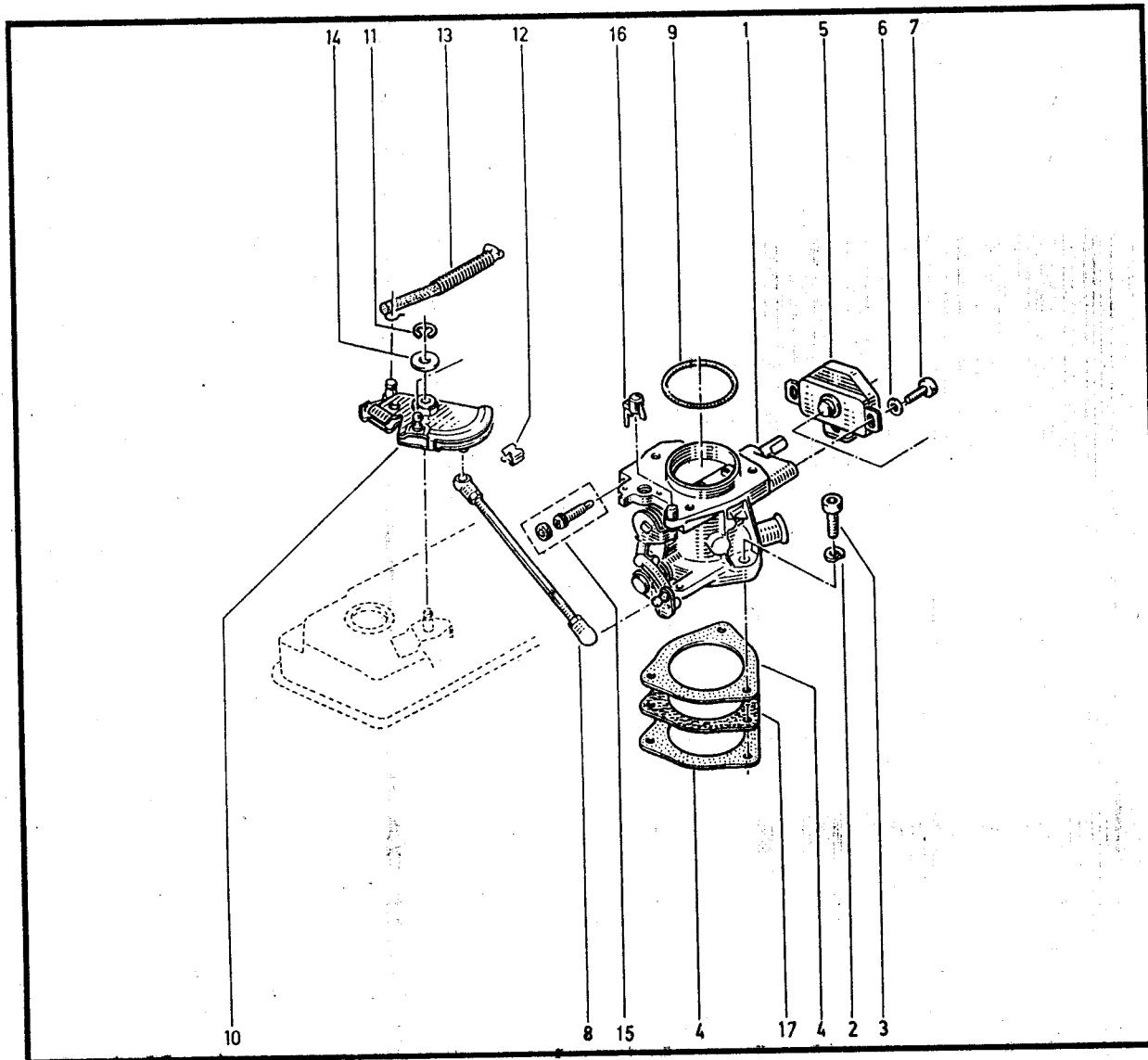

(a)	K48Y	(b) /	L48G 202
	L48Z		K48G 202
(a)	L48Y		
	K48X		
	L48X		
	K48G		
	L48K		
	L48G		

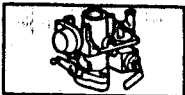

12.16
P.R. 1233

SOLEX 34 T.E.I.E.

12.16
P.R. 1233

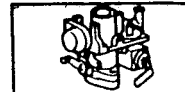

- 1- 77 02 088 819
- 2- 77 02 206 331
- 3- 77 02 089 193 (a)
- 77 02 206 985 (b)
- 4- 77 02 088 836
- 5- 77 02 089 194

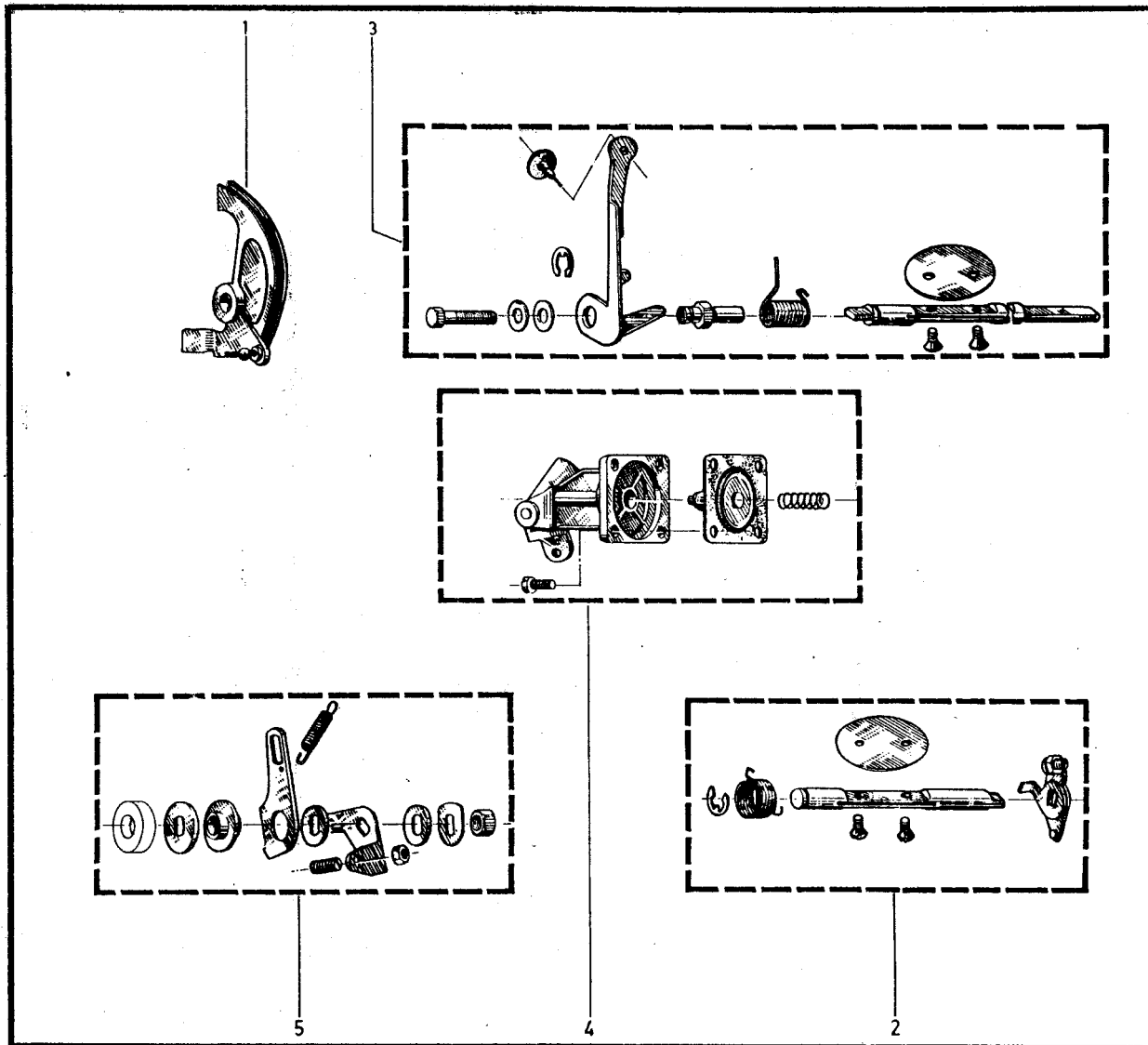

	K487 089		
	K48S 092/090	(a)	K48S 204/210
	L48S 091		L48S 208
(a)	K488 089	(b)	K488 202
	L488 089		L488 202

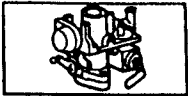

12.22

P.R. 1233

SOLEX 34 T.E.I.E.

12.22

P.R. 1233

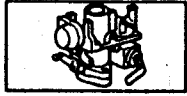

- 1 - 77 02 088 843
- 2 - 77 02 088 835
- 3 - 77 02 088 821
- 4 - 77 02 023 348
- 5 - 77 02 086 169

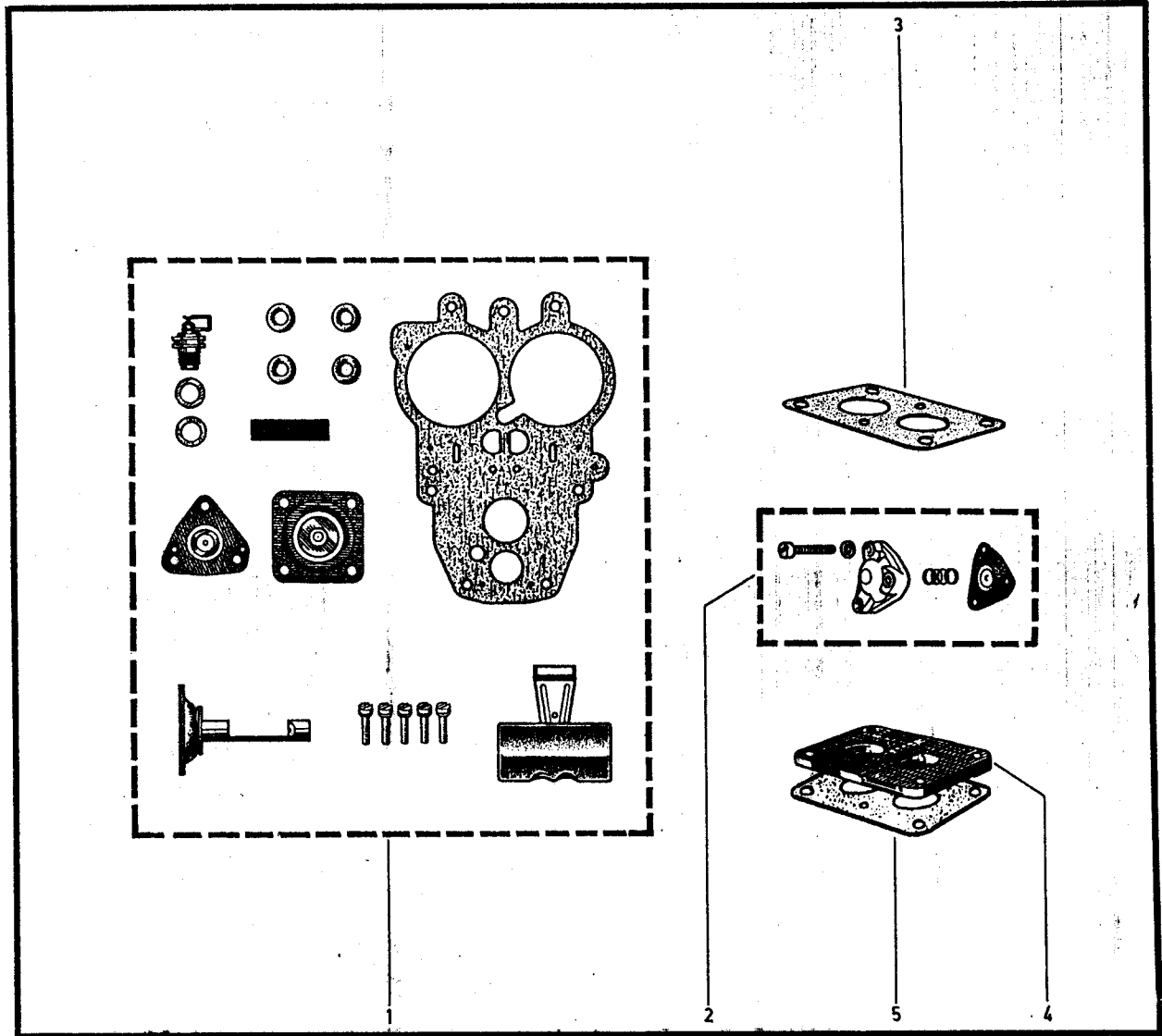

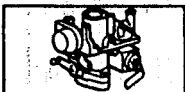

12.23

P.R. 1233

SOLEX 34 T.E.I.E.

12.23

P.R. 1233

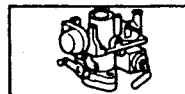

- 1- 77 02 088 832
- 2- 77 02 088 833
- 3- 77 02 088 831
- 4- 77 02 088 830
- 5- 77 02 088 829
- 6- 77 02 088 828
- 7- 77 02 206 325
- 8- 77 02 088 826
- 9- 77 02 088 824
- 10- 77 02 088 823
- 11- 77 02 089 198
- 12- 77 02 088 812
- 13- 77 02 089 196
- 14- 77 02 089 196
- 15- 77 02 088 809
- 16- 77 02 089 197
- 17- 77 02 052 052
- 18- 77 02 052 043
- 19- 77 02 088 807
- 20- 77 02 088 798
- 21- 77 02 206 330
- 22- 77 02 206 332
- 23- 802614445
- 24- 77 02 206 328
- 25- 77 02 206 329

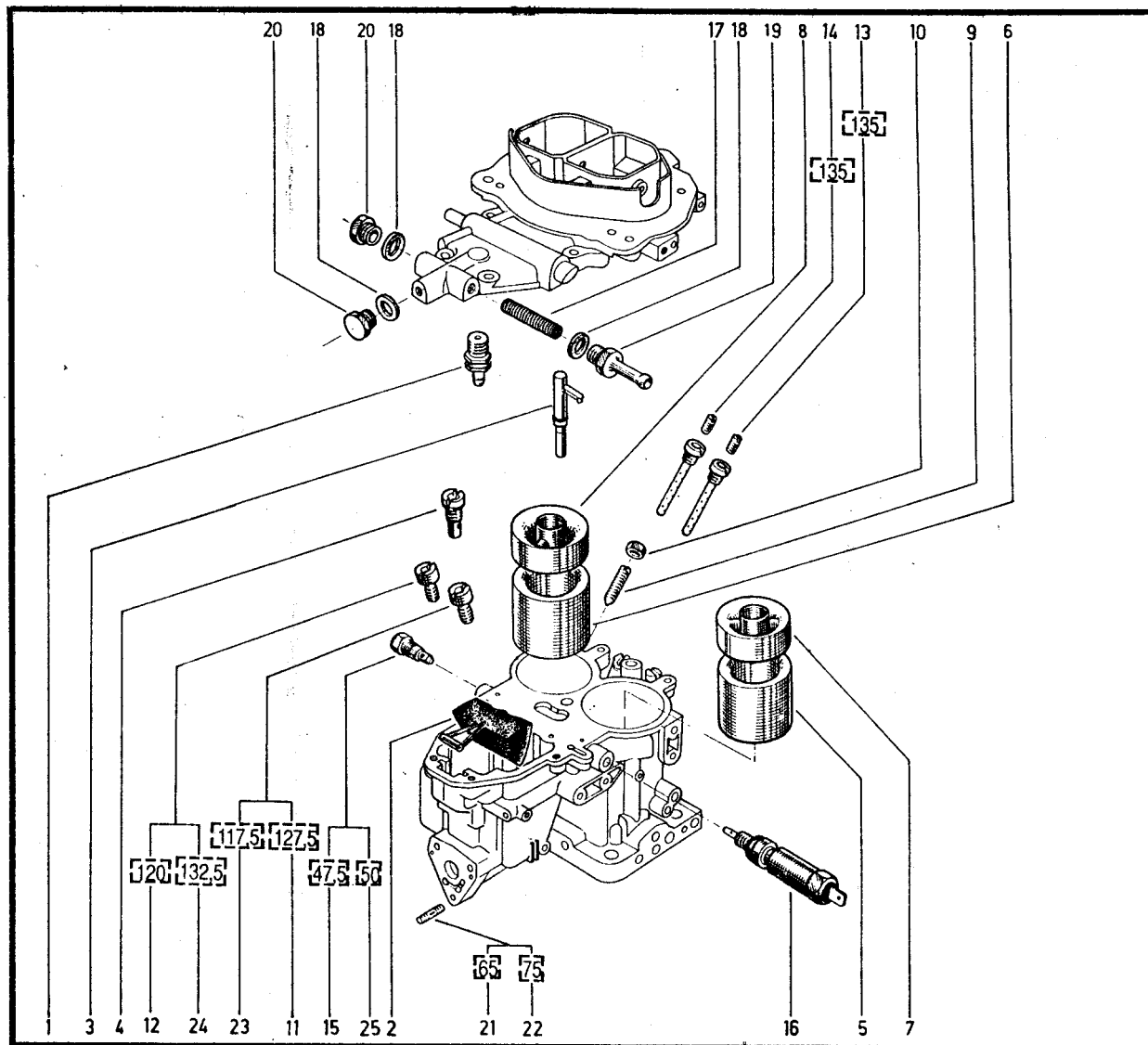

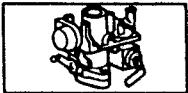

12.24

P.R. 1233

SOLEX 34 T.E.I.E.

12.24

P.R. 1233



- 1-77 02 088 817 (a)
- 77 02 206 989 (b)
- 2-77 02 088 816
- 3-77 02 088 834
- 4-77 02 088 815
- 5-77 02 088 856
- 6-77 02 052 048
- 7-77 01 001 859
- 8-77 02 088 818
- 9-77 02 088 799
- 10-77 03 066 071
- 11-77 02 052 049
- 12-77 02 088 806
- 13-77 02 088 853
- 14-77 02 088 855
- 15-77 02 088 801
- 16-77 02 088 805
- 17-77 02 052 077
- 18-77 02 206 986 (b)
- 77 02 206 987 (b)
- 19-77 02 206 990 (b)

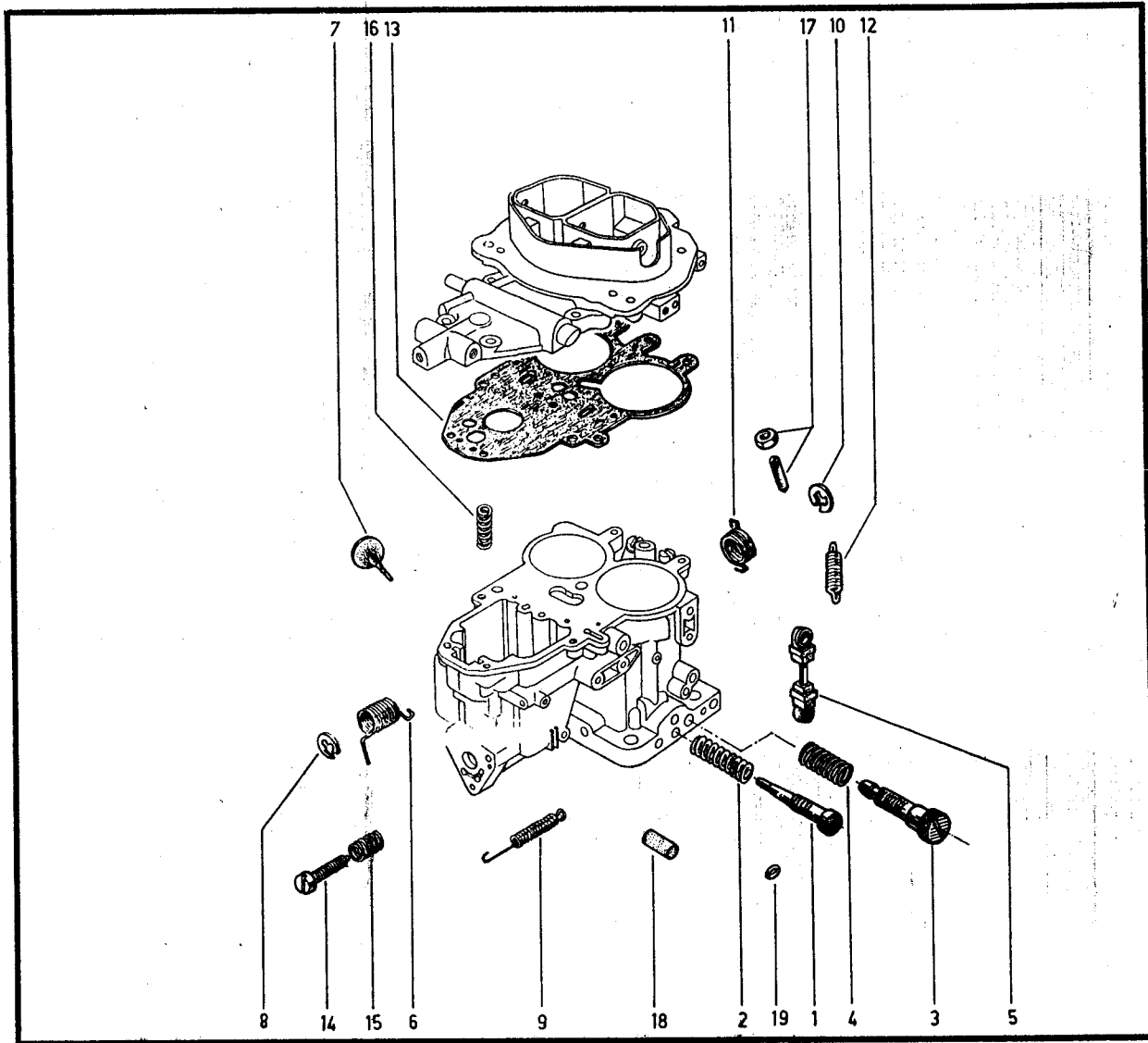

(a)	K48S 092
	L48S 091
	K48S 090
	K488 089
	L488 089
	K487 089

(b)	K48S 204
	L48S 208
	K48S 210
	K488 202
	L488 202
	L489 089
	K489 089

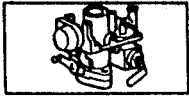

12.29
P.R. 1233

SOLEX 34 T.E.I.E.

12.29
P.R. 1233

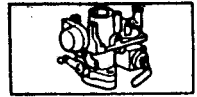

- 1- 77 02 206 082
- 2- 77 02 206 083
- 3- 77 02 089 190
- 4- 77 02 089 192

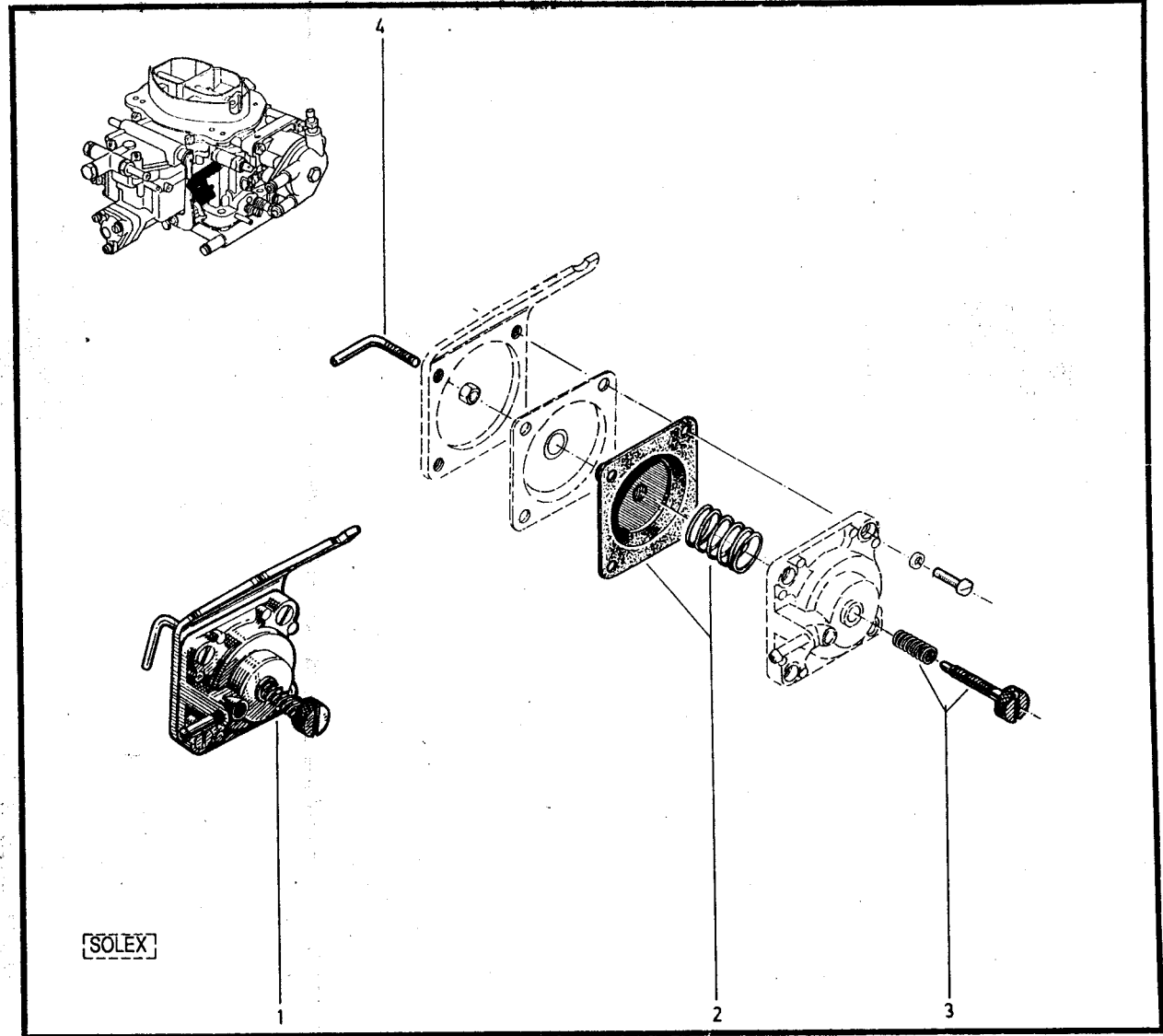

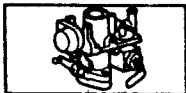

12.31

P.R. 1233

1-77 02 088 844
2-77 02 088 802
3-77 02 088 803

SOLEX 34 T.E.I.E.

12.31

P.R. 1233

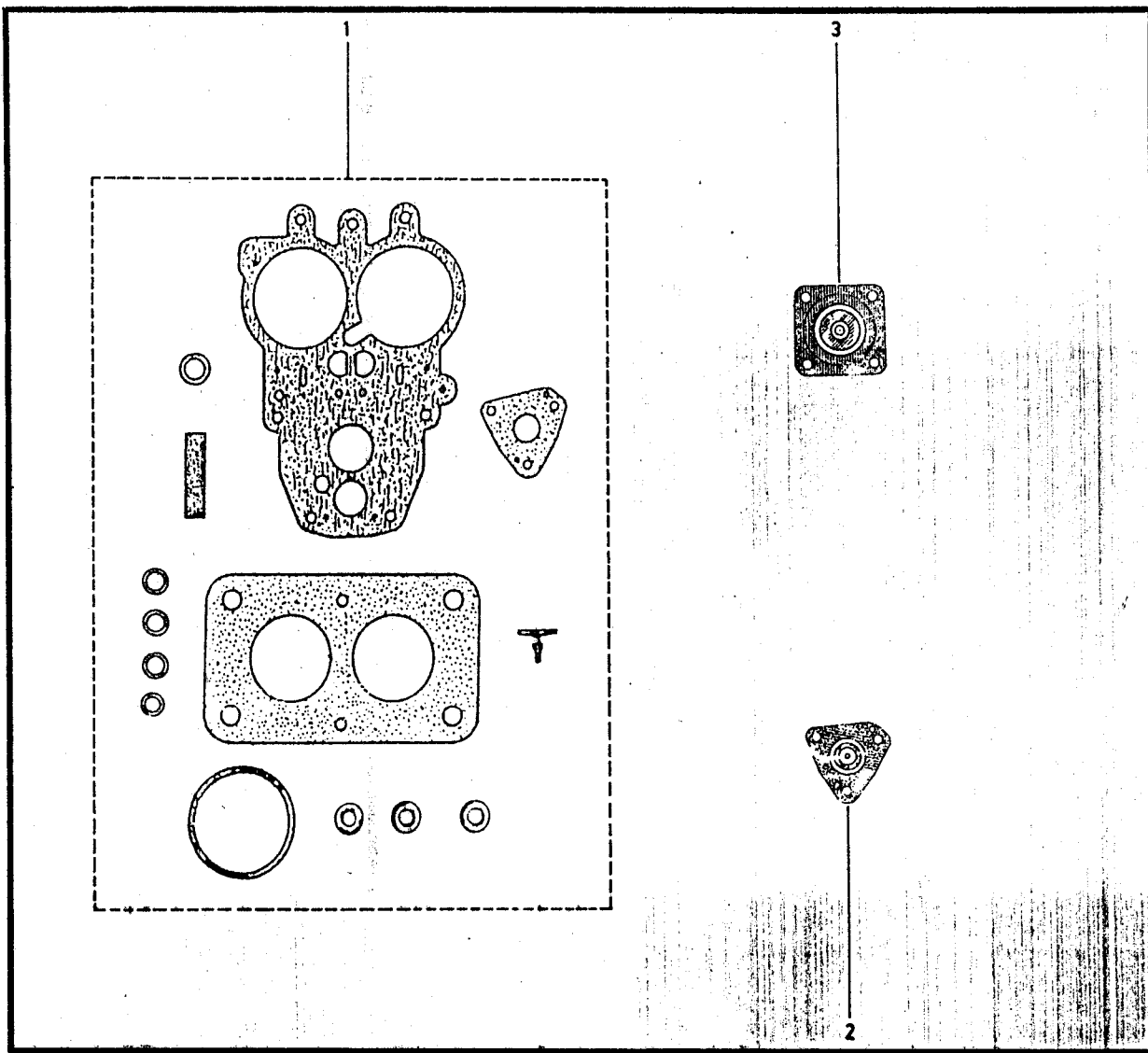
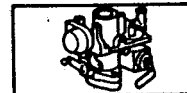



12.40

P.R. 1233

- 1-77 00 733 371
- 2-77 00 727 246
- 3-77 02 220 613
- 4-77 00 735 749
- 5-77 03 001 946
- 6-77 05 026 798 †
- 7-77 00 731 309 †
- 8-77 00 722 459

12.40

P.R. 1233

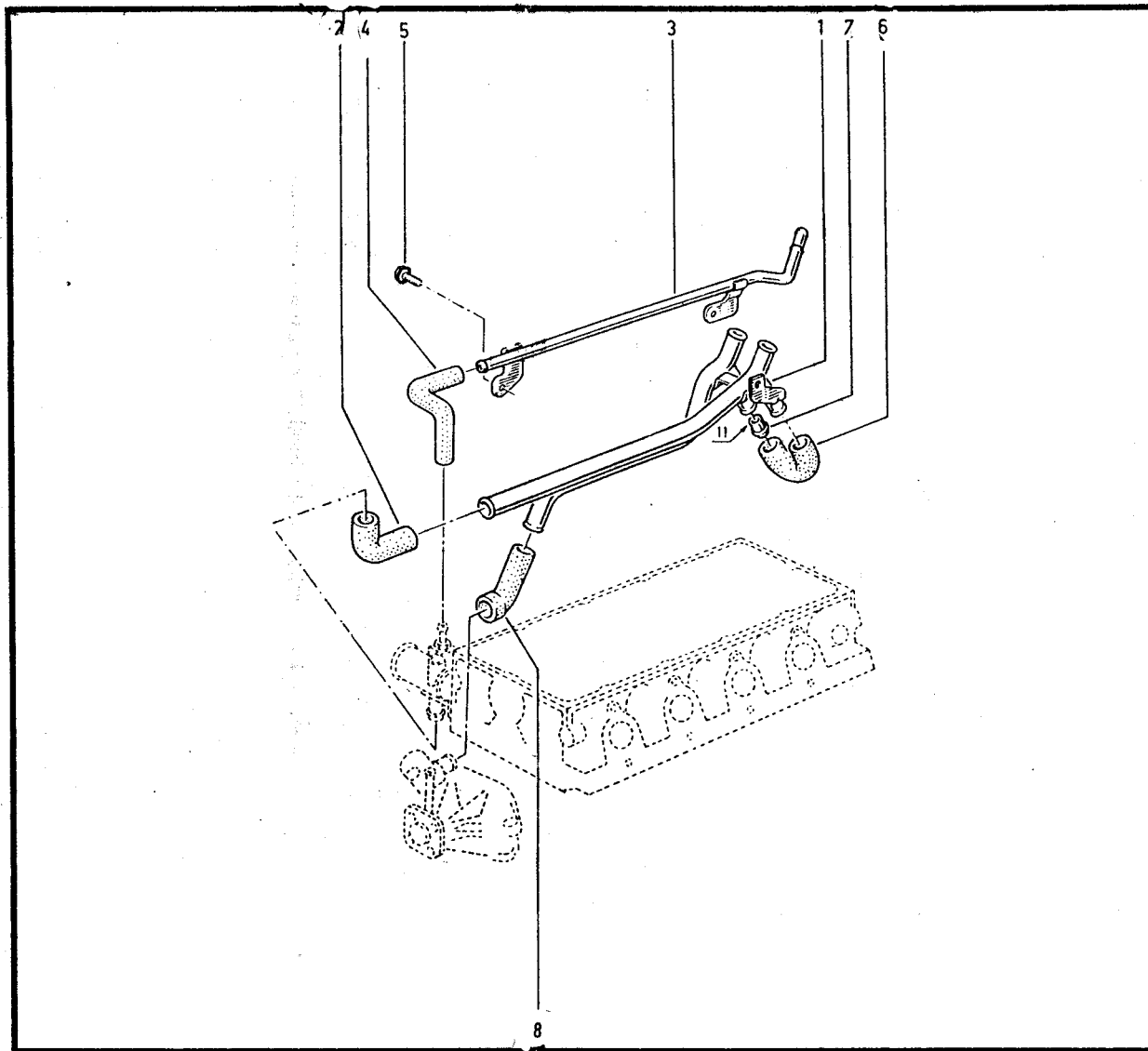
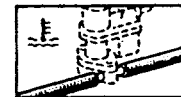

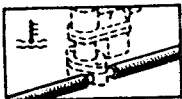

12.41

P.R. 1233

L48S - K48S

12.41

P.R. 1233

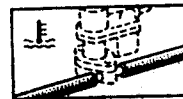

- 1 - 77 02 086 586
- 2 - 77 02 086 590
- 3 - 77 02 086 716 ^o
- 4 - 77 02 086 588 •
- 5 - 77 05 030 057
- 6 - 77 05 030 155
- 7 - 77 02 086 692
- 8 - 77 02 086 589

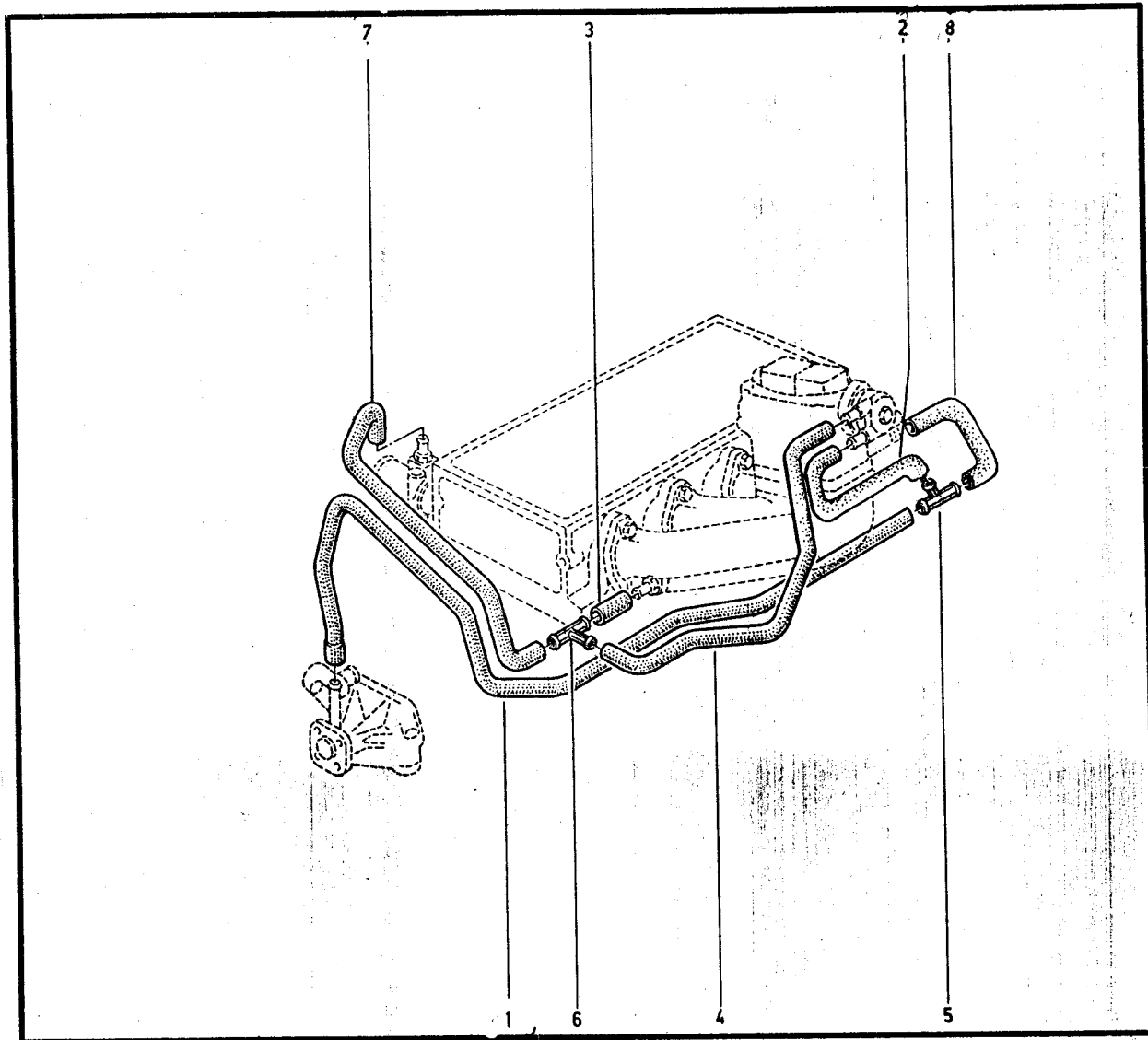



12.42

P.R. 1233

- 1- 77 02 086 586
- 2- 77 02 087 444
- 3- 77 02 086 716
- 4- 77 02 086 588
- 5- 77 05 030 057
- 6- 77 05 030 155
- 7- 77 02 086 692
- 8- 77 02 086 589
- 9- 77 02 087 445

12.42

P.R. 1233

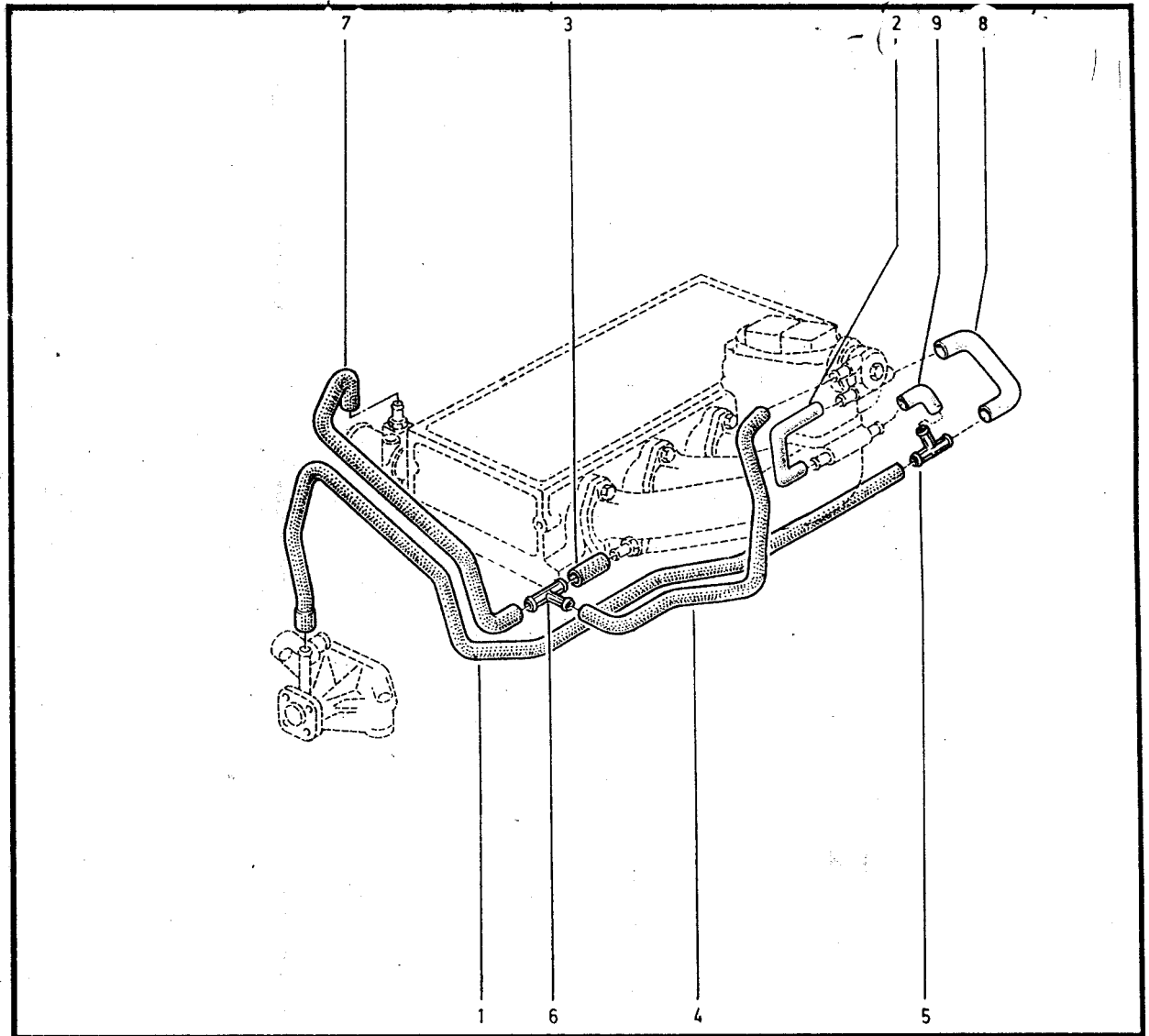
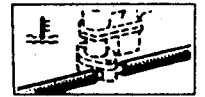

- K487 089
- K48S 090
- K48S 092
- K488 089
- L48S 091/090
- L488 089



12.55.3

P.R. 1233

Injection

12.55.3

P.R. 1233



- 1- 77 00 727 796
- 2- 77 03 001 123
- 3- 77 03 055 007
- 4- 77 02 087 283
- 5- 77 00 727 701
- 6- 77 01 033 227 [✱]
- 7- 77 00 860 127
- 8- 77 00 729 903
- 9- 77 00 729 914
- 10- 77 03 001 865
- 11- 77 00 739 358 ✕ 1m

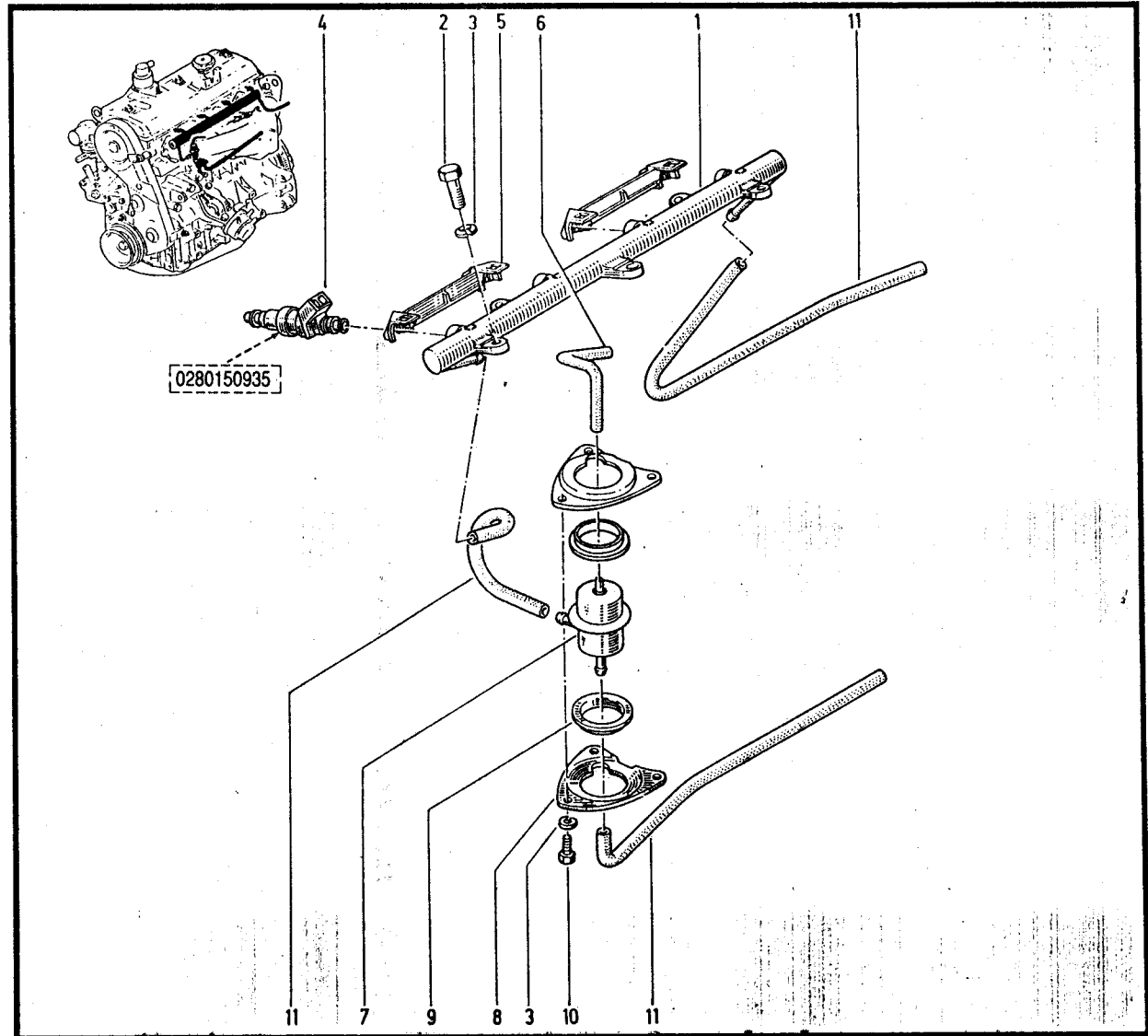

K48Y 092/090
L48Z 091/095
L48Y 091



12.55.4
P.R. 1233

Injection

12.55.4
P.R. 1233



- 1- 77 02 087 278
- 2- 77 03 001 123
- 3- 77 03 055 007
- 4- 77 02 087 283
- 5- 77 00 727 701
- 6- 77 01 033 227
- 7- 77 02 087 282
- 8- 77 00 729 903
- 9- 77 00 729 914
- 10- 77 03 001 120
- 11- 77 00 739 358 \times 1m

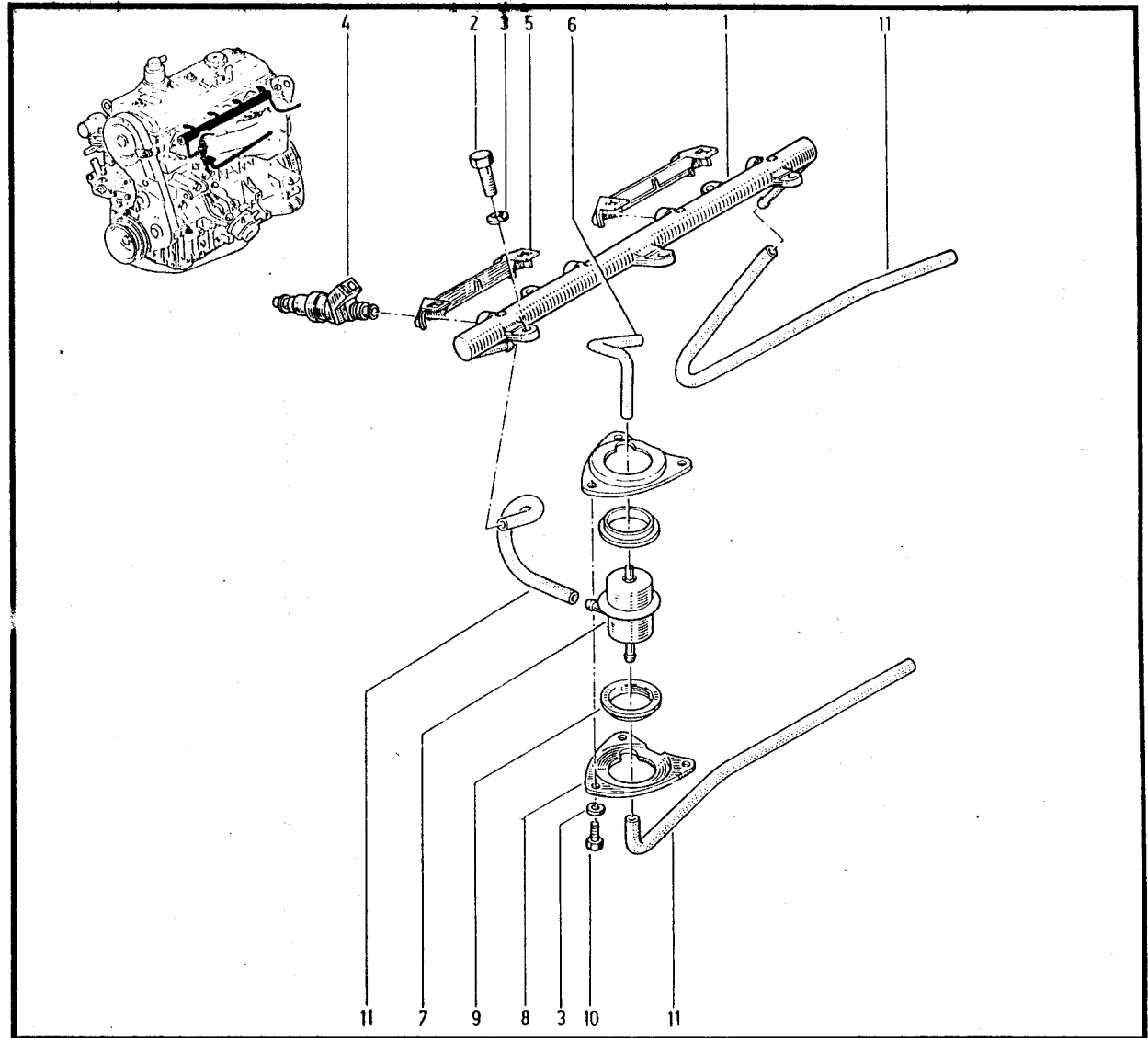

- K48X 210
- L48K 208/209
- L48X 208
- L48G 202
- K48G 202

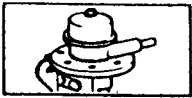

13.01

P.R. 1233

13.01

P.R. 1233



- 1- 77 02 086 763 (A)
- 77 02 087 140 (B)
- 2- 77 01 200 820 (1)
- 3- 77 03 065 088
- 4- 77 00 663 431
- 5- 79 03 053 043
- 6- 77 03 055 011
- 7- 79 03 032 018
- 8- 77 02 073 147
- 9- 77 02 057 176
- 10- 77 03 001 018

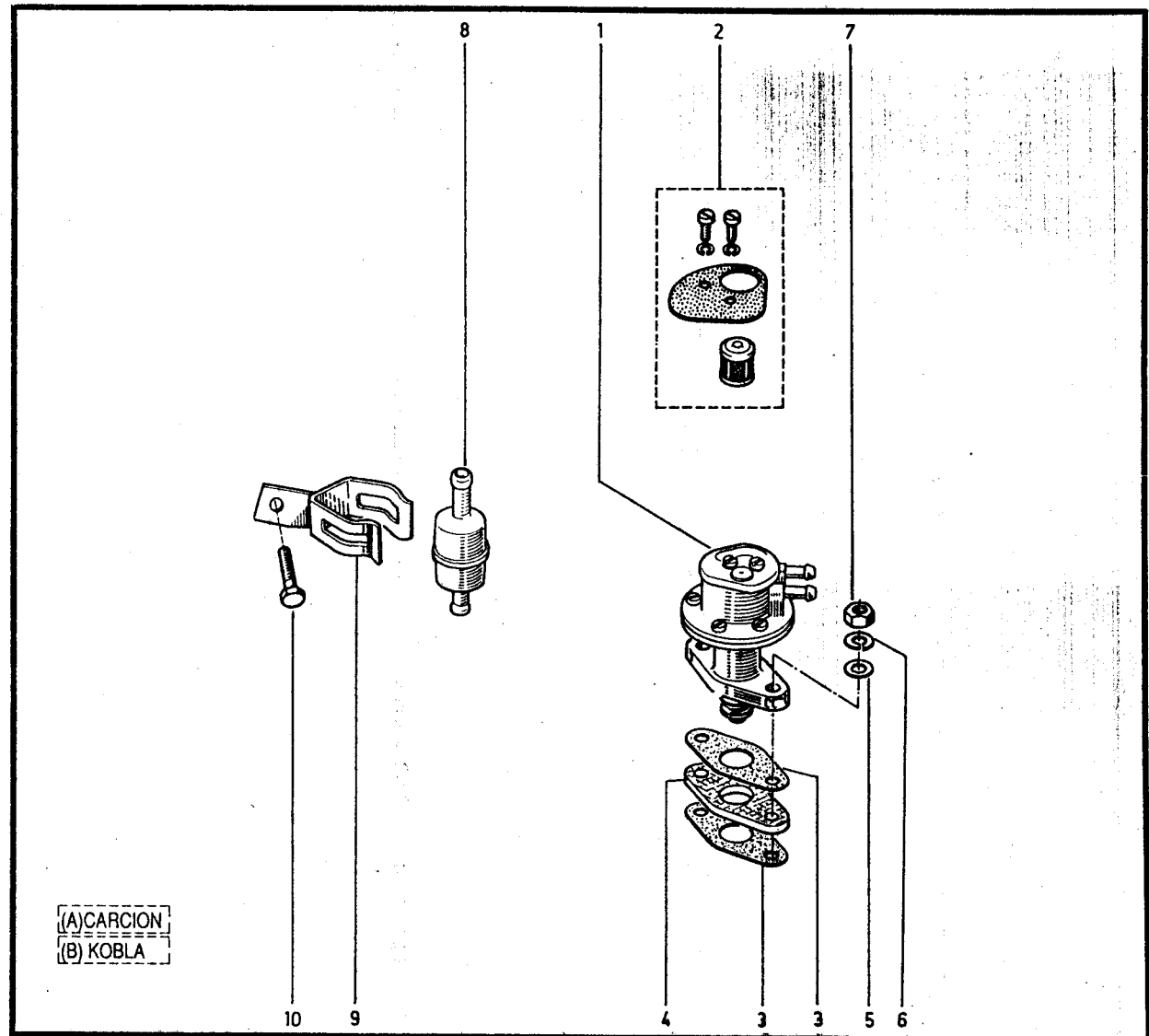

- K487
- K48S
- L48S
- L489
- K489
- L488
- K488

(1) 7700690477

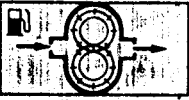

13.03.1

P.R. 1233

Injection

13.03.1

P.R. 1233

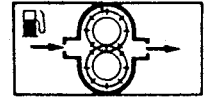

- 1- 77 00 855 358
- 2- 77 00 737 141
- 3- 77 00 742 386
- 4- 77 04 001 666
- 5- 77 00 676 262
- 6- 77 00 807 927
- 7- 77 05 005 195
- 8- 77 00 856 767
- 9- 77 00 771 672
- 10- 77 04 002 509

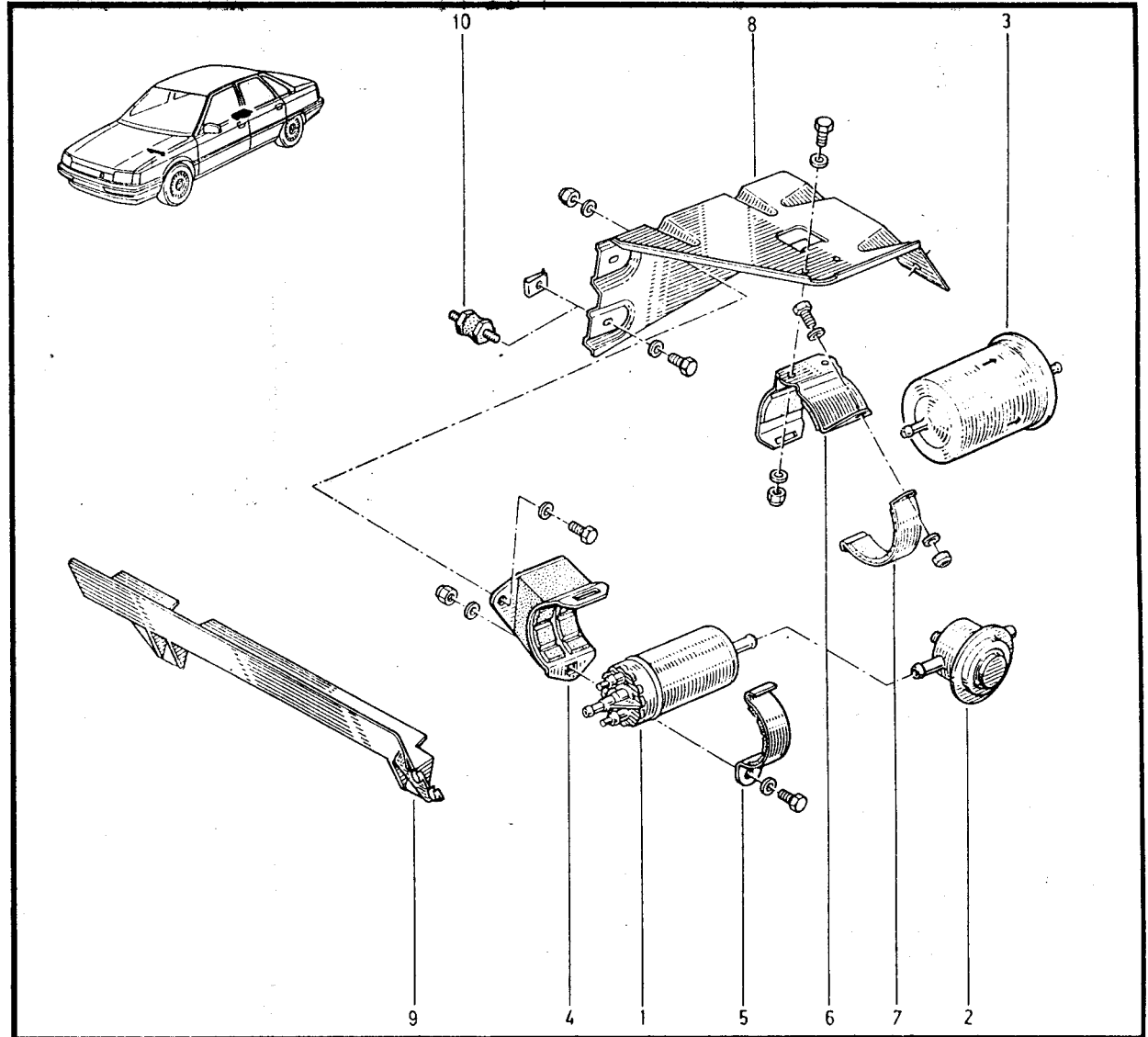

K48Y 092/090
L48Z 091/095
L48Y 091

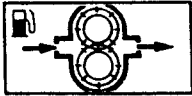

13.03.2

P.R. 1233

Injection

13.03.2

P.R. 1233

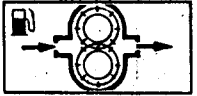

- 1 - 77 02 087 279
- 2 - 77 02 087 281
- 3 - 77 02 087 280
- 4 - 77 04 001 666
- 5 - 77 00 676 262
- 6 - 77 00 807 927
- 7 - 77 05 005 195
- 8 - 77 00 856 767
- 9 - 77 00 771 672
- 10 - 77 04 002 509
- 11 - 77 02 095 228
- 12 - 77 02 095 235

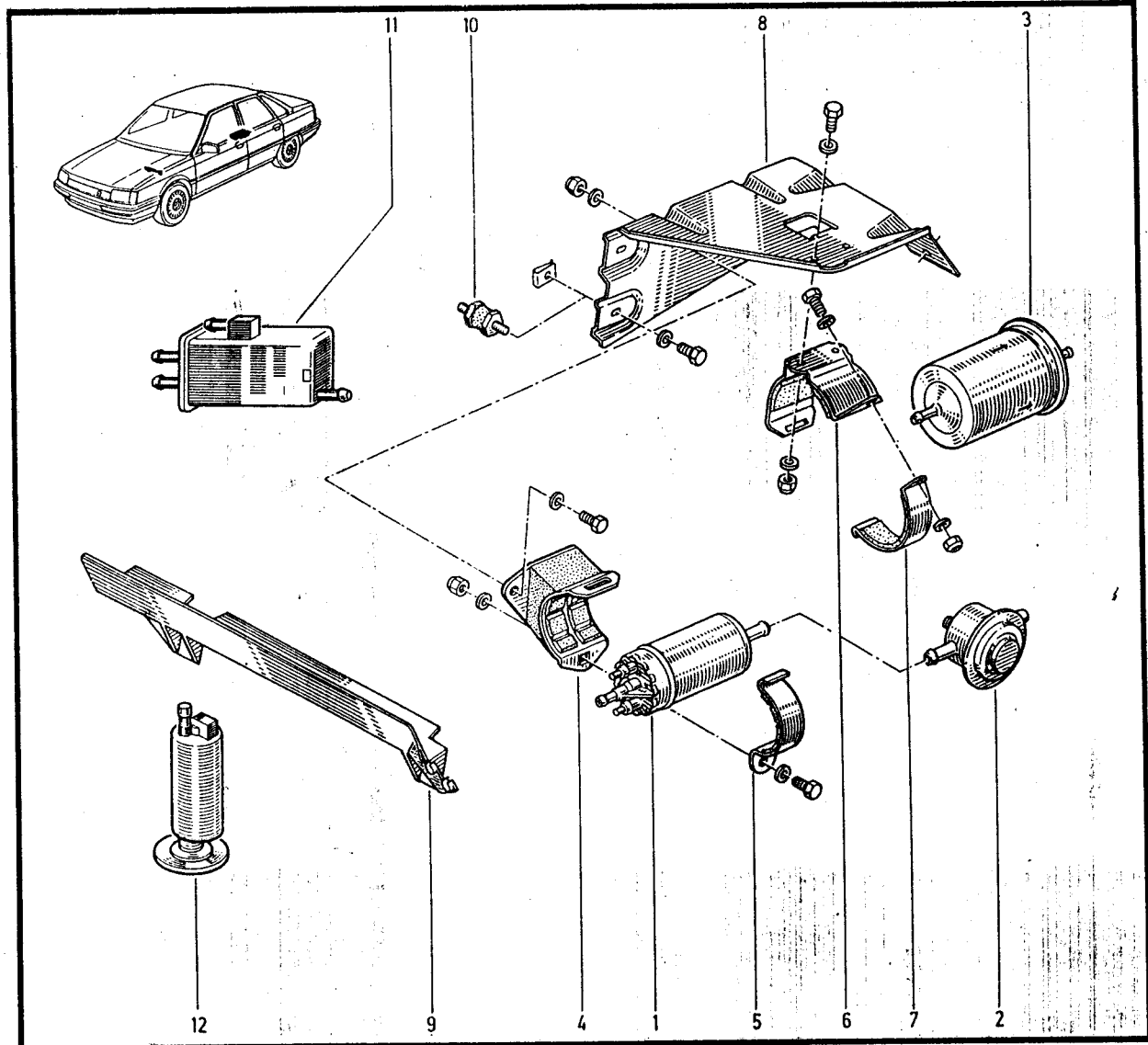

- K48X 210
- L48K 208/209
- L48X 208
- L48G 202
- K48G 202



13.20

P.R. 1233

13.20

P.R. 1233



- 1- 77 02 087 058
- 77 02 087 059
- 2- 77 02 086 967 (A)
- 77 02 089 345 (B)
- 3- 77 02 056 766
- 4- 77 02 073 140
- 5- 77 02 073 139
- 6- 77 02 206 363
- 7- 77 02 206 365
- 8- 77 02 206 366
- 9- 77 02 206 364

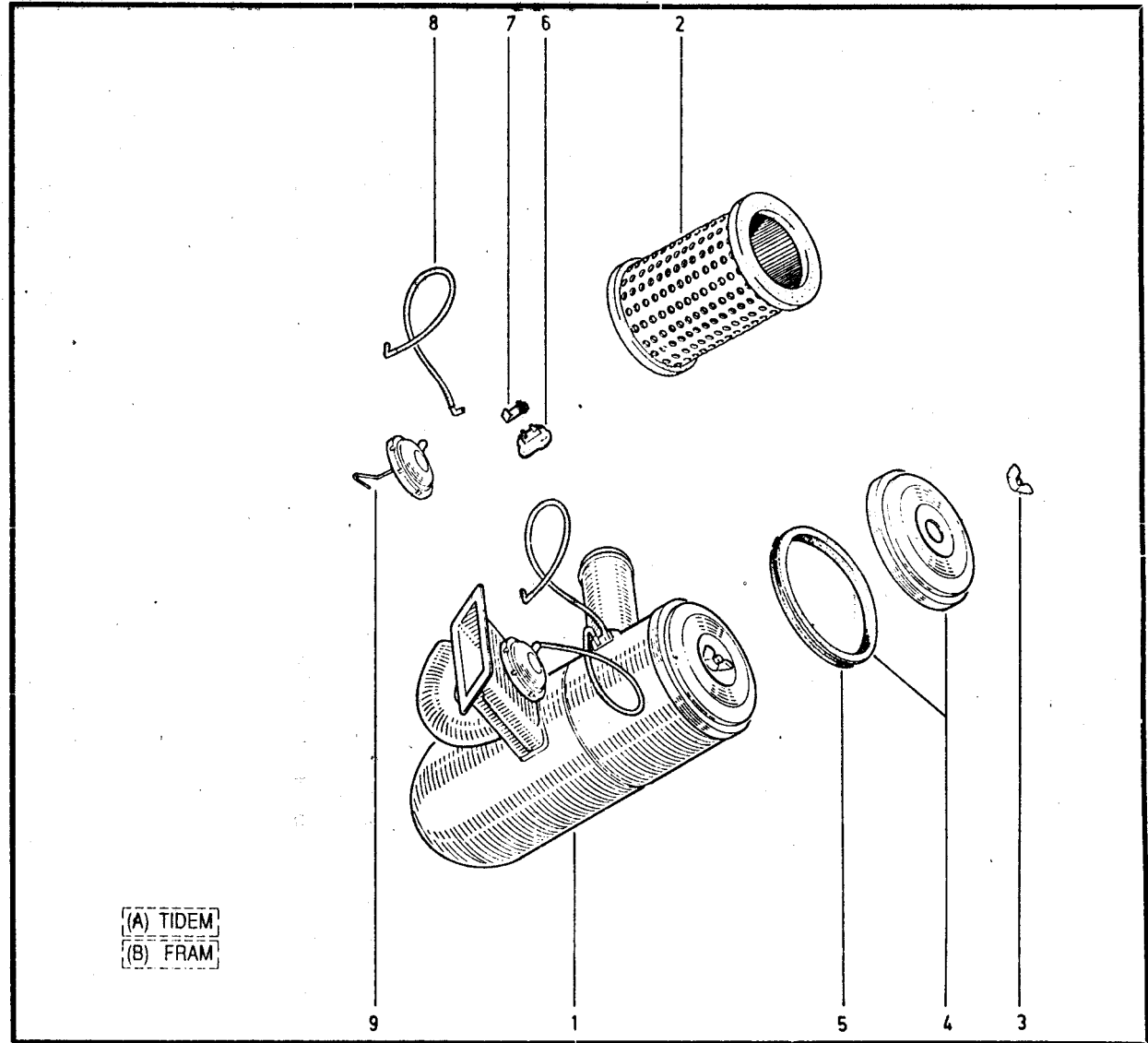

K487 089
 L48S 090/091
 L488 089
 K48S 090/092
 K488 089

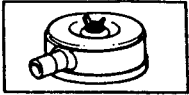

13.20.1

P.R. 1233

- 1- 77 00 731 631
- 2- 77 01 348 175
- 77 02 217 191
- 3- 77 01 033 412
- 4- 77 02 095 328

Injection

13.20.1

P.R. 1233

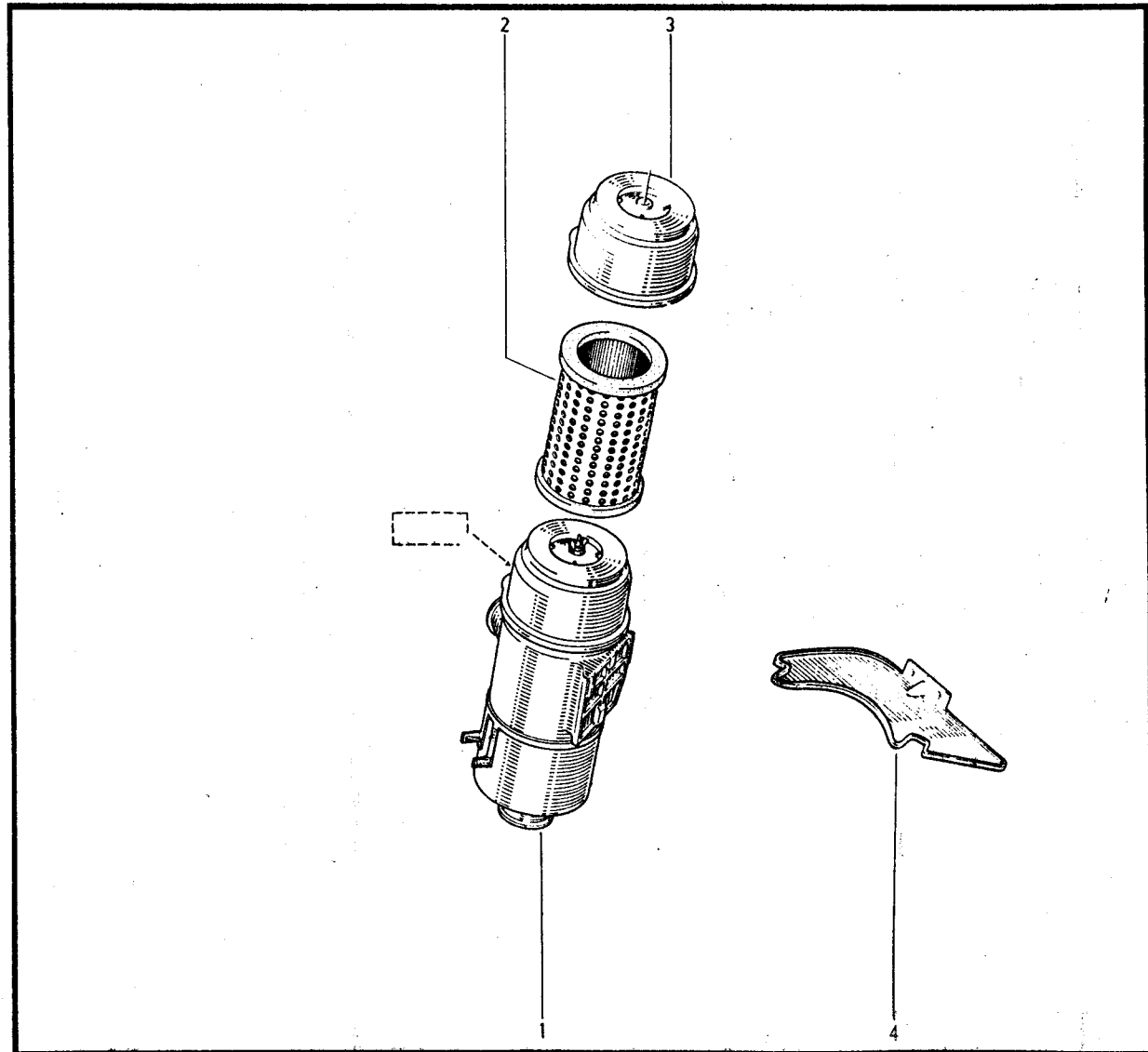
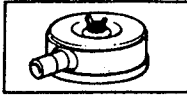

- K48Y
- L48Z
- L48Y
- K48X
- L48X
- K48G
- L48K
- L48G

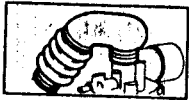

13.21

P.R. 1233

- 1- 77 02 087 238
- 2- 79 03 056 014
- 3- 77 03 032 047
- 4- 77 02 087 237 (L=1350)
- 5- 77 02 087 096
- 6- 77 02 094 656
- 7- 77 02 086 599
- 8- 79 03 053 043

13.21

P.R. 1233

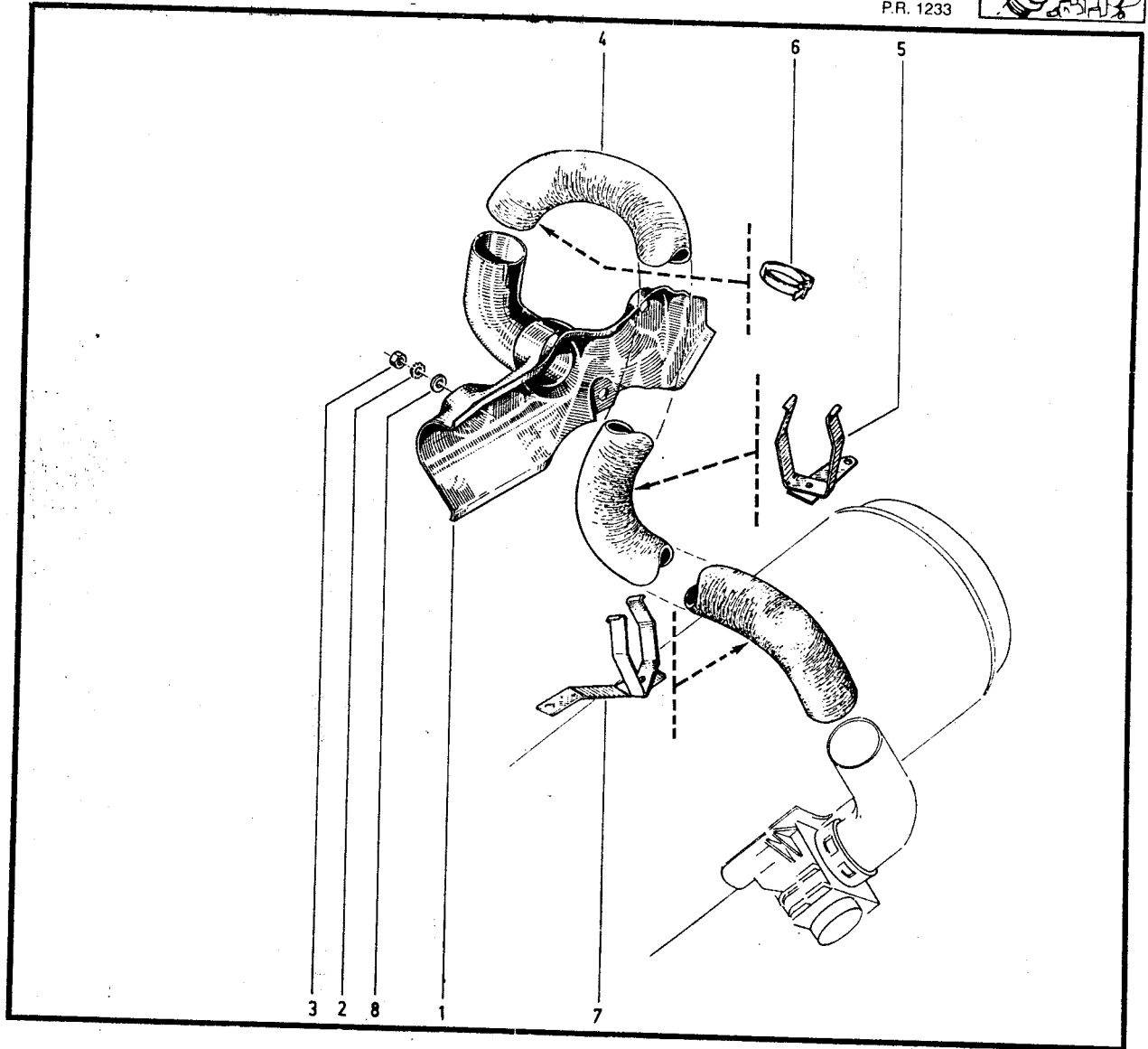
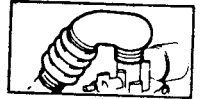

K487 089
K48S 092/090
K488 089
L48S 091/090
L488 089

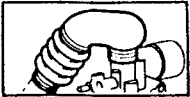

13 .22

P.R. 1233

- 1- 77 02 087 049
- 2- 77 02 094 487
- 3- 77 02 087 096

13 .22

P.R. 1233

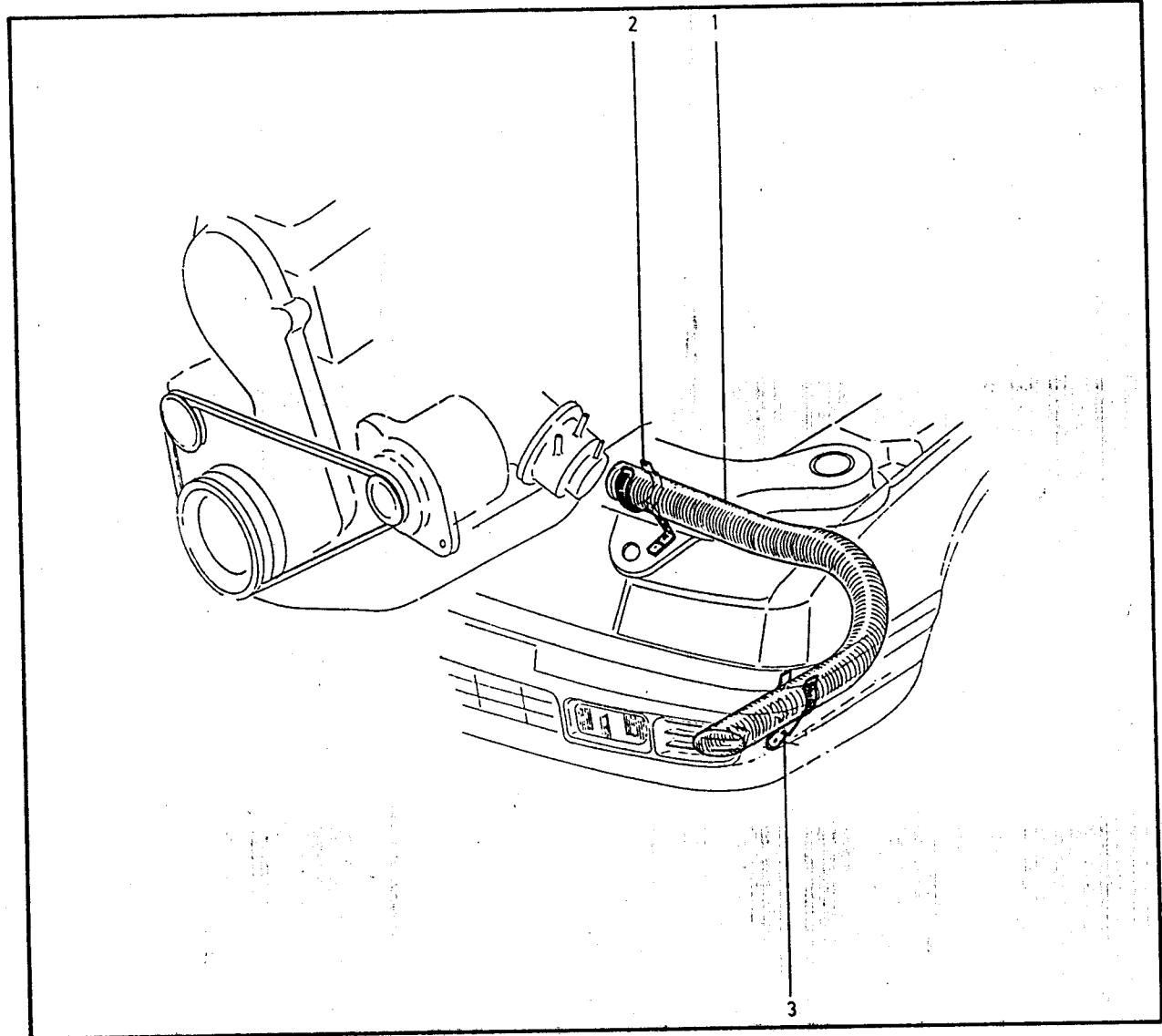
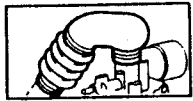

K48S
L48S
L489
K489
L488
K488
K487



13.32

P.R. 1233

Injection

13.32

P.R. 1233

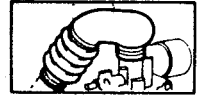

- 1- 77 00 678 712
- 2- 9.900.097
- 3- 77 00 649 042
- 4- 77 00 678 049
- 5- 77 01 033 246
- 6- 77 03 034 007
- 7- 77 03 053 029
- 8- 77 02 086 163
- 9- 77 00 666 351
- 10- 77 05 030 059
- 11- 77 02 057 939
- 12- 77 00 540 937
- 13- 77 02 086 697
- 14- 77 02 057 331
- 15- 77 01 033 227
- 16- 77 05 026 659
- 17- 77 05 030 246

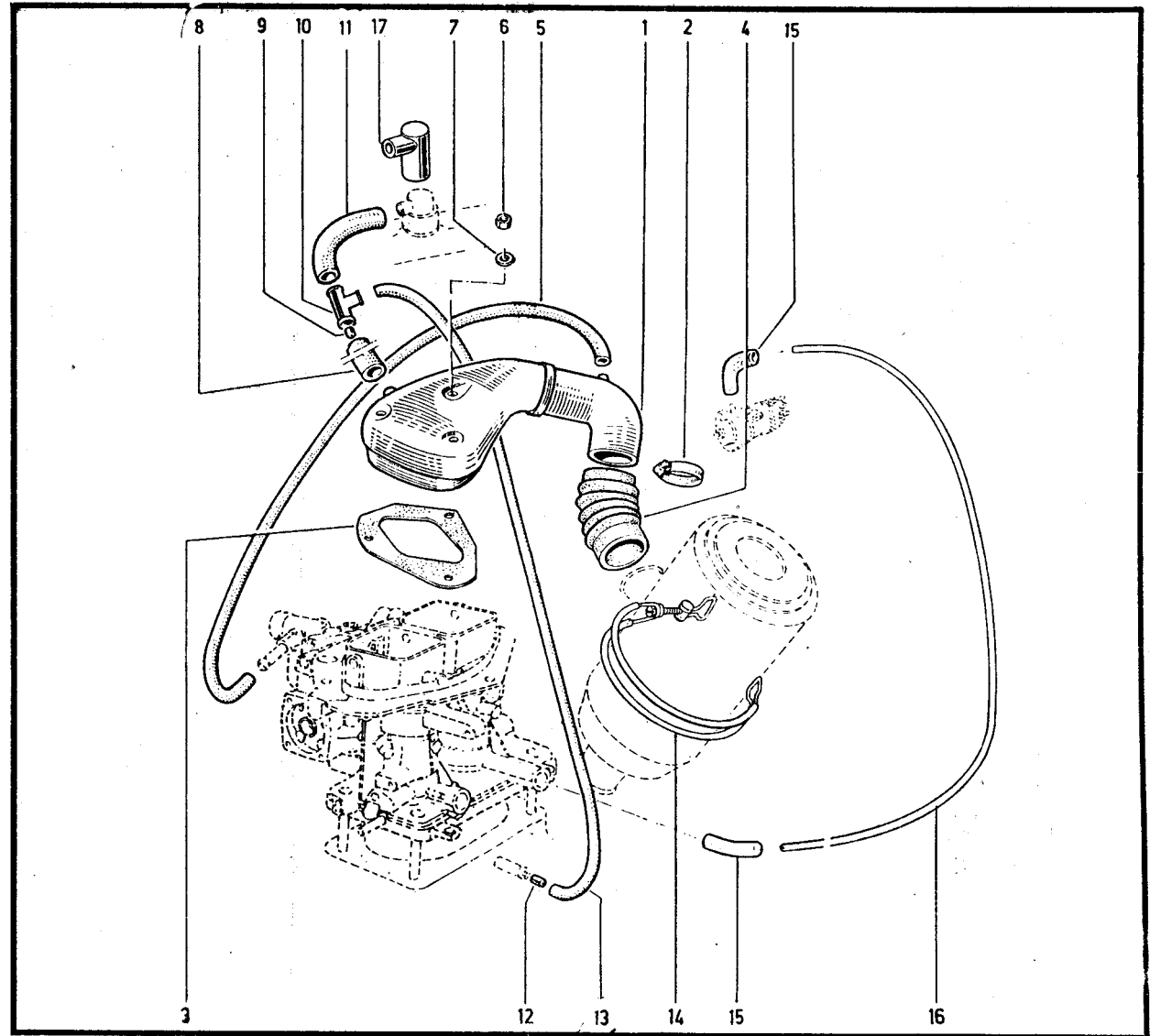

- K48S
- L48S
- L489
- K489
- L488
- K488

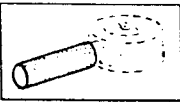

13.35.1

P.R. 1233

Injection

13.35.1

P.R. 1233

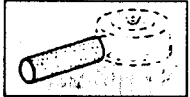

- 1- 77 00 746 160
- 2- 77 00 730 352
- 3- 77 02 087 246
- 4- 77 03 009 166
- 5- 74 01 317 957
- 6- 77 00 736 366
- 7- 77 05 005 078
- 8- 77 03 055 007
- 9- 77 03 032 131
- 10- 77 00 735 913
- 11- 77 00 733 858
- 12- 77 00 731 258
- 13- 77 00 733 912
- 14- 77 00 616 373
- 15- 77 00 634 996
- 16- 77 00 731 057
- 17- 77 05 005 104
- 18- 77 03 001 122
- 19- 77 03 053 032

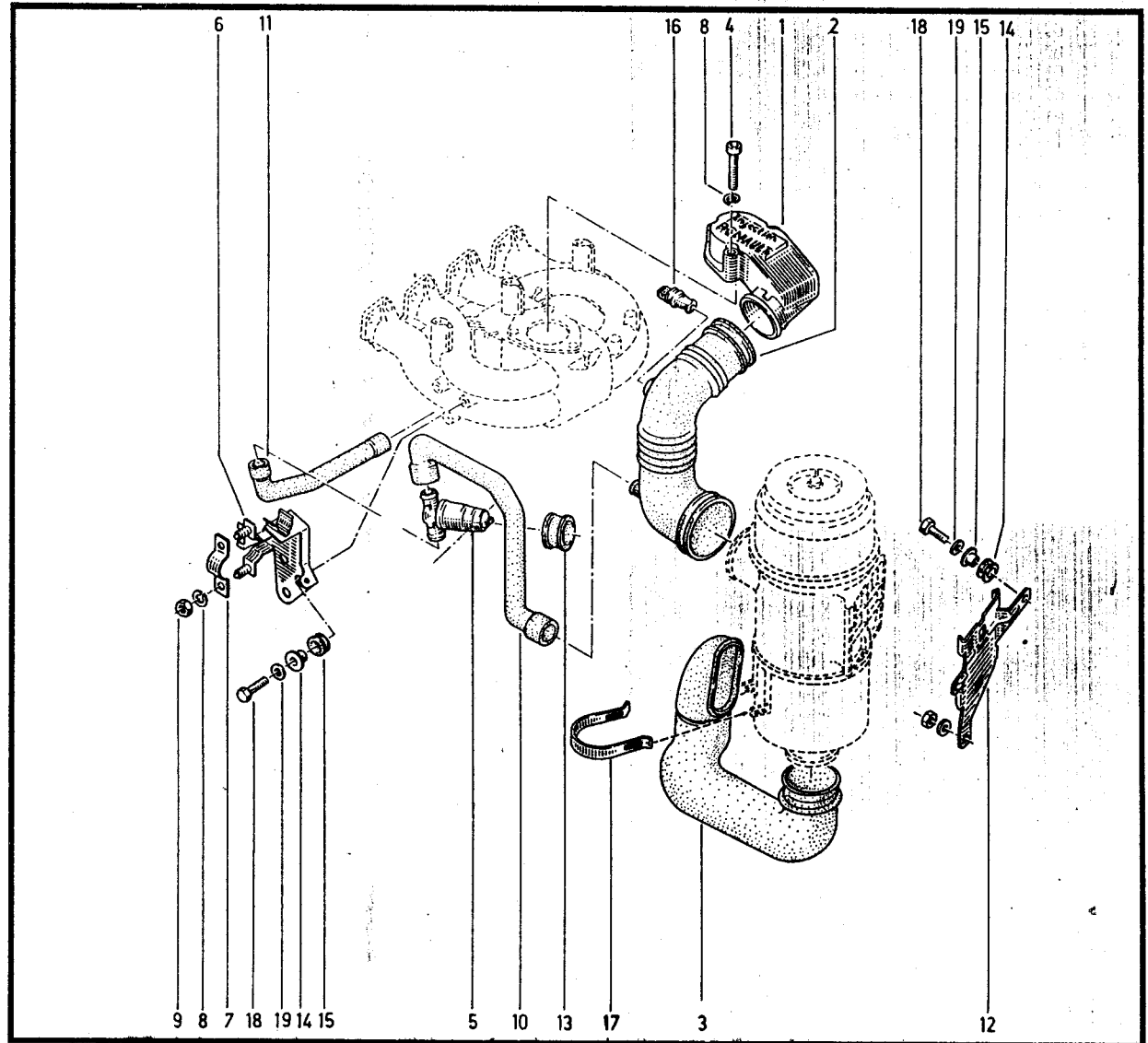

- K48Y
- L48Z
- L48Y
- K48X
- L48X
- K48G
- L48K
- L48G



14.53.5
P.R. 1233

Injection

14.53.5
P.R. 1233



- 1- 77 00 734 780
- 2- 77 00 738 229
- 3- 77 05 030 246
- 4- 77 00 735 552
- 5- 77 01 033 256
- 6- 77 03 065 119

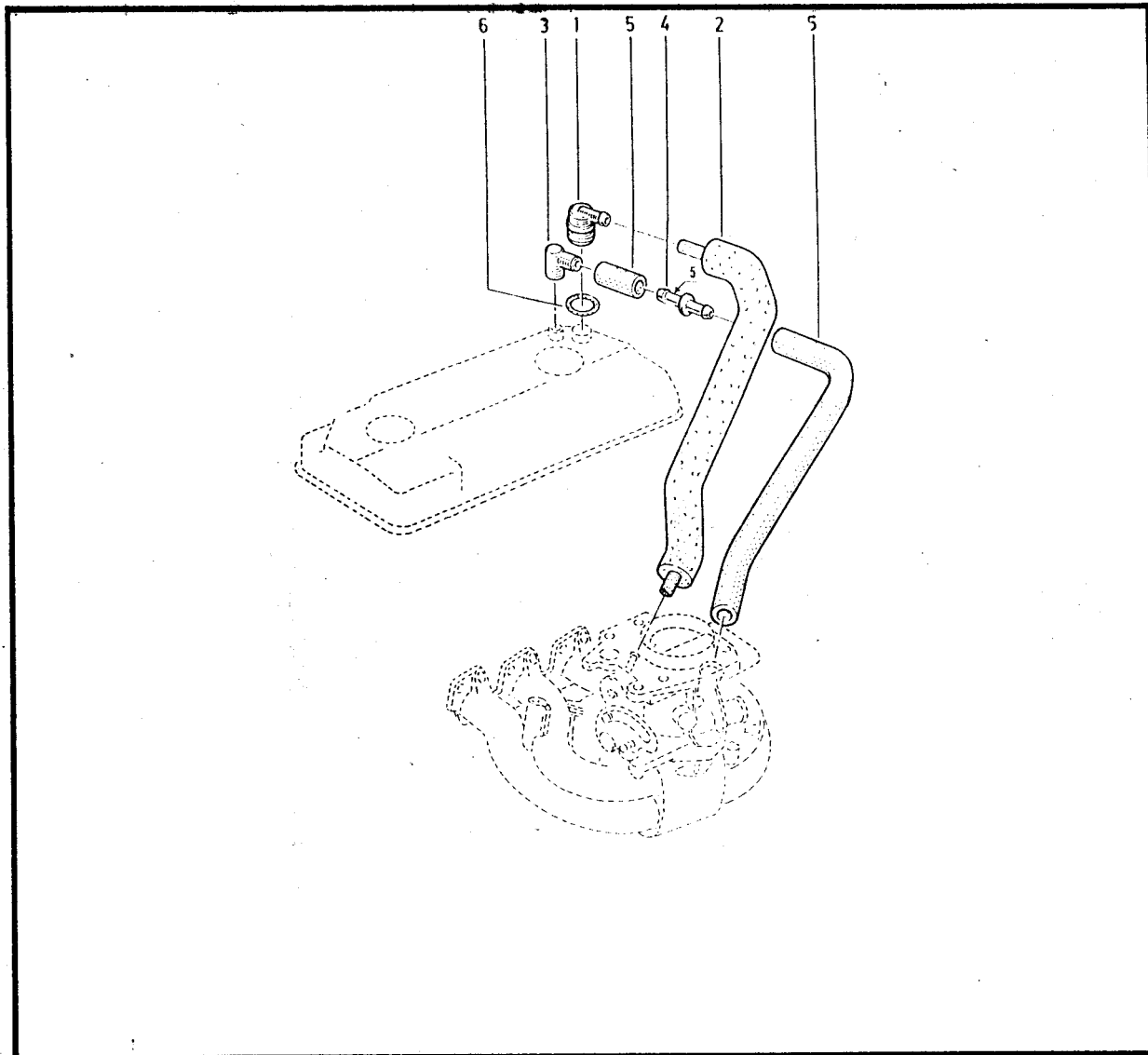

- K48Y
- L48Z
- L48Y
- K48X
- L48X
- K48G
- L48K
- L48G



14.61

P.R. 1233

14.61

P.R. 1233



- 1- 77 00 665 957
- 2- 77 02 087 176
- 3- 77 04 000 715
- 4- 77 00 776 796
- 5- 77 00 540 937
- 6- 77 02 087 184 •
- 7- 77 02 087 182 •
- 8- 77 02 087 181 •
- 9- 77 00 666 351
- 10- 77 02 057 939
- 11- 77 02 056 278
- 12- 77 02 087 183 •
- 13- 77 02 087 180 •
- 14- 77 02 087 268
- 15- 77 02 087 267
- 16- 77 02 093 639
- 17- 77 05 026 443

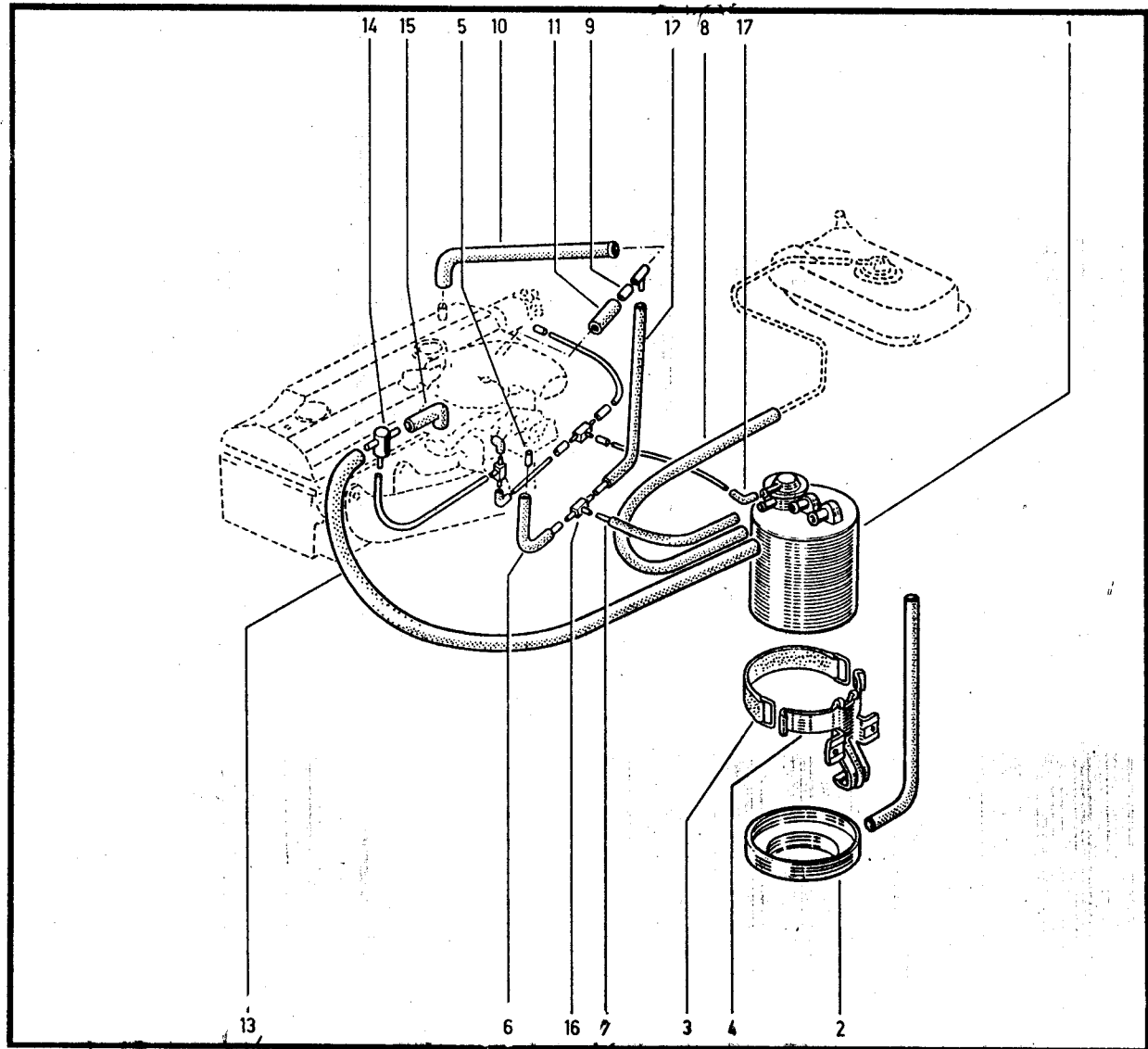

- K48S 204
- K488 202
- L488 202
- K48S 210
- L48S 208



14.61.1
P.R. 1233

Injection

14.61.1
P.R. 1233



- 1- 77 00 665 957
- 2- 77 02 087 176
- 3- 77 00 735 508
- 4- 77 03 074 105
- 5- 77 01 033 247
- 6- 77 01 349 628
- 7- 77 00 747 945
- 8- 77 01 033 227
- 9- 77 00 776 796
- 10- 77 04 000 715
- 11- 77 02 087 332

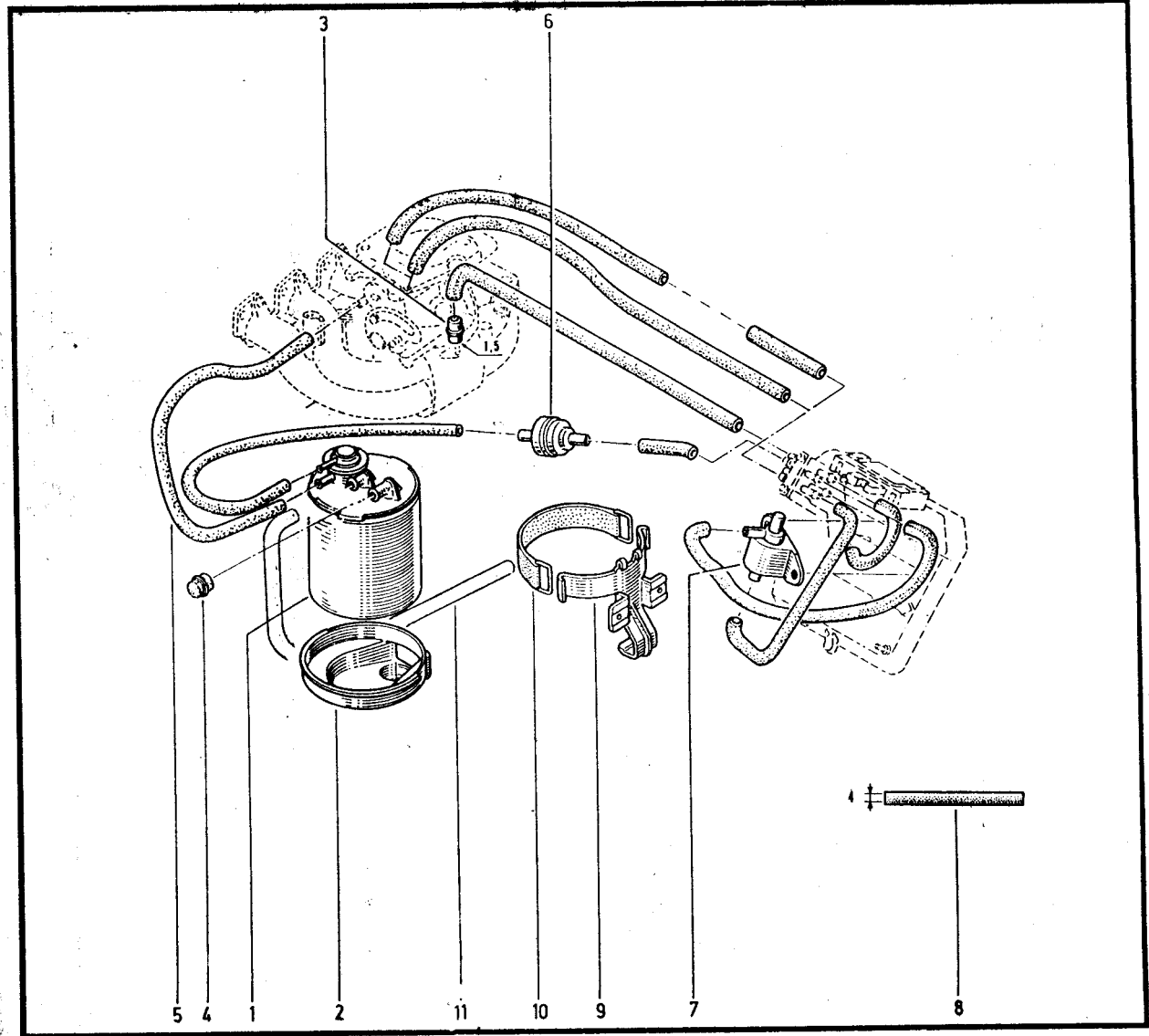

- K48X 210
- L48K 208/209
- L48X 208
- L48G 202
- K48G 202

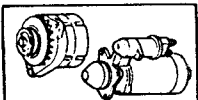

16.03

P.R. 1233

16.03

P.R. 1233

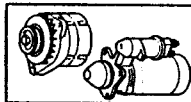

- 1- 77 00 754 850
- 77 00 796 914
- 2- 79 03 056 008
- 3- 79 03 032 009
- 4- 79 03 056 005
- 5- 79 03 032 006
- 6- 77 00 722 946
- 7- 77 03 101 072
- 8- 77 03 101 081
- 9- 79 03 056 008
- 10- 77 02 087 247
- 11- 77 03 053 550
- 12- 79 03 032 018
- 13- 77 03 058 007
- 14- 77 03 032 101
- 15- 77 02 205 105
- 77 02 205 423
- 77 02 205 333
- 16- 77 02 206 293 (x=11)
- 77 00 749 104 (a)
- 17- 77 03 100 634
- 18- 79 03 053 050
- 19- 77 02 096 229 (x=7,5)
- 77 05 010 087 (x=11)
- 20- 77 00 723 818
- 21- 77 03 001 162
- 22- 77 03 053 037
- 23- 77 03 055 011

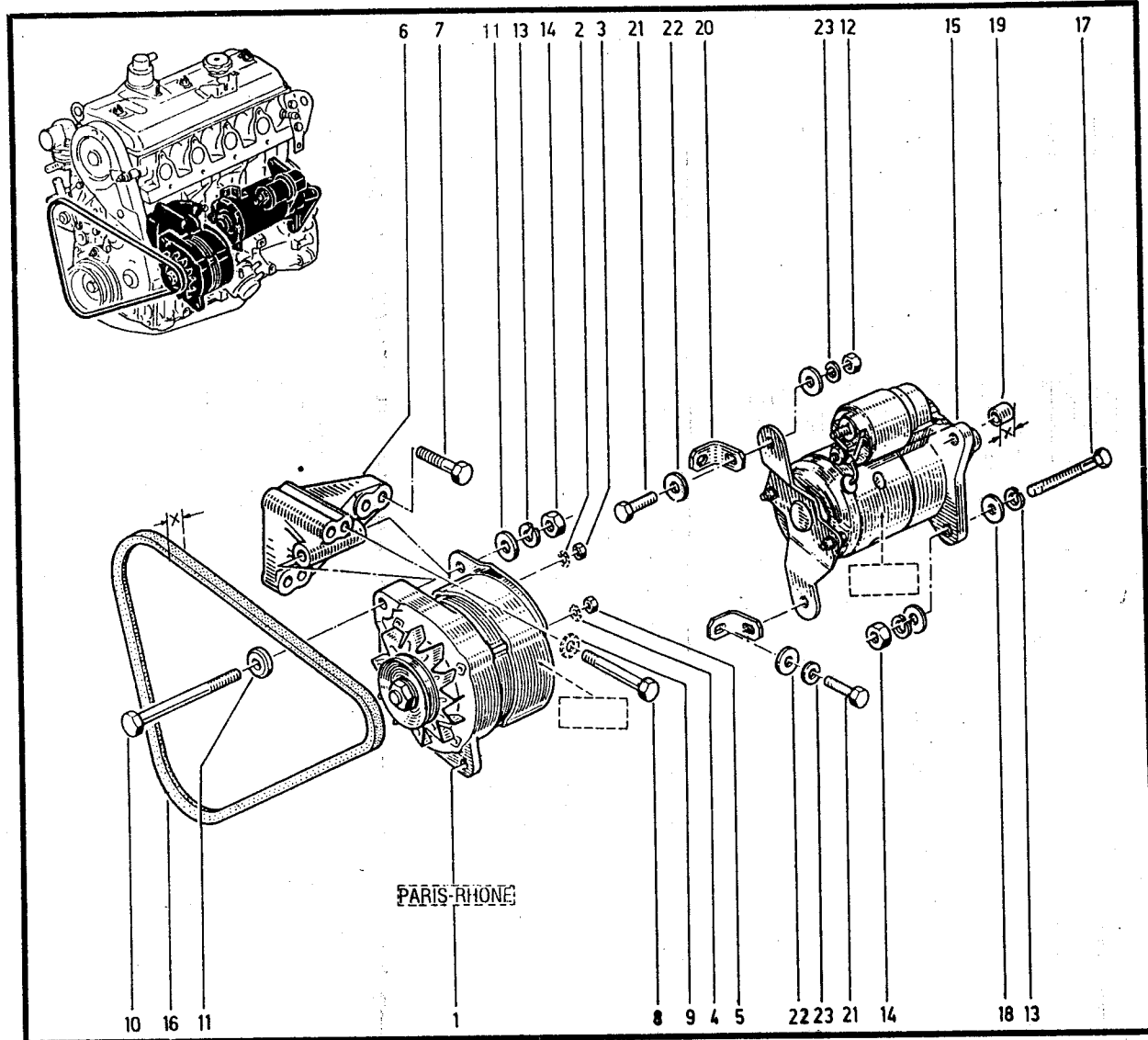

- | | |
|-----|----------|
| | K48G 202 |
| | L48G 202 |
| | L48K 209 |
| (a) | K48X 210 |
| | L48K 208 |
| | L48X 208 |
| | L48Z 091 |

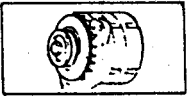

16.05

P.R. 1233

PARIS-RHONE

16.05

P.R. 1233

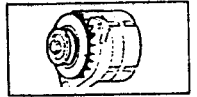

- 1- 77 00 754 850
- 2- 77 01 030 809
- 3- 77 01 030 810 (1)
- 77 01 034 074 (2)
- 4- 77 01 030 811
- 5- 77 01 030 813
- 6- 77 01 031 089 (1)
- 77 01 034 178 (2)
- 7- 77 01 030 815
- 8- 77 01 030 258
- 9- 77 01 030 000
- 10- 77 01 030 817
- 11- 77 00 796 914

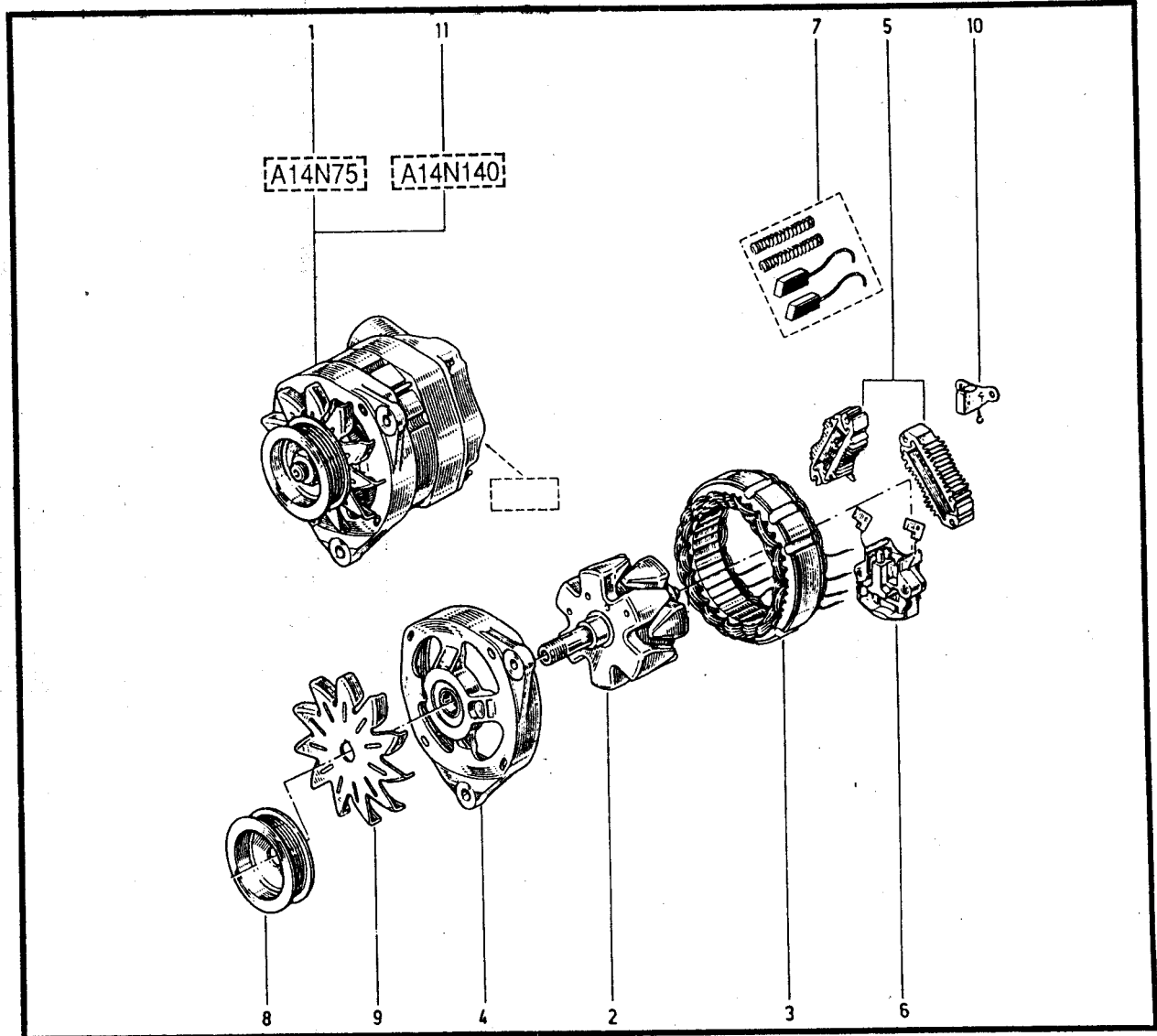

- (1) 7700754850
- (2) 7700796914

16.47.9

P.R. 1233

VALEO

16.47.9

P.R. 1233



- 1 - 77 00 808 647
- 2 - 77 01 203 874
- 3 - 77 01 203 877
- 4 - 77 01 203 873
- 5 - 77 01 203 878
- 6 - 77 01 203 879

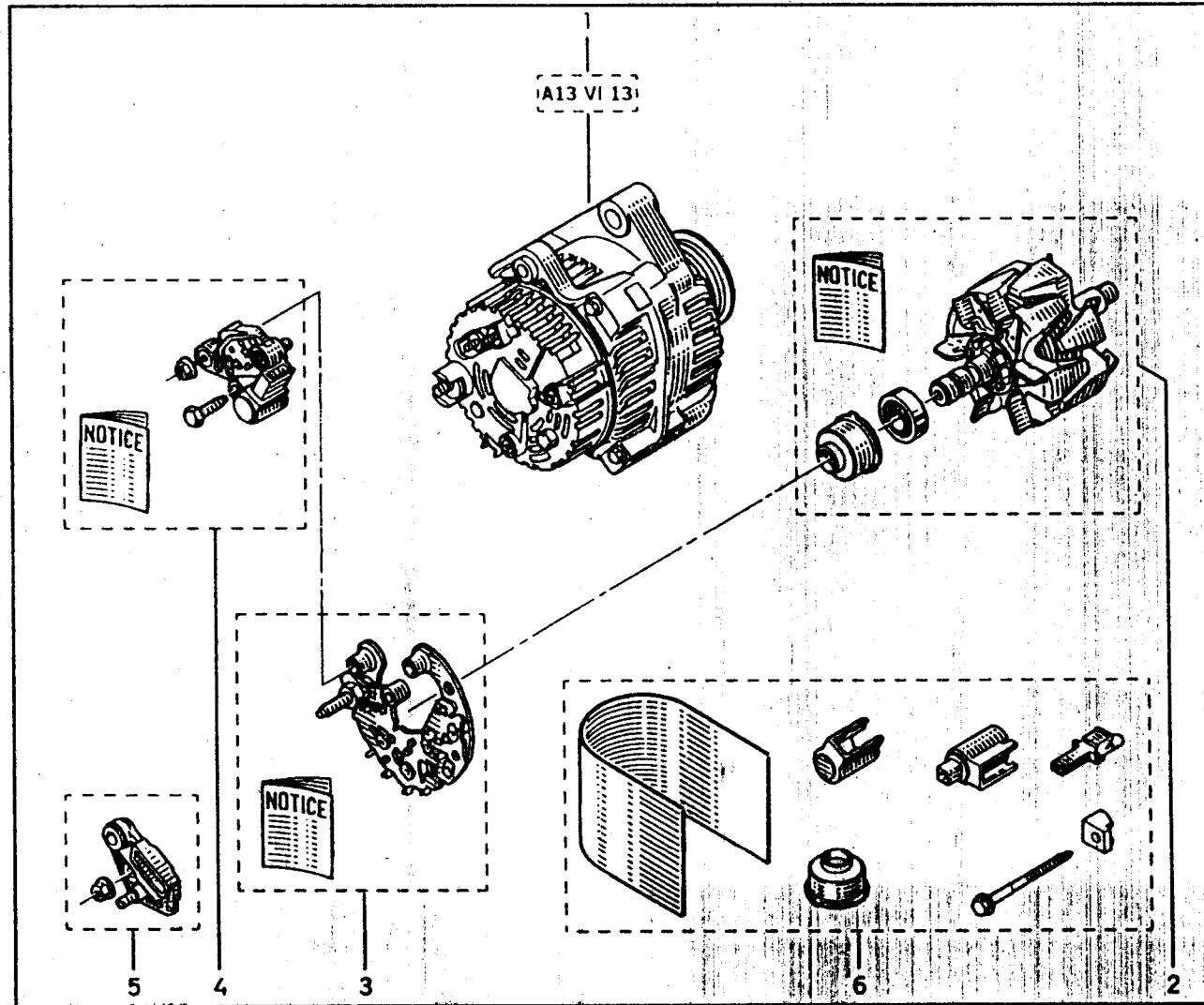



16.70

P.R. 1233

16.70

P.R. 1233

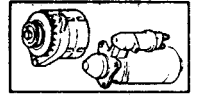

- 1 - 77 02 073 963
- 2 - 77 02 088 726
- 3 - 77 02 073 953
- 4 - 77 02 073 954
- 5 - 77 02 073 955
- 6 - 77 02 073 887
- 7 - 77 02 073 957
- 8 - 77 02 073 958
- 9 - 77 02 073 959
- 10 - 77 02 089 393
- 11 - 77 02 073 961
- 12 - 77 02 073 962
- 13 - 77 02 073 964
- 14 - 77 02 073 965
- 15 - 77 02 073 966
- 16 - 77 02 088 723
- 17 - 77 02 073 968
- 18 - 1017328
- 19 - 77 02 073 969
- 20 - 77 02 073 970
- 21 - 77 02 089 399
- 22 - 77 02 073 972
- 23 - 77 02 073 973
- 24 - 77 02 073 974
- 25 - 77 02 073 975
- 26 - 77 02 073 976
- 27 - 77 02 073 977
- 28 - 77 02 073 978
- 29 - 77 03 055 005
- 30 - 77 02 206 099
- 31 - 77 02 073 980
- 32 - 77 03 055 011
- 33 - 79 03 032 072
- 34 - 77 02 205 105
- 35 - 77 02 206 100

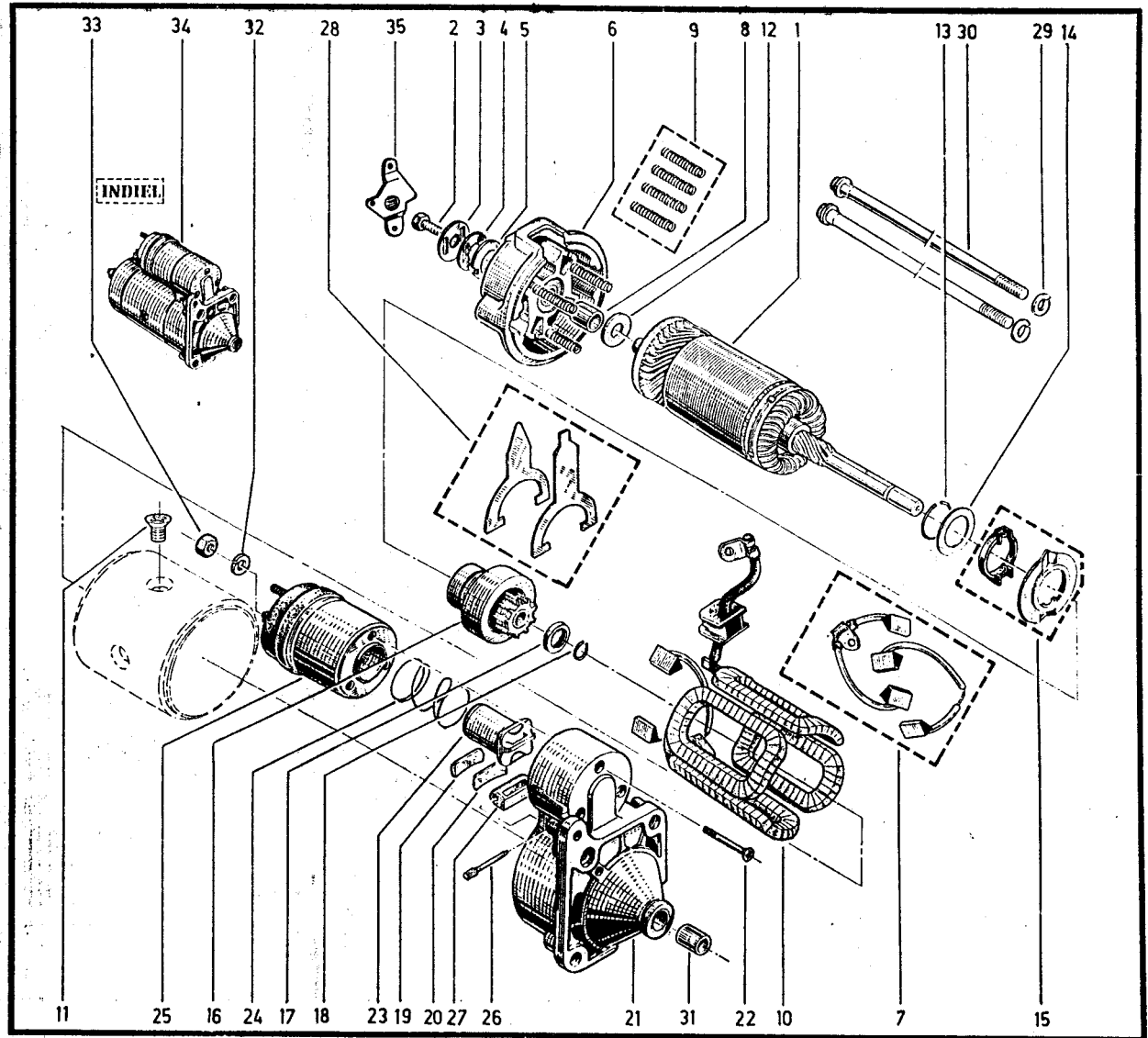

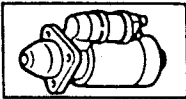

16.75

P.R. 1233

- 1-77 02 205 333
- 2-77 02 206 633
- 3-77 02 206 635
- 4-77 02 206 656
- 5-77 02 206 640
- 6-77 02 206 641
- 7-77 02 206 644
- 8-77 02 206 645
- 9-77 02 206 647
- 10-77 02 206 655
- 11-77 02 206 651
- 12-77 02 206 654

16.75

P.R. 1233

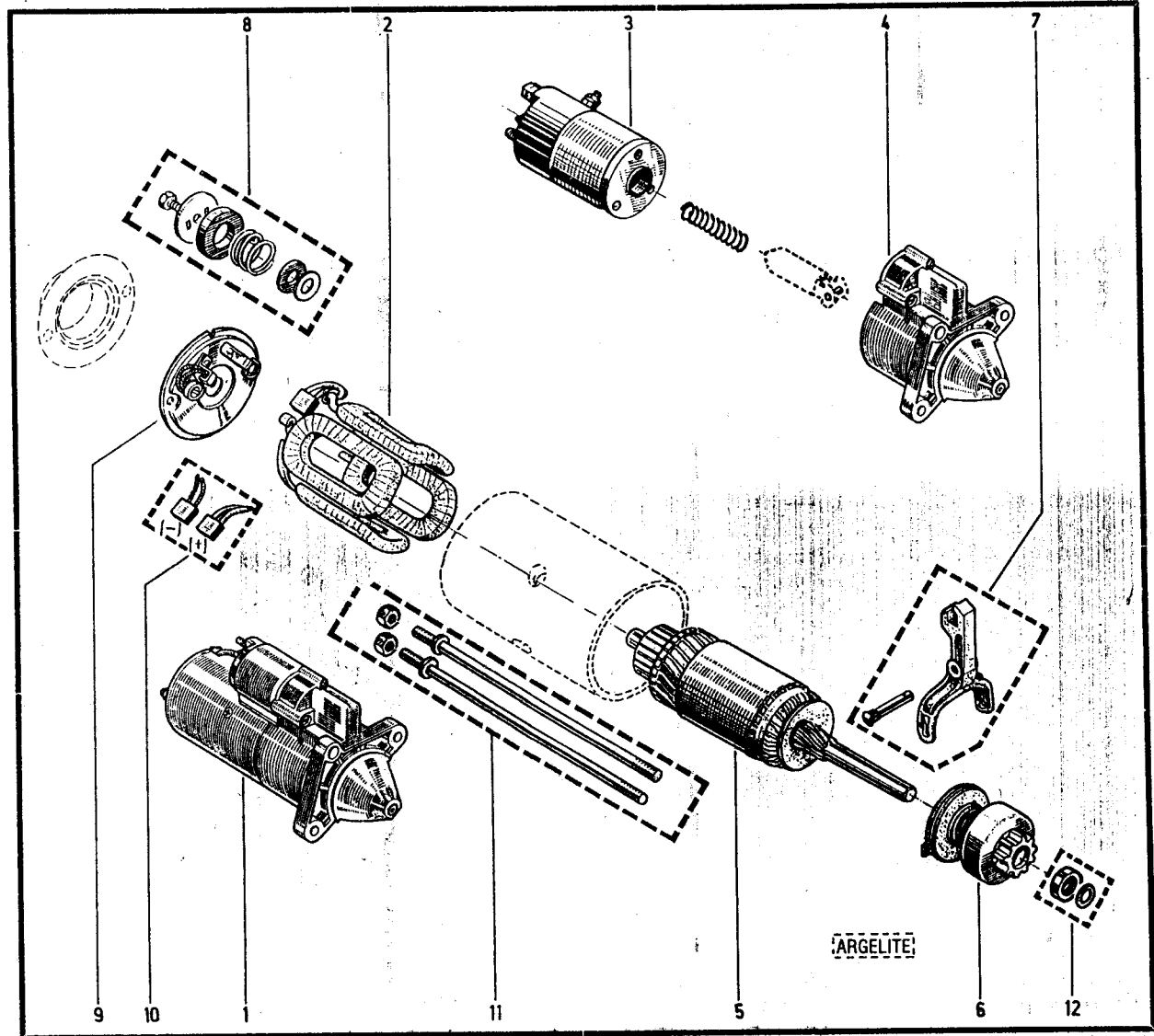

7702205333 (300000005)



16.76

P.R. 1233

16.76

P.R. 1233



- 1-77 02 217 126
- 2-77 02 217 128
- 3-77 02 217 130
- 4-77 02 217 131
- 5-77 02 217 132
- 6-77 02 217 133
- 7-77 02 217 134
- 8-77 02 217 135
- 9-77 02 217 136
- 10-77 02 217 137
- 11-77 02 217 138
- 12-77 02 217 139
- 13-77 02 217 140
- 14-77 02 217 142
- 15-77 02 205 423
- 16-77 02 207 143

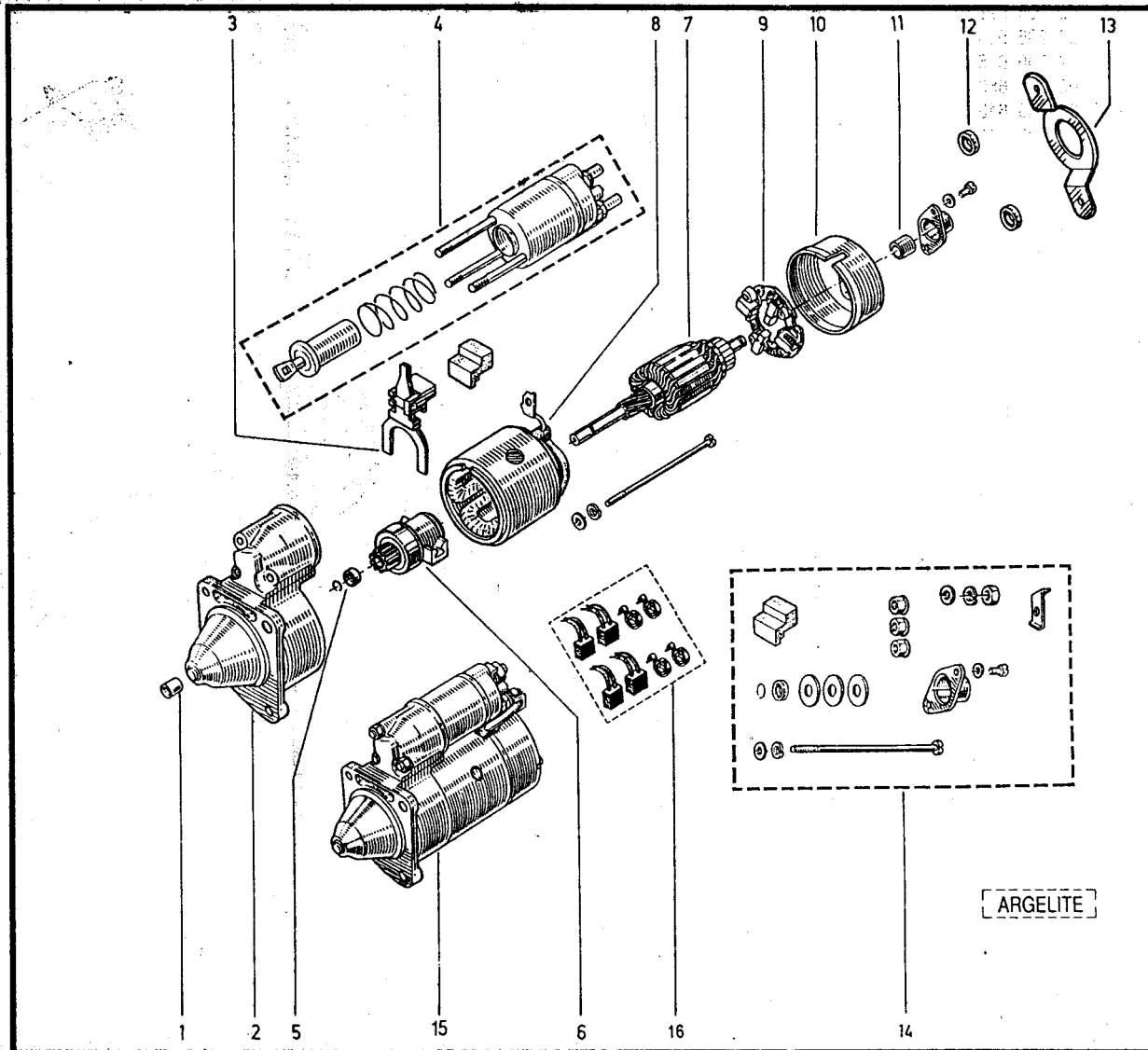

7702205423 (30000013)

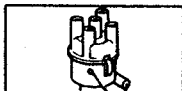

17.01.1

P.R. 1233

Injection

17.01.1

P.R. 1233



- 1- 77 00 730 116
- 2- 77 03 065 082
- 3- 79 03 057 013
- 4- 77 03 009 005
- 5- 77 01 202 683

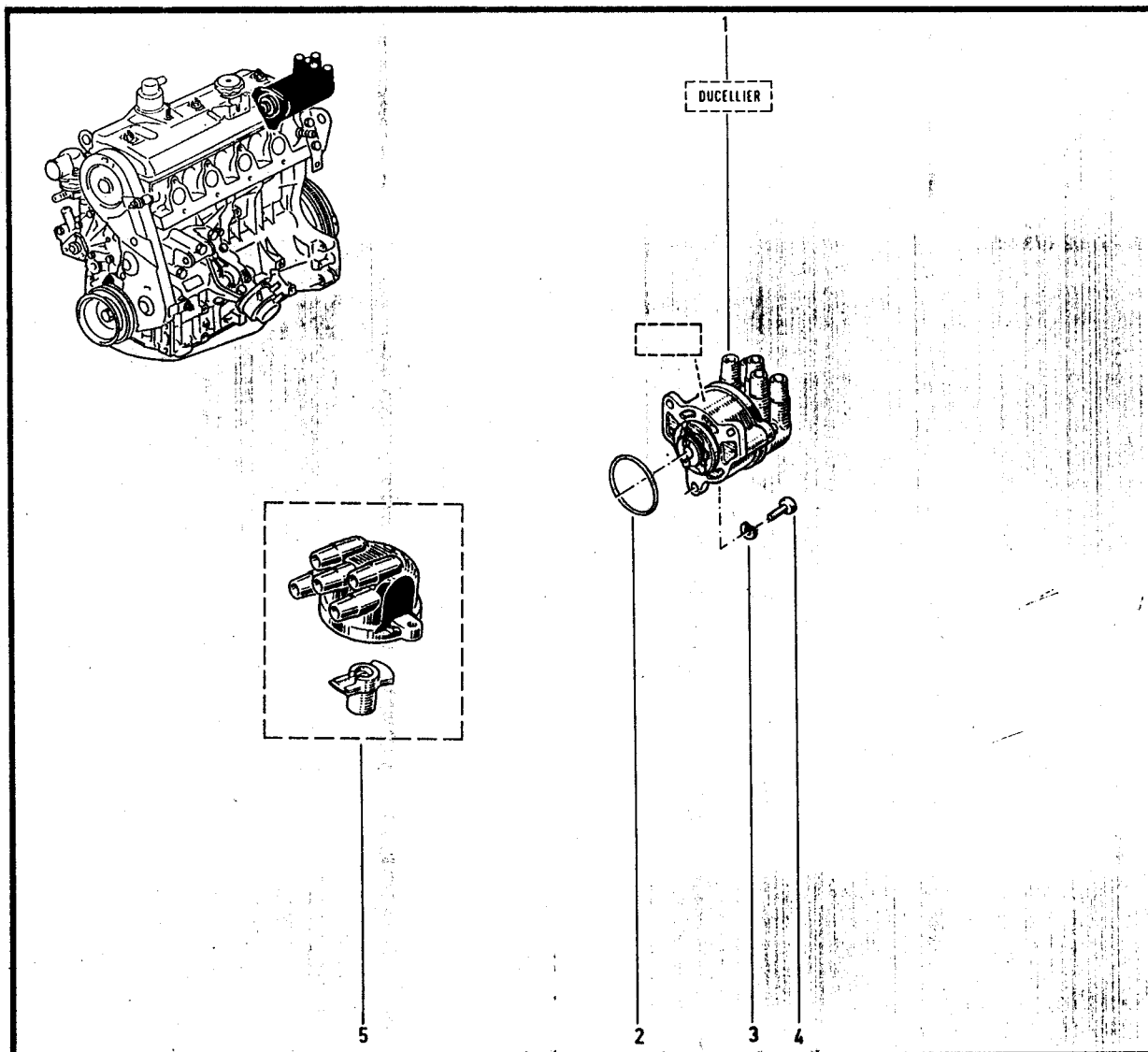

- K48Y
- L48Z
- L48Y
- K48X
- L48X
- K48G
- L48K
- L48G



17.04

P.R. 1233

17.04

P.R. 1233



- 1- 77 02 205 411 (b)
- 77 02 206 613 (a)
- 2- 77 02 205 332
- 3- 77 02 073 158
- 4- 02 24 827 100
- 5- 77 02 206 619
- 6- 77 02 206 618
- 7- 77 02 073 163
- 8- 77 02 206 615
- 9- 77 02 073 202
- 0- 77 02 073 154

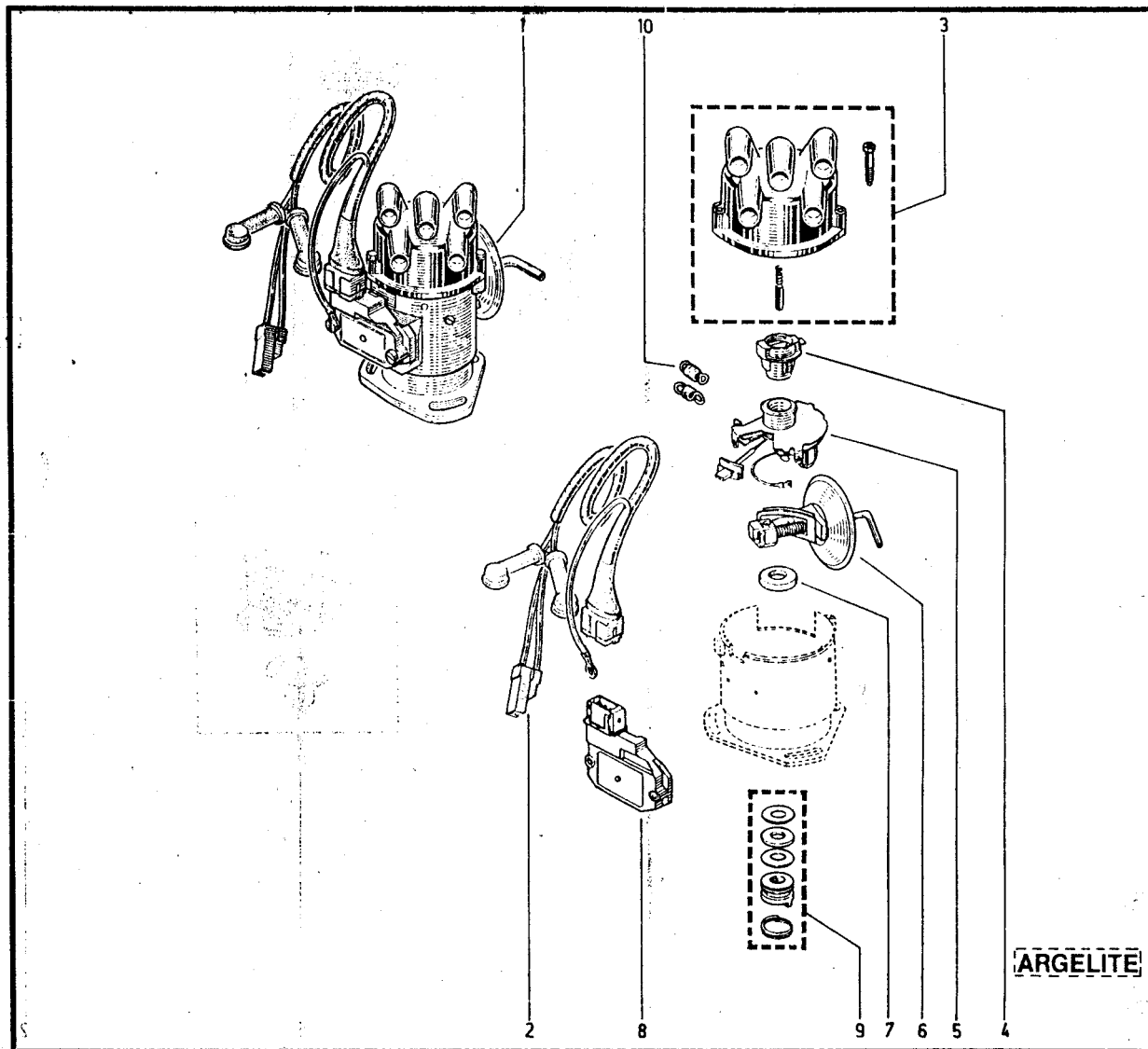

	K48S 090	K48S 204
	K488 089	K488 202
	L48S-091	(b) L488 202
(a)	K48S 092	K48S 210
	L488 089	L48S 208

17.05

P.R. 1233

- 1 - 77 02 205 452
- 2 - 77 02 217 305
- 3 - 77 02 217 346
- 4 - 77 02 217 309
- 5 - 77 02 217 345
- 6 - 77 02 217 307
- 7 - 77 02 217 344
- 8 - 77 02 217 308
- 9 - 77 02 217 306
- 10 - 77 02 217 347
- 11 - 77 02 217 348
- 12 - 77 02 217 350
- 13 - 77 02 217 311
- 14 - 77 02 217 312
- 15 - 77 02 217 310

(a)

17.05

P.R. 1233

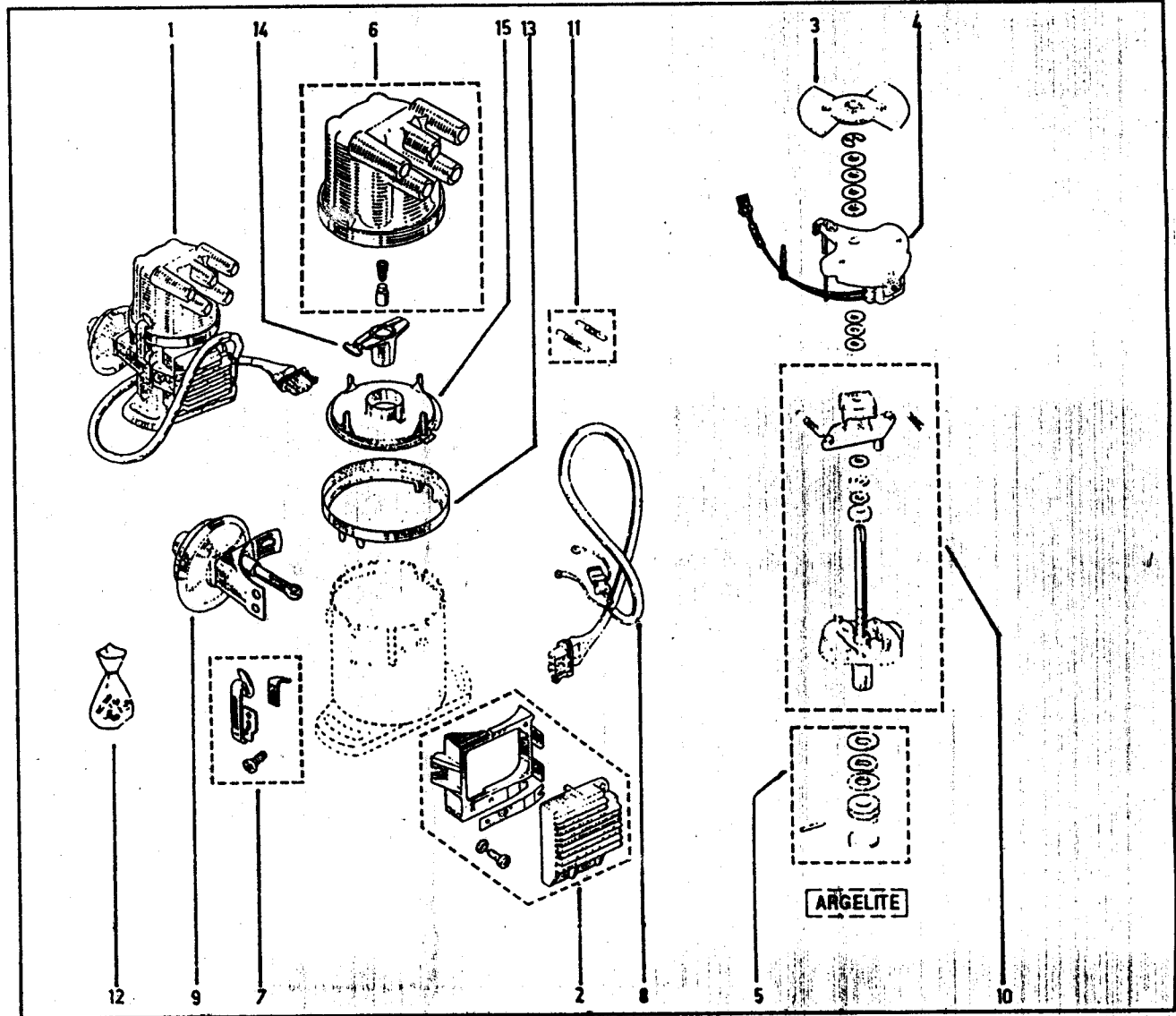

(a) / L48S 090	n° 16696	→ n°
K487 069	n° 59	→ n°



17.10

EST. R.4

17.10

P.R. 1233



- 1-77 02 206 318 (1)
- 2-77 03 053 033
- 3-79 03 056 037
- 4-79 03 032 009

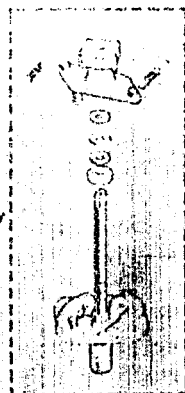
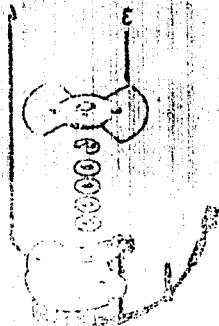

ANGELTE

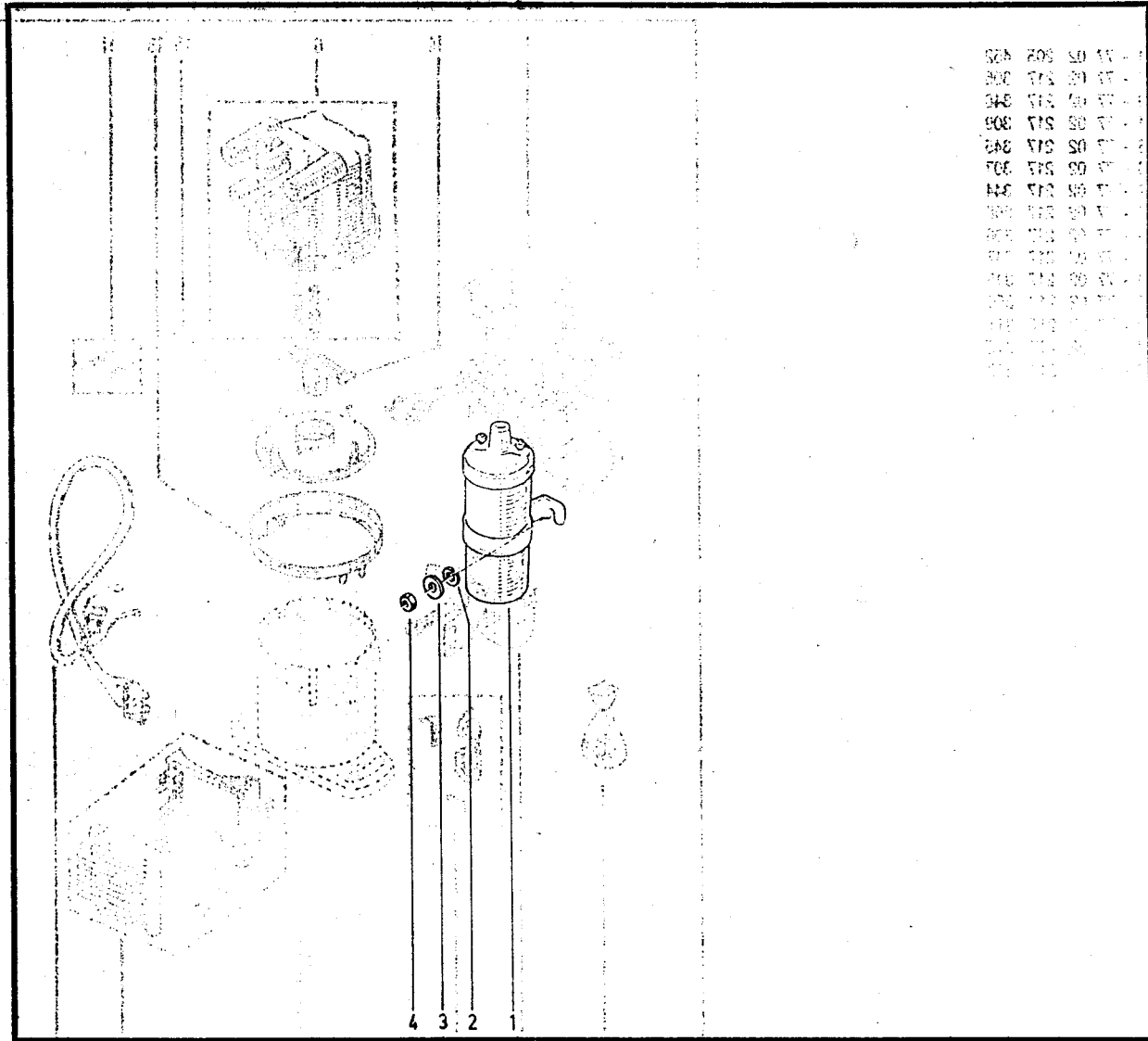

50A	206	318	1
50B	053	033	2
50C	056	037	3
50D	032	009	4
50E	056	037	5
50F	056	037	6
50G	056	037	7
50H	056	037	8
50I	056	037	9
50J	056	037	10
50K	056	037	11
50L	056	037	12
50M	056	037	13
50N	056	037	14
50O	056	037	15
50P	056	037	16
50Q	056	037	17
50R	056	037	18
50S	056	037	19
50T	056	037	20

50A	206	318	1
50B	053	033	2
50C	056	037	3
50D	032	009	4

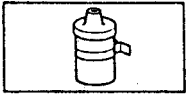

17.14.1
P.R. 1233

Injection

17.14.1
P.R. 1233



- 1- 77 00 852 662 (A)
- 77 00 852 093 (B)
- 2- 77 01 031 135
- 3- 77 03 033 025
- 4- 77 03 053 067
- 5- 77 00 735 564
- 77 00 866 055
- 6- 77 00 739 793
- 7- 77 05 001 094
- 8- 79 03 056 046
- 9- 77 03 050 116

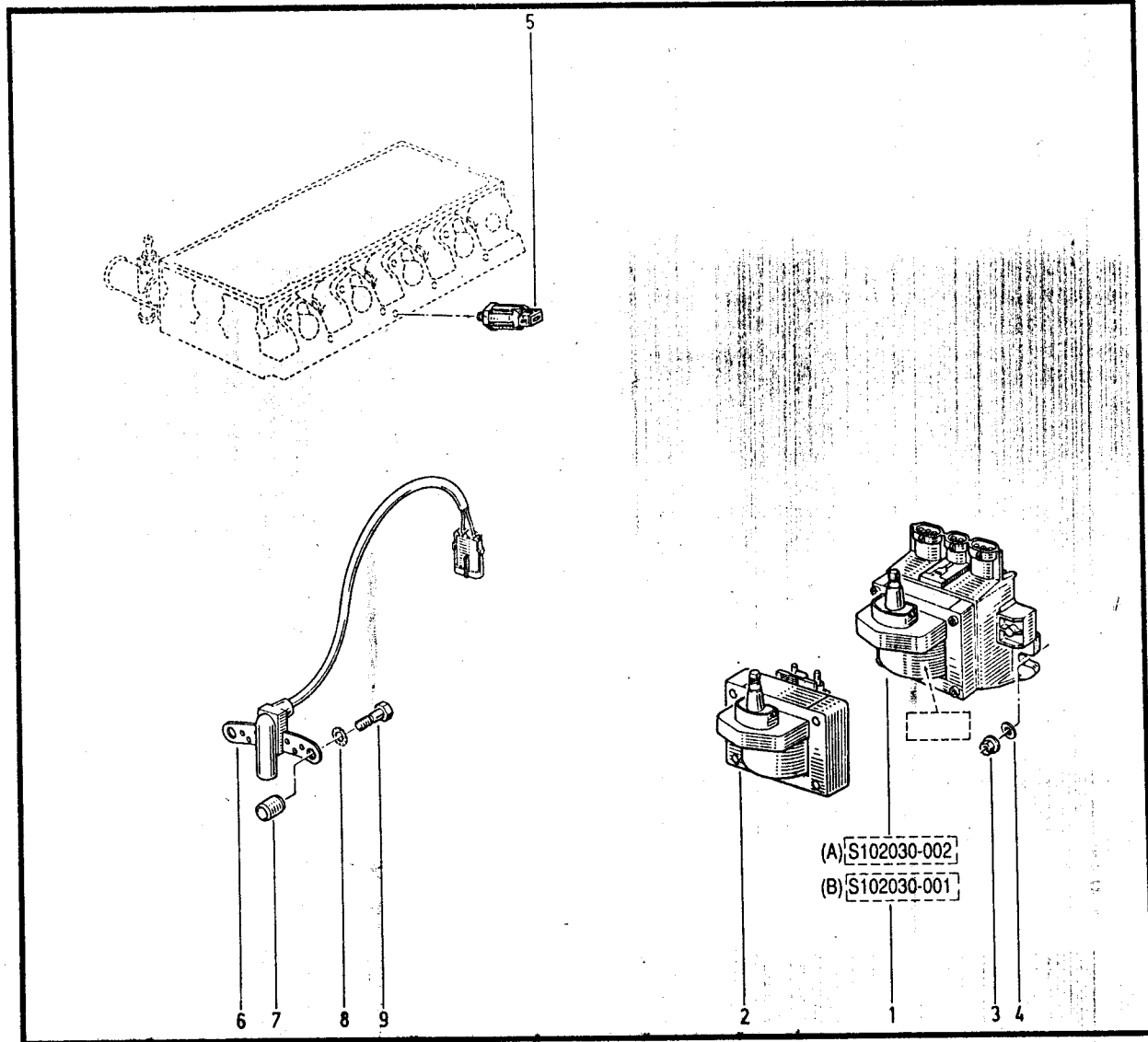

- K48Y
- L48Z
- L48Y
- K48X
- L48X
- K48G
- L48K
- L48G

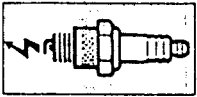

17.20
P.R. 1233

- 1- 77 00 736 150
- 2- 77 02 089 419
- 3- 77 02 206 704
- 4- 77 02 206 703

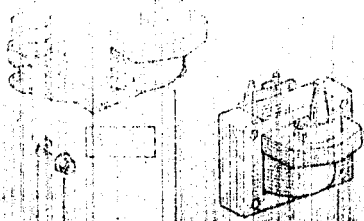

500-0605012 (A)
17 (A) 2105050-005

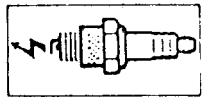

17.20
P.R. 1233

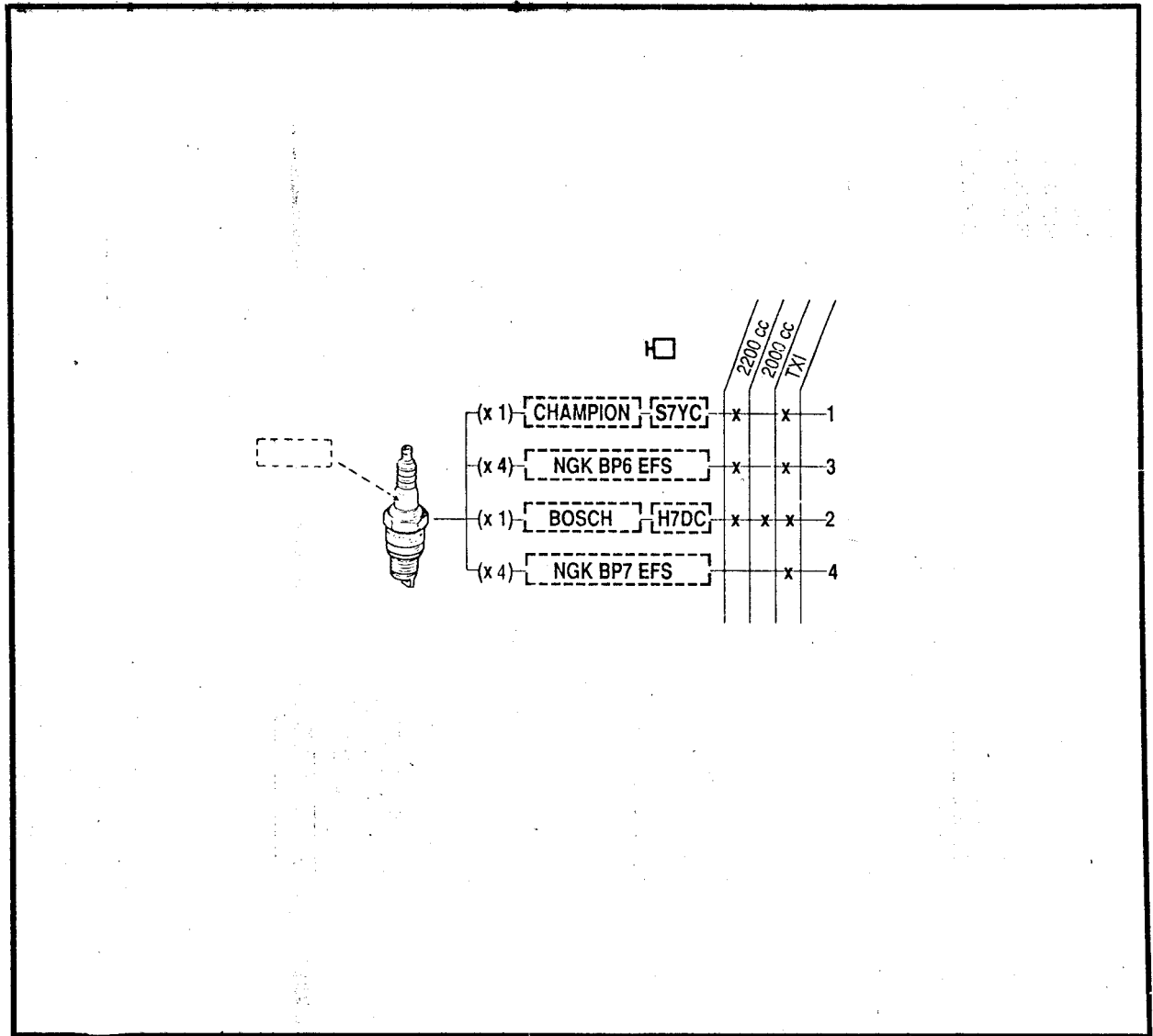



17.30

P.R. 1233

- 1- 77 02 099 543
- 2- 77 02 205 164
- 3- 77 00 649 095
- 4- 77 00 864 332
- 5- 77 00 742 038
- 6- 77 03 053 642
- 7- 77 03 001 236

17.30

P.R. 1233

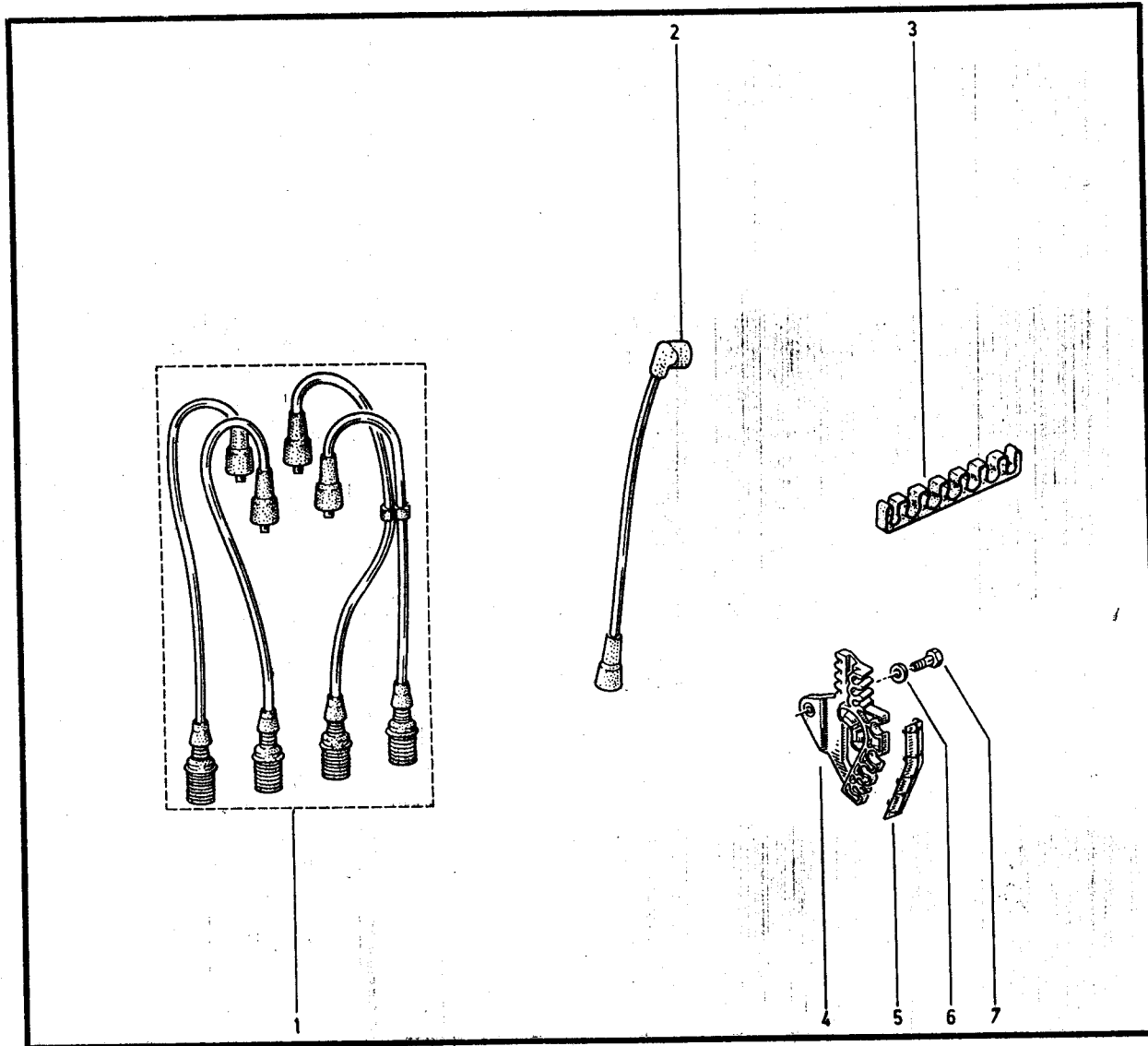



17.30.1
P.R. 1233

Injection

17.30.1
P.R. 1233



- 1- 77 00 734 170
- 2- 77 00 733 139
- 77 00 850 456 (ABS)
- 3- 77 00 637 724
- 77 00 591 693 (ABS)

77 00 734 170
77 00 733 139
77 00 850 456
77 00 637 724
77 00 591 693

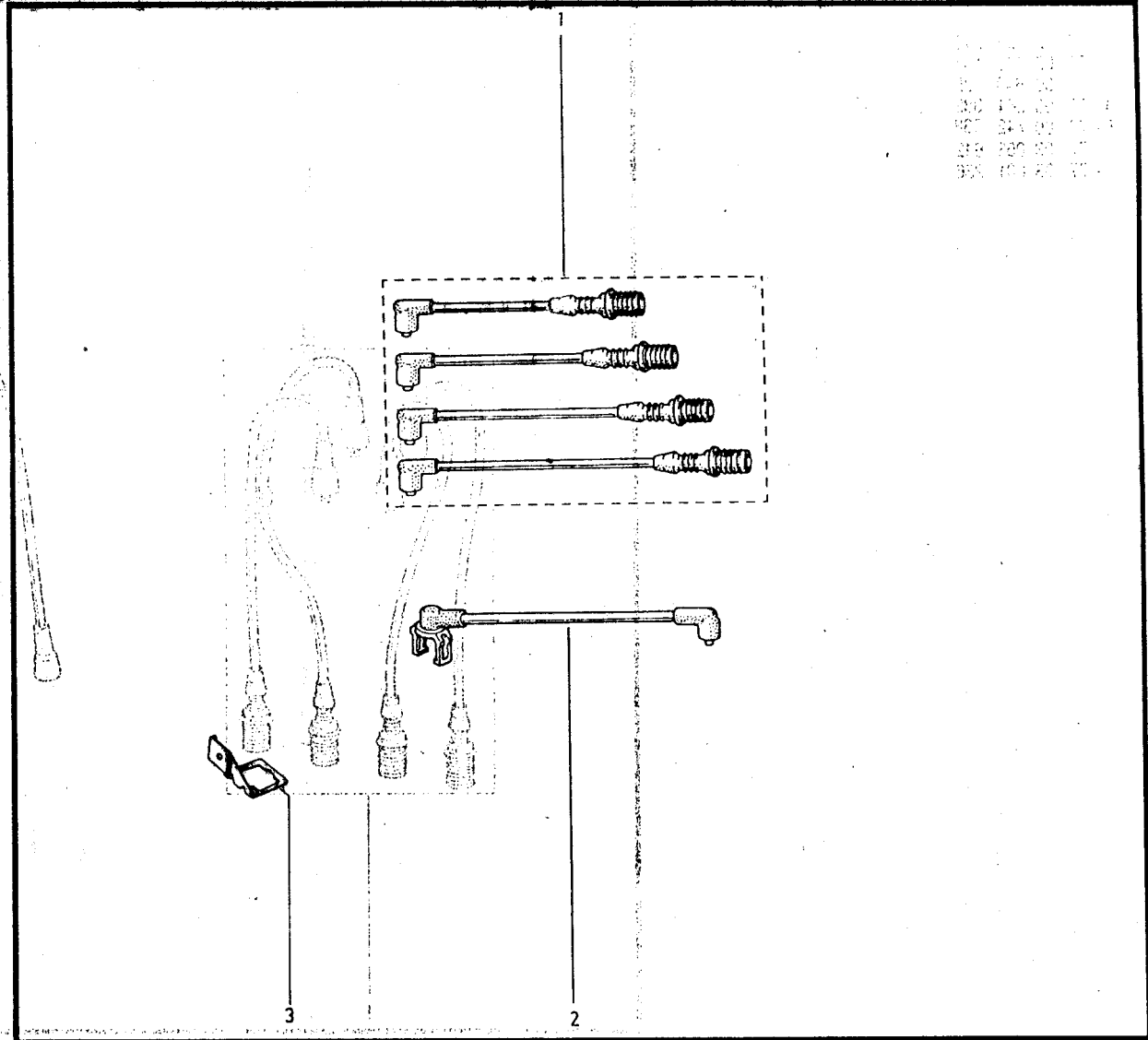



17.40.1
P.R. 1233

Injection

17.40.1
P.R. 1233



- 1- 77 00 766 653
- 2- 77 02 205 421
- 3- 77 00 706 876
- 4- 77 01 332 227 ✂ 1m
- 5- 77 00 735 508
- 6- 77 00 722 068
- 7- 77 00 766 652
- 8- 77 00 774 721
- 9- 77 00 756 460
- 10- 77 00 766 654
- 11- 77 03 041 018
- 12- 77 00 783 222

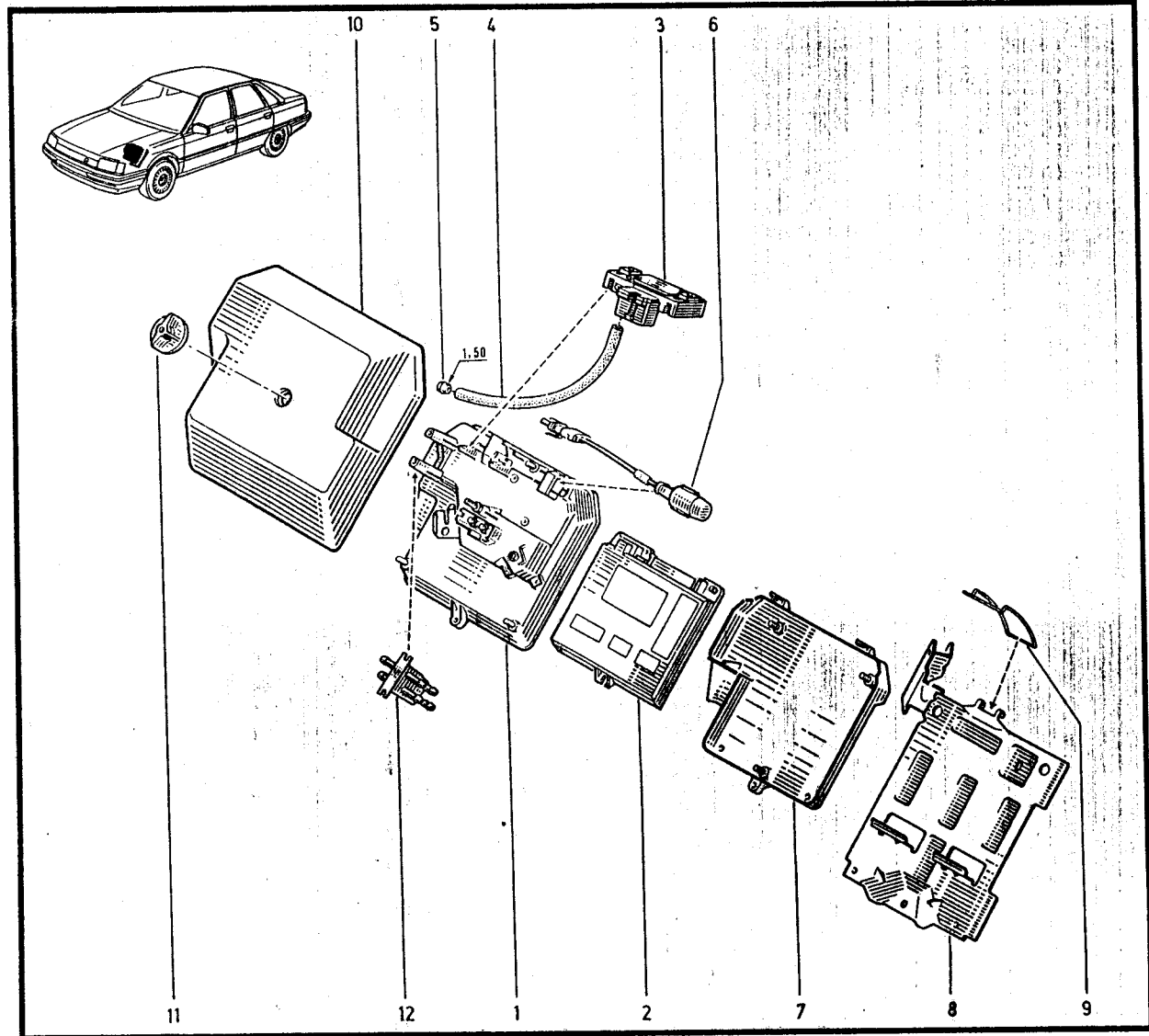

K48Y 092 / 090
L48Z 091 / 095
L48Y 091



17.40.2

P.R. 1233

17.40.2

P.R. 1233



Injection

- 1- 77 00 766 653
- 2- 77 02 205 422
- 3- 77 00 706 876
- 4- 77 01 332 227 $\times 1m$
- 5- 77 00 735 508
- 6- 77 00 722 068
- 7- 77 00 766 652
- 8- 77 00 774 721
- 9- 77 00 756 460
- 10- 77 00 766 654
- 11- 77 03 041 018
- 12- 77 00 783 222

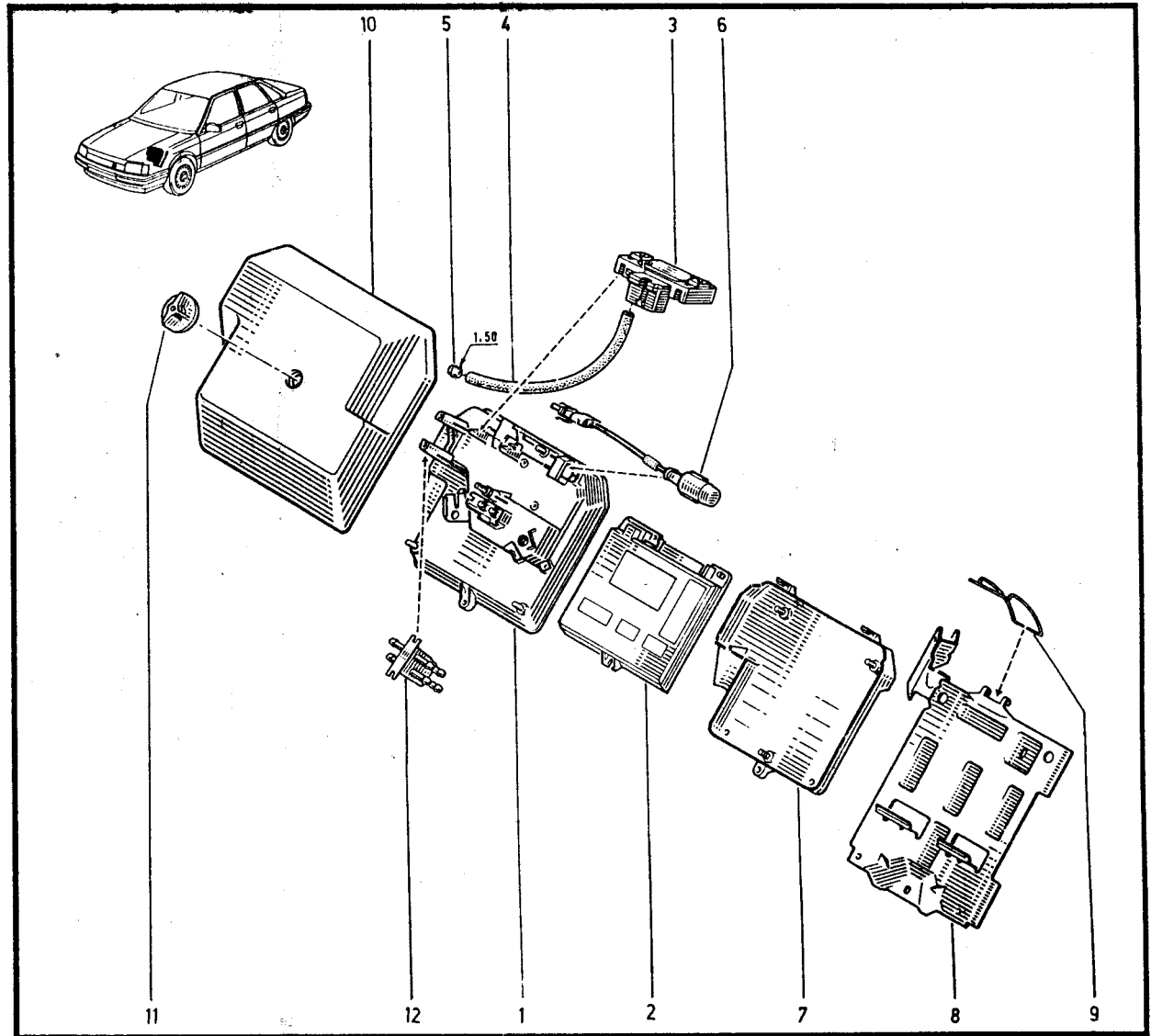

- K48X 210
- L48K 208/209
- L48X 208
- L48G 202
- K48G 202

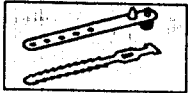

17.51.1

P.R. 1233

- 1- 77 00 717 999
- 2- 77 00 768 057
- 3- 77 00 864 382
- 4- 77 03 001 236
- 5- 77 03 053 642
- 6- 77 00 742 038

Injection

17.51.1

P.R. 1233

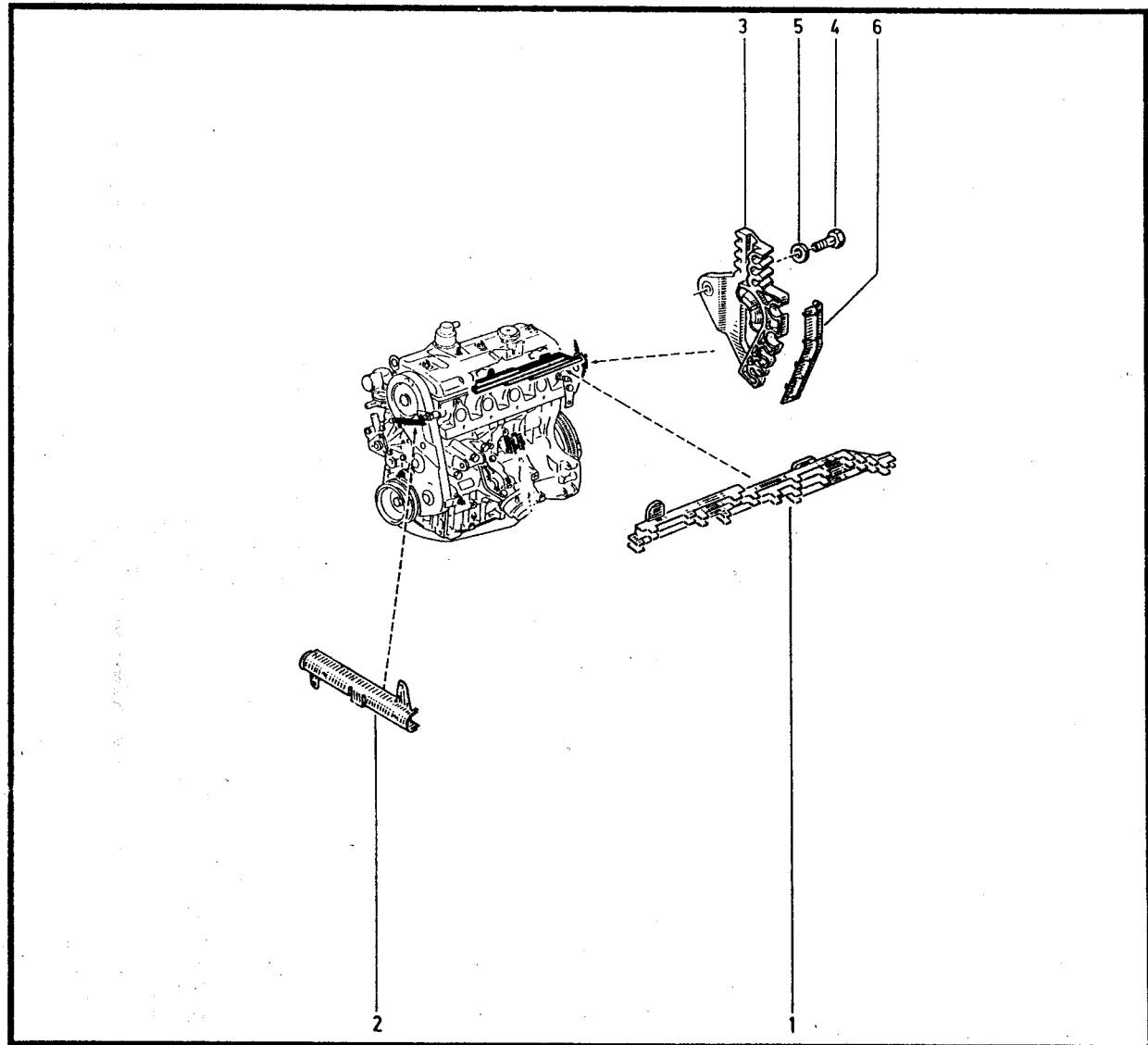
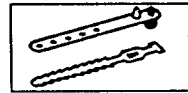

- K48Y
- L48Z
- L48Y
- K48X
- L48X
- K48G
- L48K
- L48G



18.06

P.R. 1233

18.06

P.R. 1233



- 1- 77 02 099 349
- 2- 77 02 093 639
- 3- 77 02 086 422 (a)
- 77 02 086 982 (b)
- 4- 77 02 086 421 (a)
- 77 02 086 641 (b)
- 5- 77 02 085 058 \times 1m
- 6- 77 02 205 311 (b)
- 7- 77 02 086 985 (b)

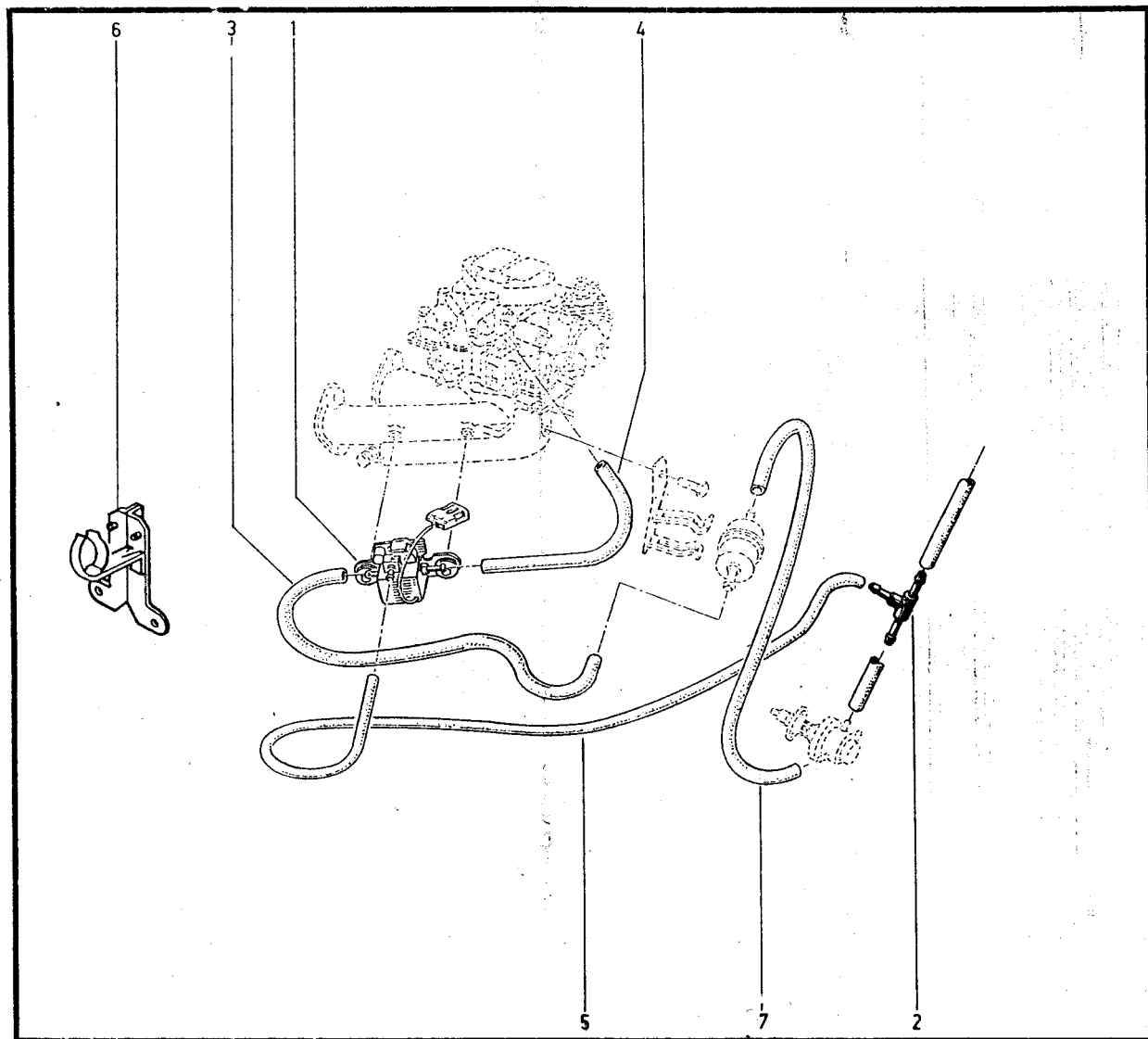

(a)	L48S	n° 1	→	n° 4963
	K48S	n° 1	→	n° 0618
(b)	L48S	n° 4964	→	n°
	K48S	n° 0619	→	n°



18.07

P.R. 1233

- 1- 77 02 087 411
- 2- 77 02 086 761
- 3- 77 02 085 057 $\times < 1m$
- 4- 77 02 087 019
- 5- 77 02 057 176

18.07

P.R. 1233

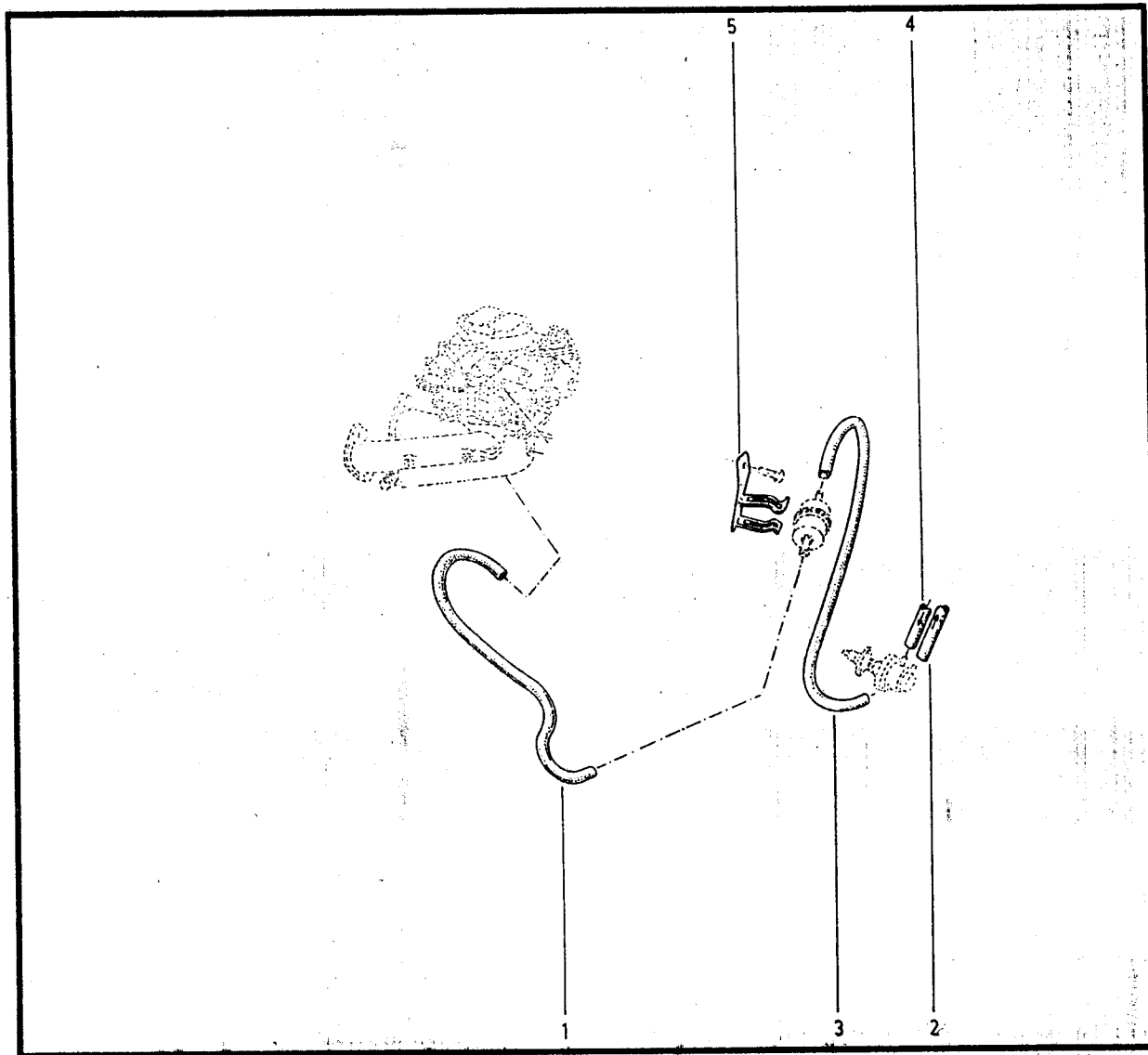

K487 089
L488 089
K488 089

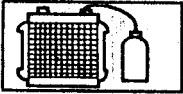

19.01

P.R. 1233

- 1- 77 02 094 708
- 2- 77 00 683 146
- 3- 77 00 763 644
- 4- 77 00 770 982
- 5- 77 00 780 081
- 6- 77 02 205 100
- 7- 77 03 001 122
- 8- 79 03 053 028
- 9- 77 03 055 007
- 10- 79 03 032 009

19.01

P.R. 1233

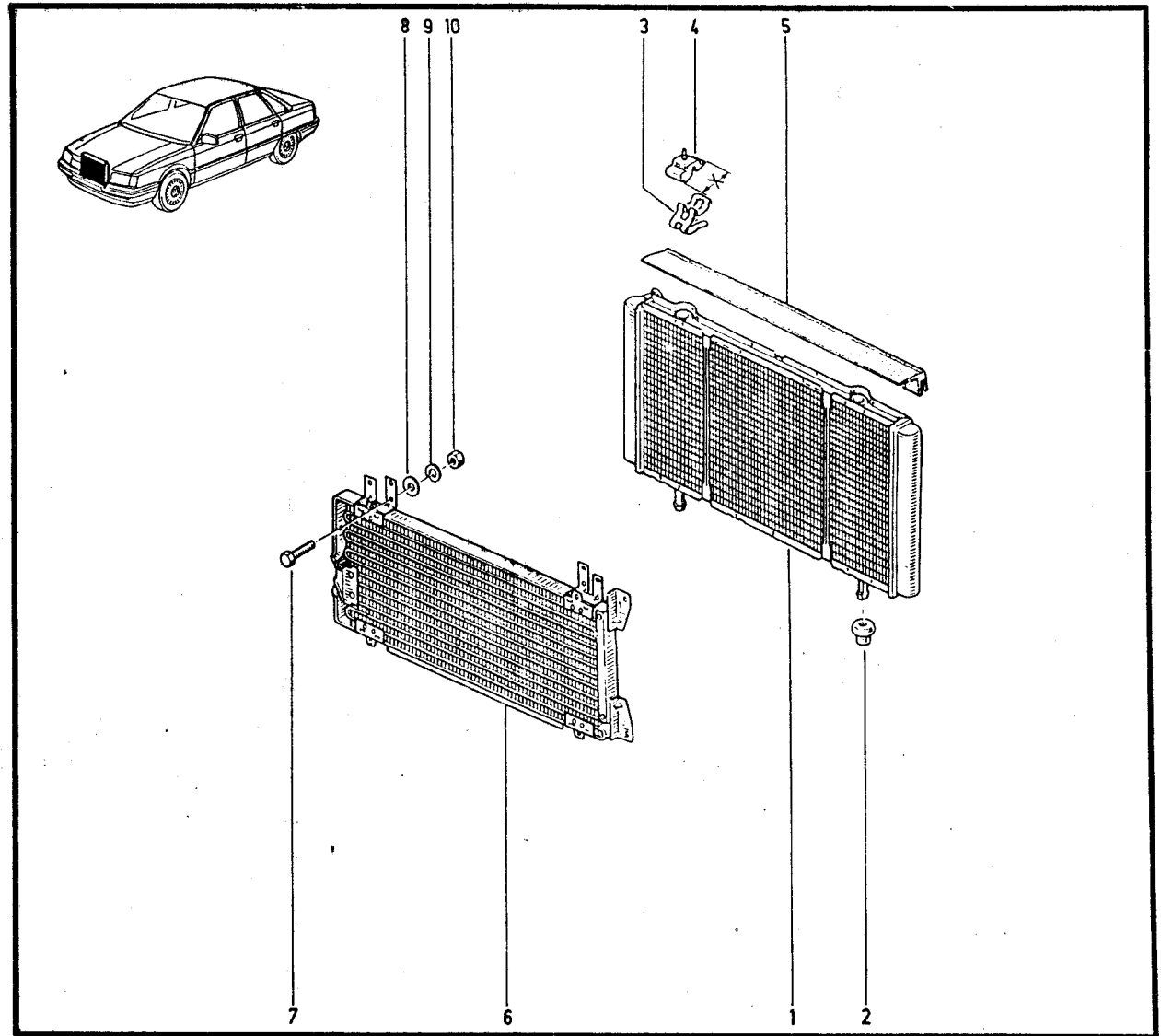
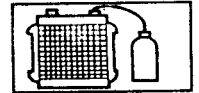

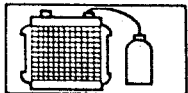

19.10

P.R. 1233

- 1- 77 00 810 997
- 2- 77 00 805 031
- 3- 77 00 792 479
- 4- 77 00 588 916 †
- 5- 77 00 580 192 †
- 6- 77 00 767 519

19.10

P.R. 1233

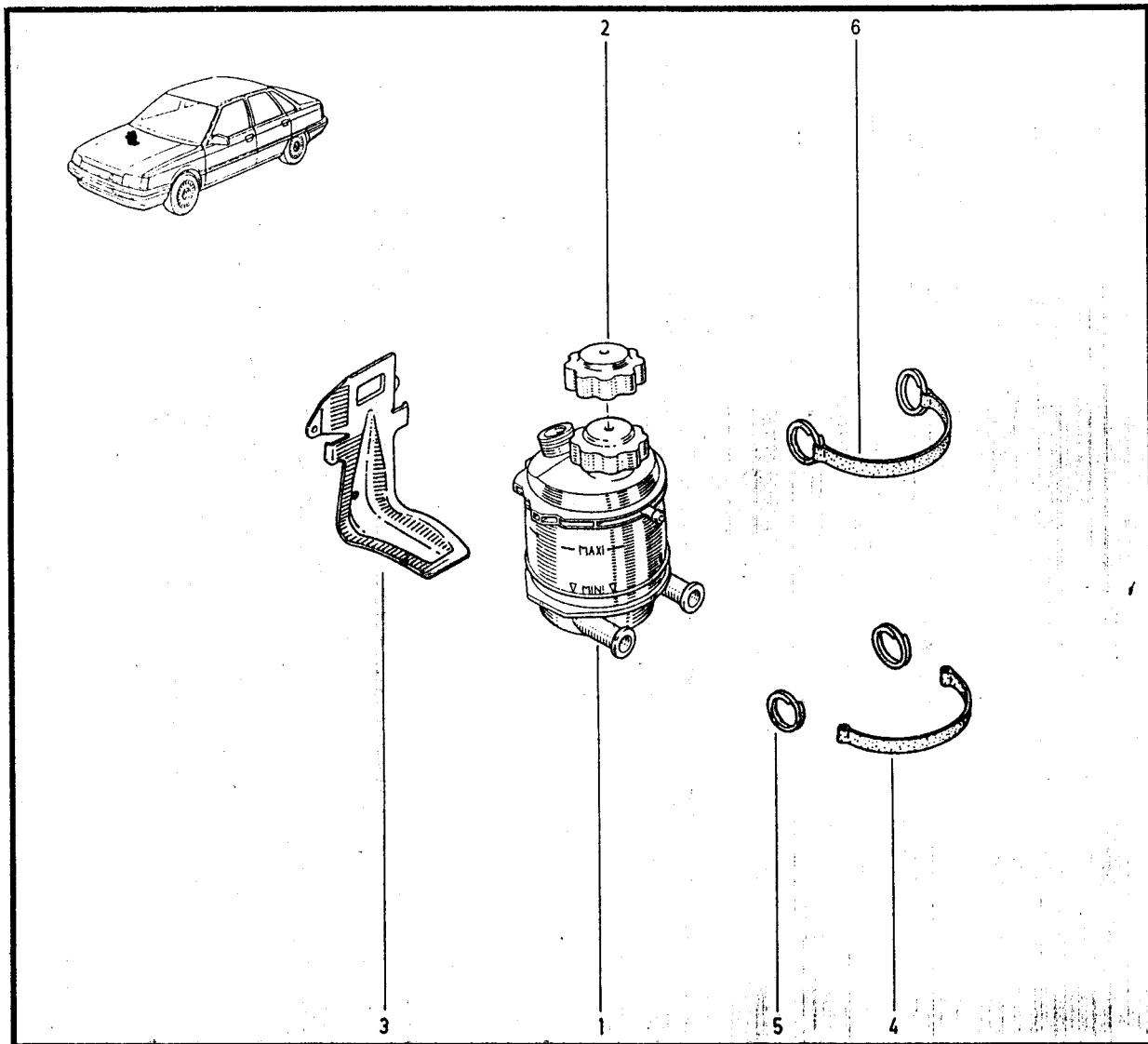
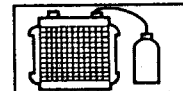

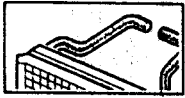

19.20
P.R. 1233

- 1- 77 00 783 013
- 2- 77 00 518 589
- 3- 77 03 061 007
- 4- 77 00 765 108
- 5- 77 02 094 599
- 6- 77 73 083 328
- 7- 77 73 083 332
- 8- 77 03 083 269
- 9- 77 73 083 931

19.20
P.R. 1233

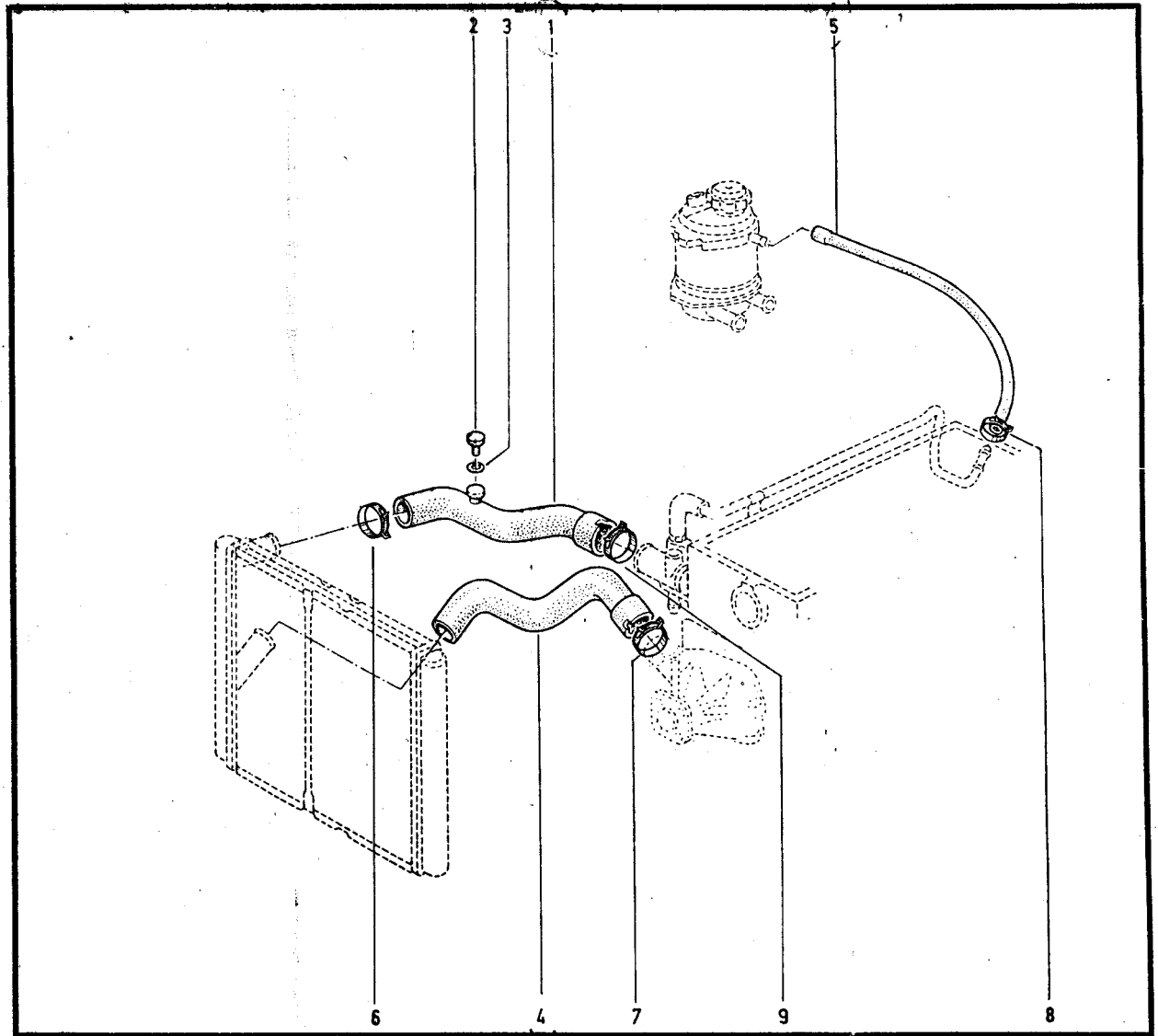

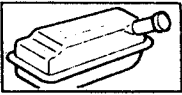

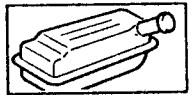

19.30
P.R. 1233

19.30
P.R. 1233

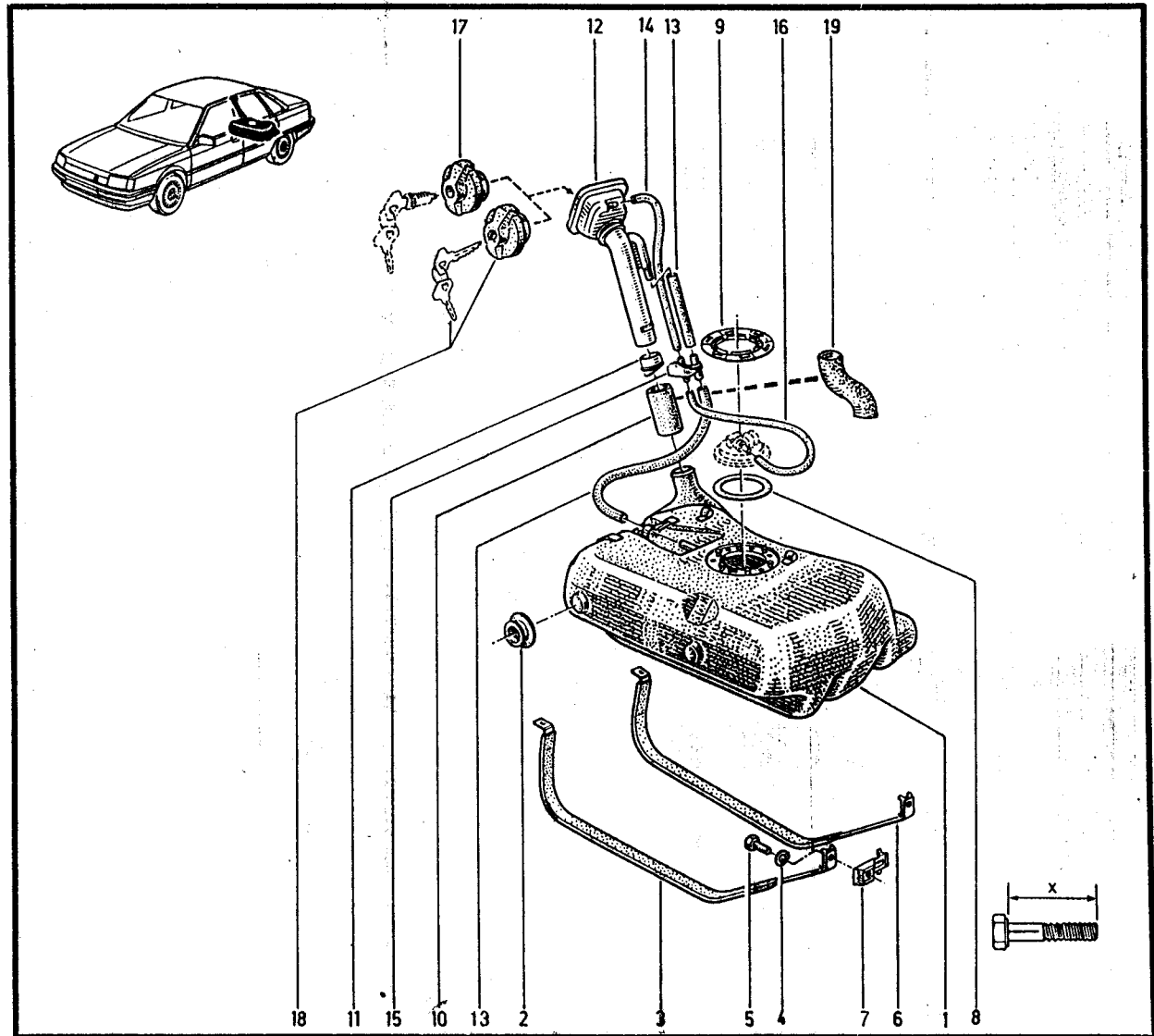

- 1- 77 00 763 384 ☐(c)
- 77 02 094 357 ☐(b)
- 77 00 763 385 ☐(a)†(20)
- 2- 77 00 763 560
- 3- 77 00 785 600
- 77 02 094 320 (1)
- 4- 77 03 055 031
- 5- 77 03 001 608 (x=45)
- 6- 77 00 785 603
- 77 02 094 321 (1)
- 7- 77 03 044 113
- 8- 77 00 782 140
- 9- 77 00 769 133
- 10- 77 05 026 440
- 11- 60 01 007 516
- 12- 77 00 768 038
- 13- 77 05 026 254 ≪1m
- 14- 77 05 026 013 ≪1m †
- 77 02 085 207 ≪1m
- 15- 77 00 772 438
- 16- 77 02 085 057 ≪1m
- 17- 77 02 080 928
- 18- 77 02 088 852
- 19- 77 02 094 310 (1)
- 20- 77 02 094 322 (1)



(a)	L48S  n°	1	n°	00016
	K48S  n°	1	n°	3142

(b)	K48S 092/090
	K488 089
	L48S 091/090
K487 089	

(c)	K48S 210
	K488 202
	L48S 208
	L488 202
K48S 204	

(1)	77 02 094 357
(20)†	7702094357-1
	7702094322-1
	7702094321-1
	7702094320-1
	7702094310-1

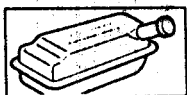

19.30.1

P.R. 1233

Injection

19.30.1

P.R. 1233



- 1- 77 00 779 305 +
- 77 02 217 035 (a)
- 77 00 763 384 (b)
- 2- 77 00 763 560
- 3- 77 02 094 320 (a)
- 77 00 785 600 (b)
- 4- 77 03 055 031
- 5- 77 03 001 608 (x=45)
- 6- 77 02 094 321 (a)
- 77 00 785 603 (b)
- 7- 77 03 044 113
- 8- 77 00 773 009
- 9- 77 00 769 133
- 10- 77 02 094 310 (a)
- 77 00 629 055 (b)
- 11- 60 01 007 516
- 12- 77 00 768 038
- 13- 77 05 026 254 $\times 1m$
- 14- 77 02 085 207 $\times 1m$
- 15- 77 00 772 438
- 16- 77 02 085 057 $\times 1m$
- 17- 77 02 080 928 (a)
- 77 02 094 956 (b)
- 18- 77 02 088 852 (a)
- 77 02 206 678 (b)
- 77 02 219 244 (b)
- 19- 77 02 094 322

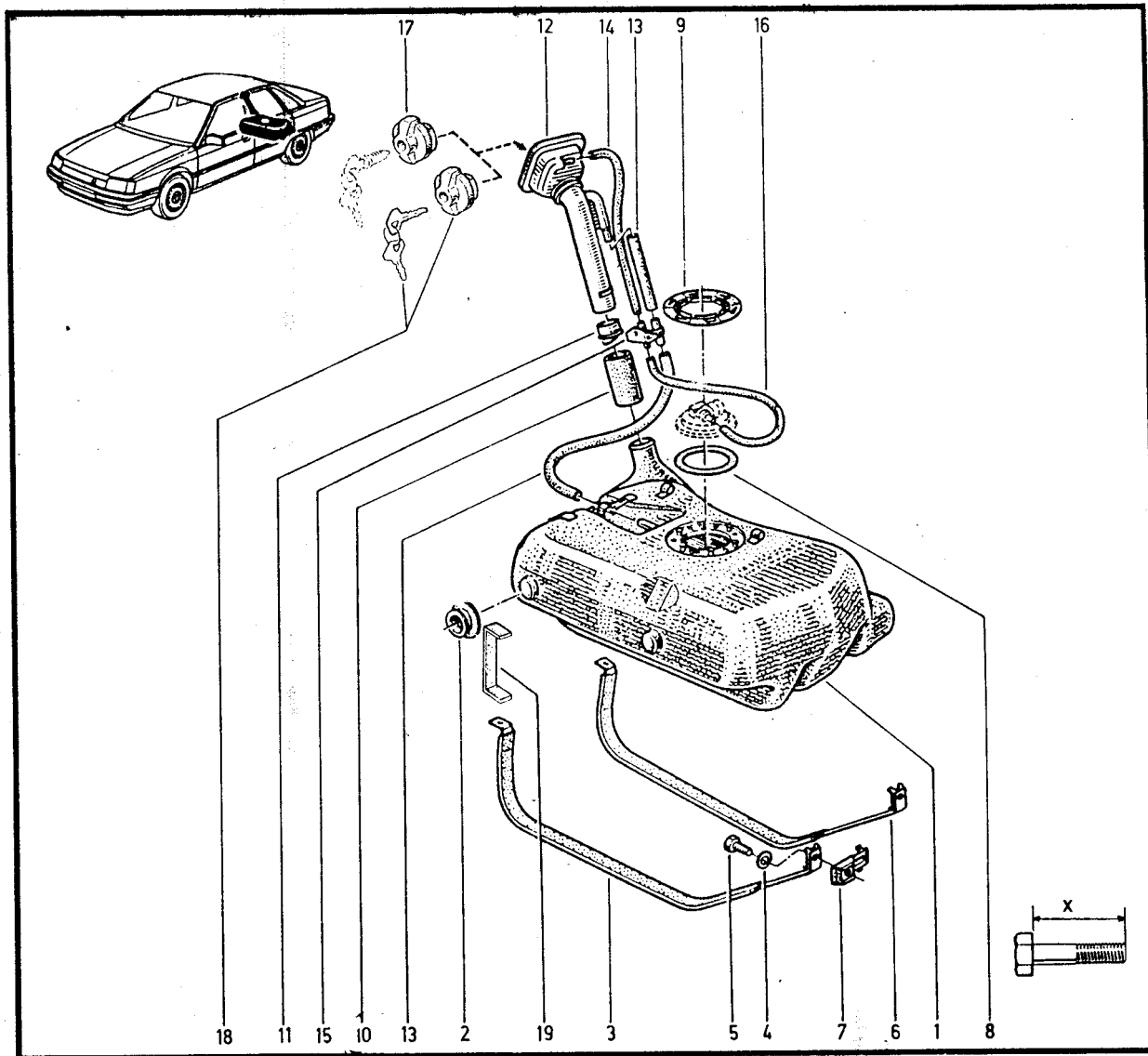

(a) / K48Y 092/090
 L48Z 091/095
 L48Y 091

(b) / K48G 202
 L48G 202
 L48X 208
 K48X 210
 L48K 209

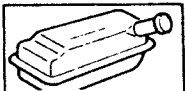

19.40

P.R. 1233

- 1- 77 02 094 496 (a)
- 2- 77 02 094 497 (a)
- 3- 77 00 735 836
- 4- 77 02 094 592
- 5- 77 02 094 948 (b)
- 6- 77 02 094 934 (b)

19.40

P.R. 1233

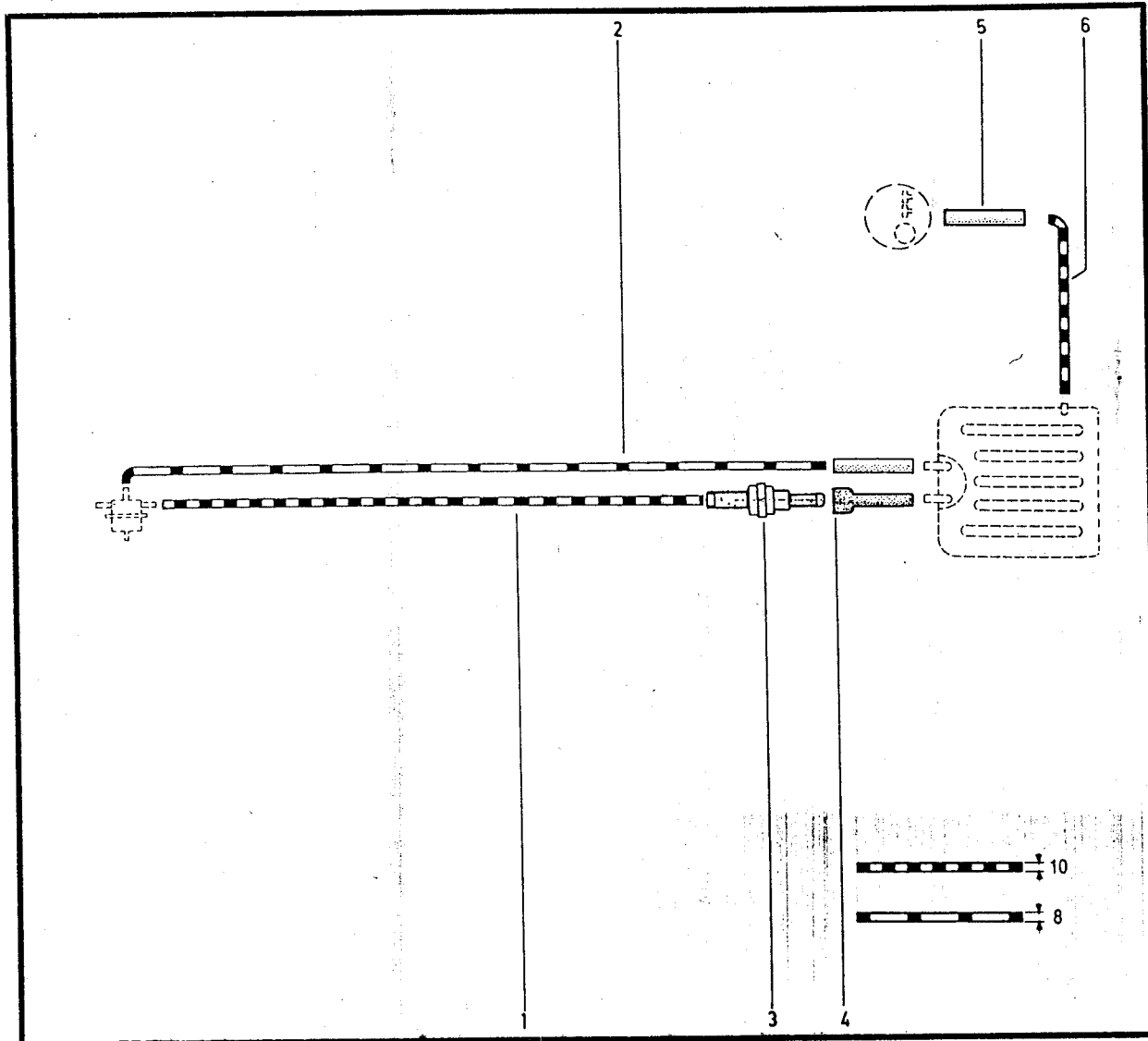

(a) / L48S 208
L488 202
L48S 091/090
L488 089

(b) / L48S 208
L488 202

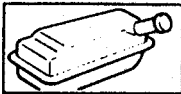

19.40.1

P.R. 1233

- 1- 77 02 094 513 (a)
- 2- 77 02 094 514 (a)
- 3- 77 00 735 836
- 4- 77 02 094 592
- 5- 77 02 094 949 (b)
- * 6- 77 02 094 934 (b)

19.40.1

P.R. 1233

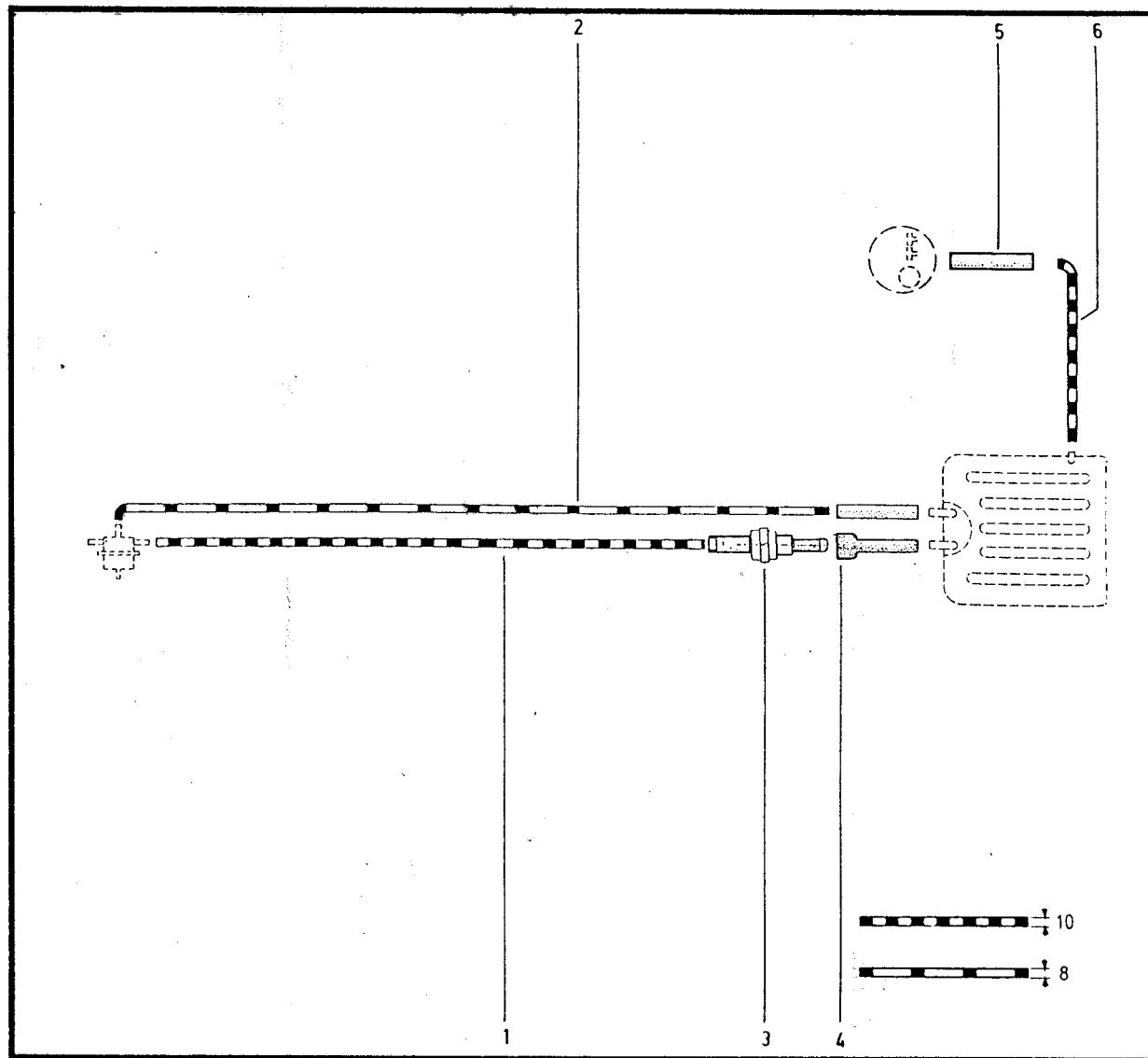

(a)	K487 089	(b)	K48S 210
	K48S 092		K488 202
	K48S 210		K48S 204
	K488 202		
	K48S 090		
	K48S 204		
	K488 089		

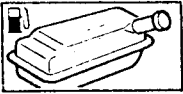

19.40.2

P.R. 1233

Injection

19.40.2

P.R. 1233

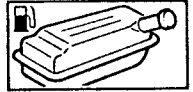

- 1- 77 02 095 220 (b)
- 77 02 094 497 (a)
- 2- 77 02 095 223 (b)
- 3- 77 02 095 088 (b)
- 4- 77 02 094 948 (b)
- 5- 77 02 035 219 (b)
- 77 02 095 003 (a)
- 6- 77 02 095 221 (b)
- 77 02 095 231 (a)
- 7- 77 05 026 997
- 8- 77 02 095 222 (b)

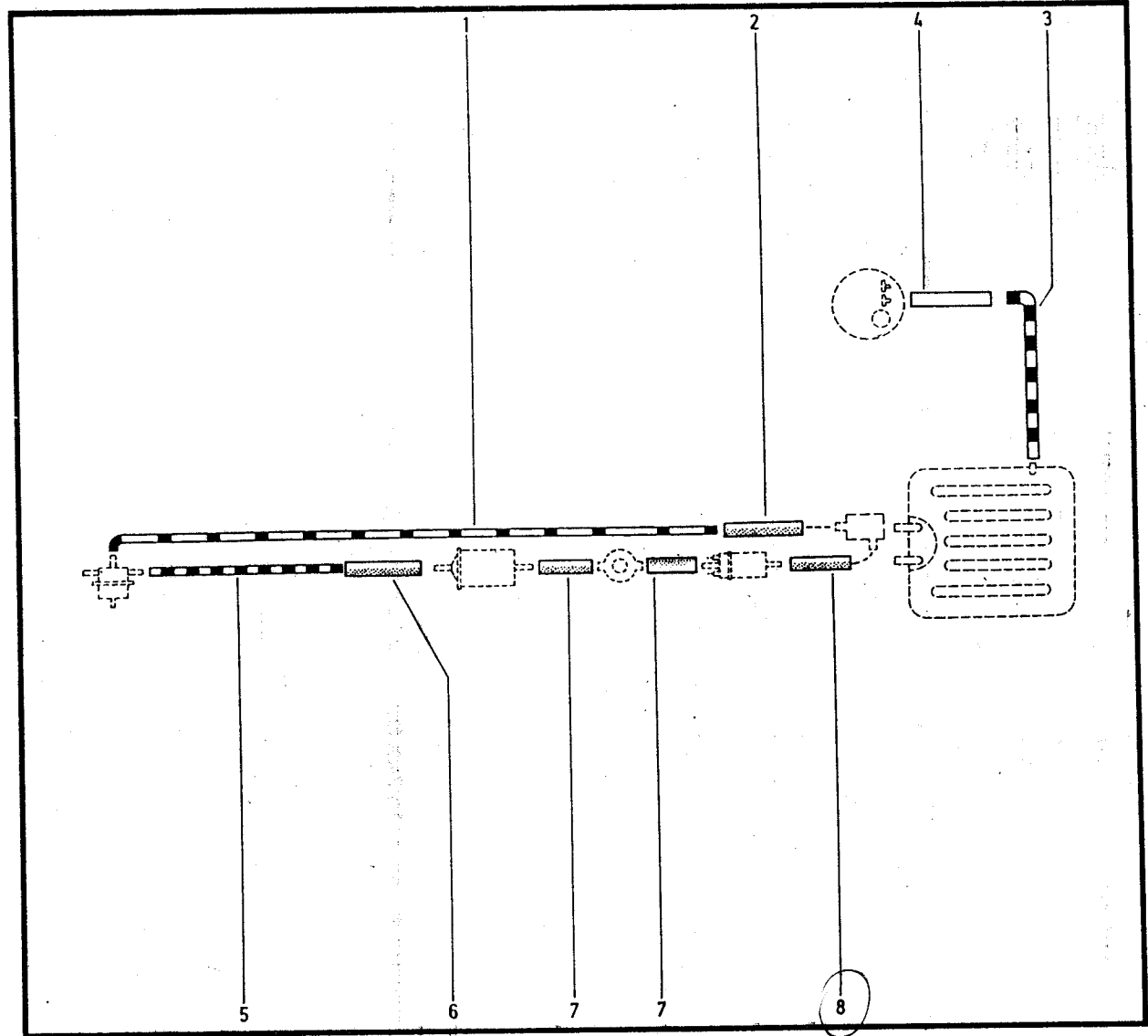

(a) / L48Z 091/095
L48Y 091

(b) / L48G 202
L48K 209
L48K 208
L48X 208

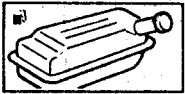

19.40.3
P.R. 1233

Injection

19.40.3
P.R. 1233



- 1- 77 02 095 282
- 2- 77 02 095 285
- 3- 77 02 095 289
- 4- 77 02 094 949
- 5- 77 02 095 281
- 6- 77 02 095 283
- 7- 77 05 026 997
- 8- 77 02 095 284

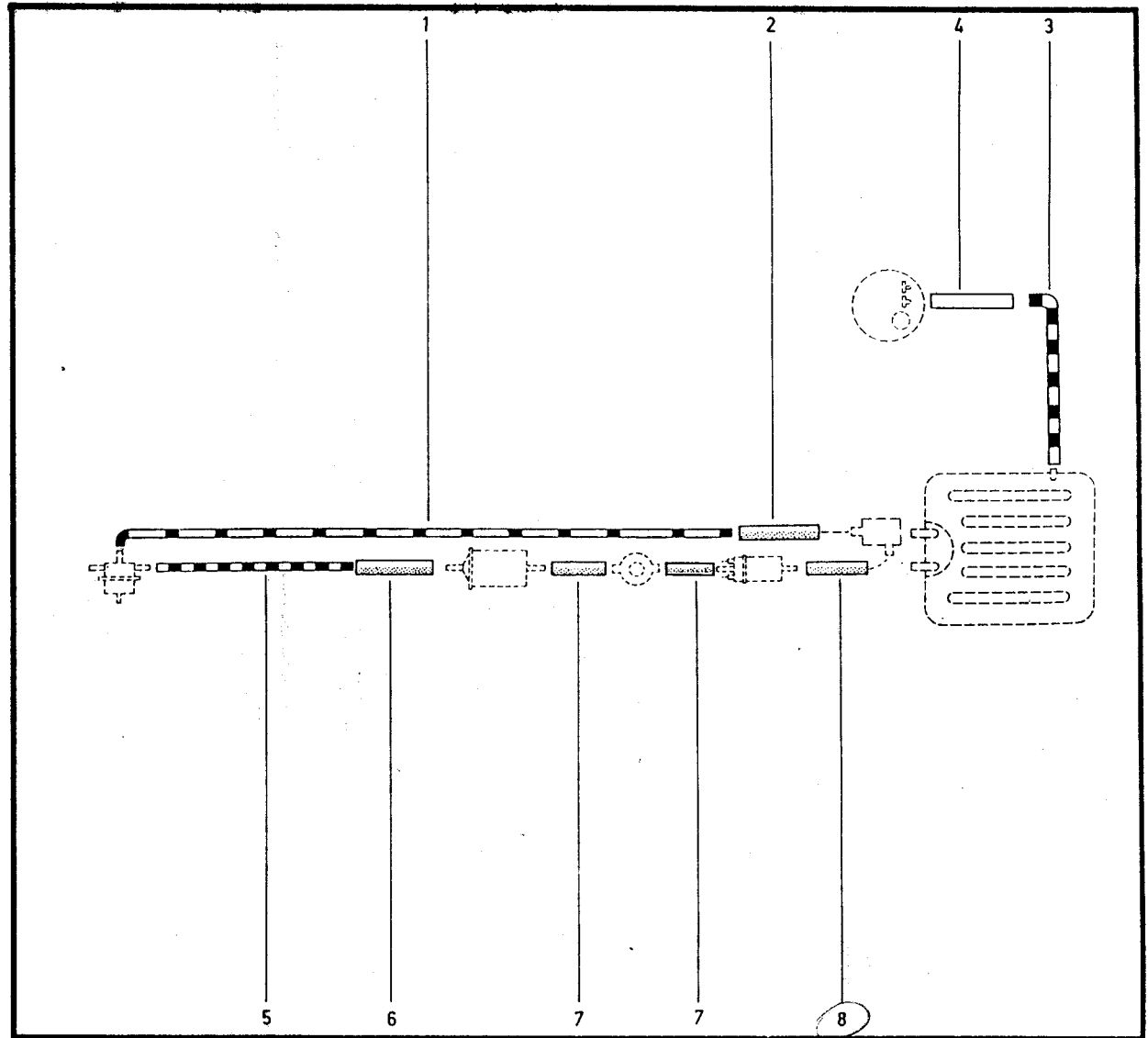

K48X 210
K48G 202

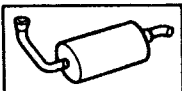

19.50

P.R. 1233

19.50

P.R. 1233



- 1- 77 02 094 155 (a)
- 77 02 094 800 (b)
- 2- 77 03 053 127
- 3- 77 03 032 047
- 4- 77 02 094 894 (c)
- 77 02 094 544 (d)
- 5- 77 03 001 750
- 6- 77 05 001 316 (x=89)
- 77 02 094 552 (x=93)
- 7- 77 05 015 228
- 8- 77 00 737 682 (a)
- 9- 77 05 005 109
- 10- 77 03 016 264
- 11- 77 02 094 551

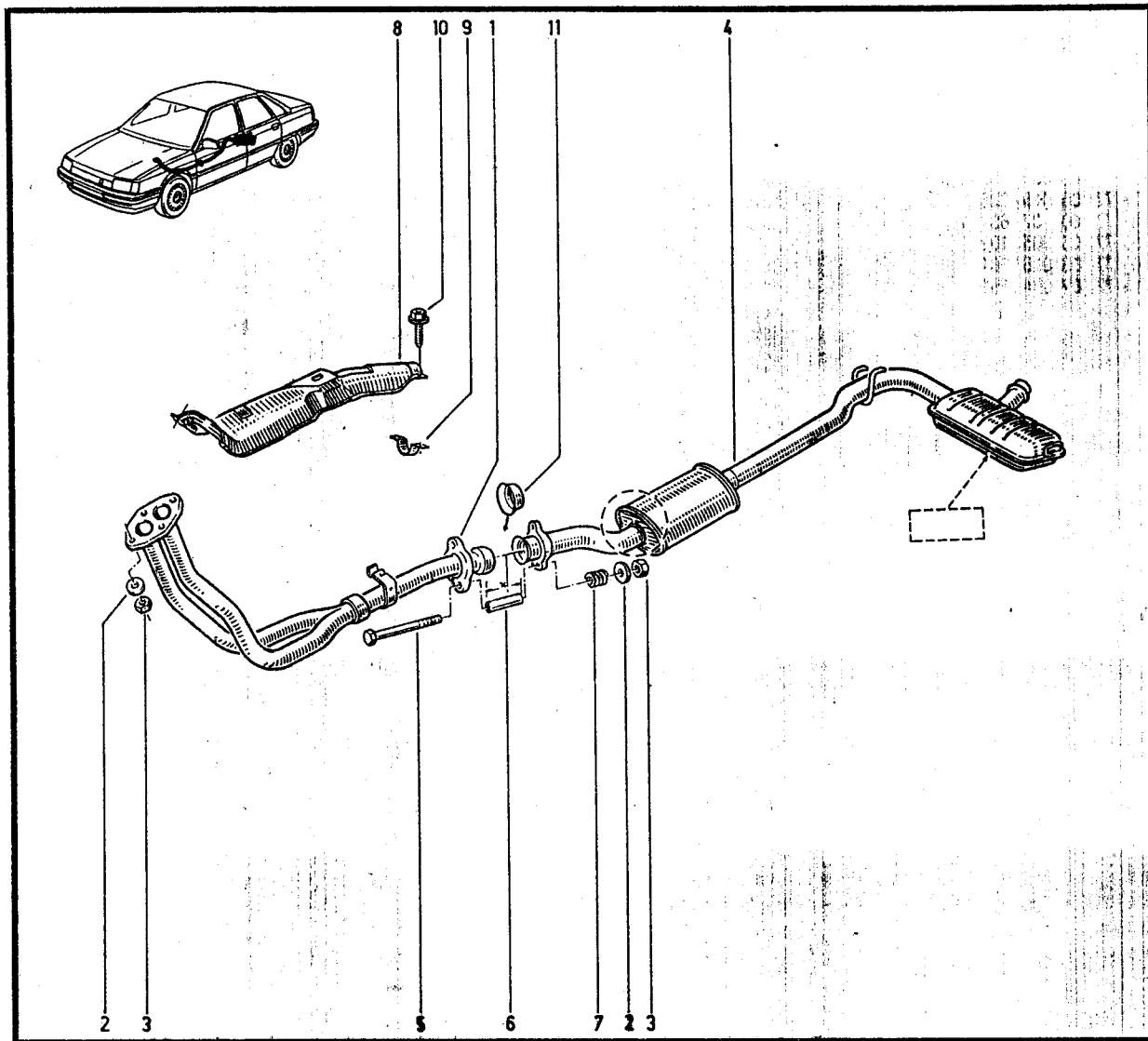

(a)	K48S	(c)	L48S
	L48S		L488
	K488/K487		L489
(b)	L488	(d)	K48S
	L489		K488
	K489		K489

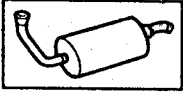

19.50.1
P.R. 1233

Injection

19.50.1
P.R. 1233

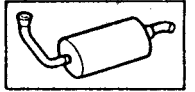

- 1- 77 02 094 155 (a)
- 2- 77 03 053 127
- 3- 77 03 032 047
- 4- 77 02 094 894 (c)
- 77 02 094 544 (d)
- 5- 77 03 001 750
- 6- 77 05 001 316 (x=89)
- 77 02 094 552 (x=93)
- 7- 77 05 015 228
- 8- 77 00 737 682 (a)
- 9- 77 05 005 109
- 10- 77 03 016 264
- 11- 77 02 094 551

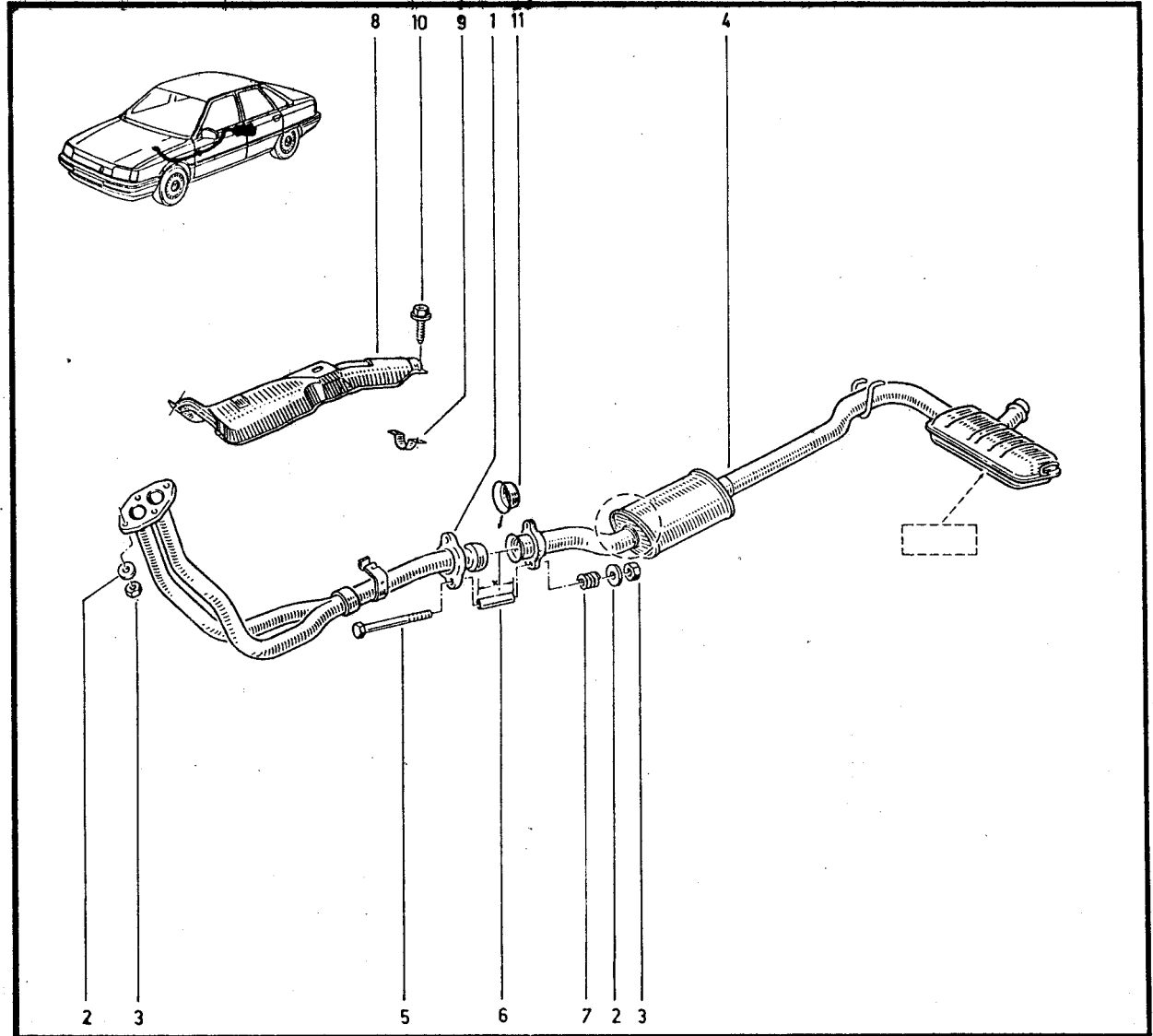

- | | |
|-----|--------------|
| | L48Z 091/095 |
| (a) | K48Y 092/090 |
| | L48Y 091 |
| (c) | L48Y 091 |
| | L48Z 095/091 |
| (d) | K48Y 090/092 |

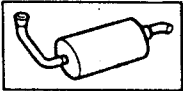

19.54.1

.P.R. 1233

Injection

19.54.1

.P.R. 1233



- 1- 77 02 095 015
- 2- 77 03 053 127
- 3- 77 03 034 087
- 4- 77 00 807 183
- 5- 77 02 095 188
- 6- 77 03 001 177
- 7- 77 05 001 310
- 8- 77 05 015 228
- 9- 77 02 095 019 (a)
- 77 02 095 279 (b)
- 10- 77 00 775 438
- 11- 77 05 005 109
- 12- 77 00 776 909
- 13- 77 00 775 609
- 14- 77 05 005 123
- 15- 77 03 046 049
- 16- 77 03 016 264
- 17- 77 00 774 874
- 18- 77 00 708 605
- 19- 77 00 795 497

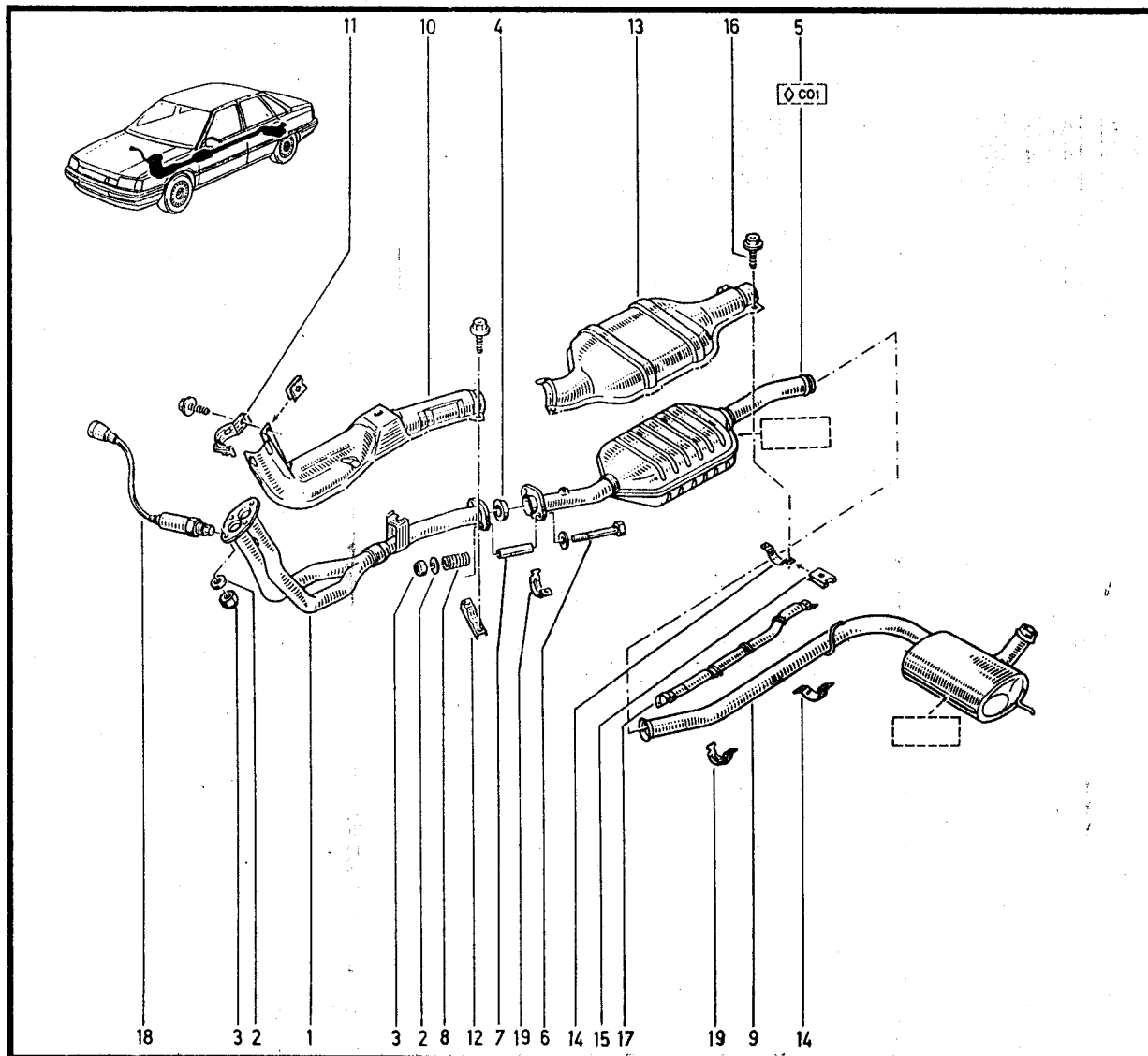

(a)	L48G 202
	L48K 209
	L48K 208
	L48X 208

(b)	K48G 202
	K48X 210



19.60

P.R. 1233

- 1- 77 02 094 852 (a)
- 77 02 095 005 (b)
- 77 02 095 004 (c)
- 77 02 094 853 (d)
- 2- 77 00 786 872
- 3- 77 03 033 027

19.60

P.R. 1233

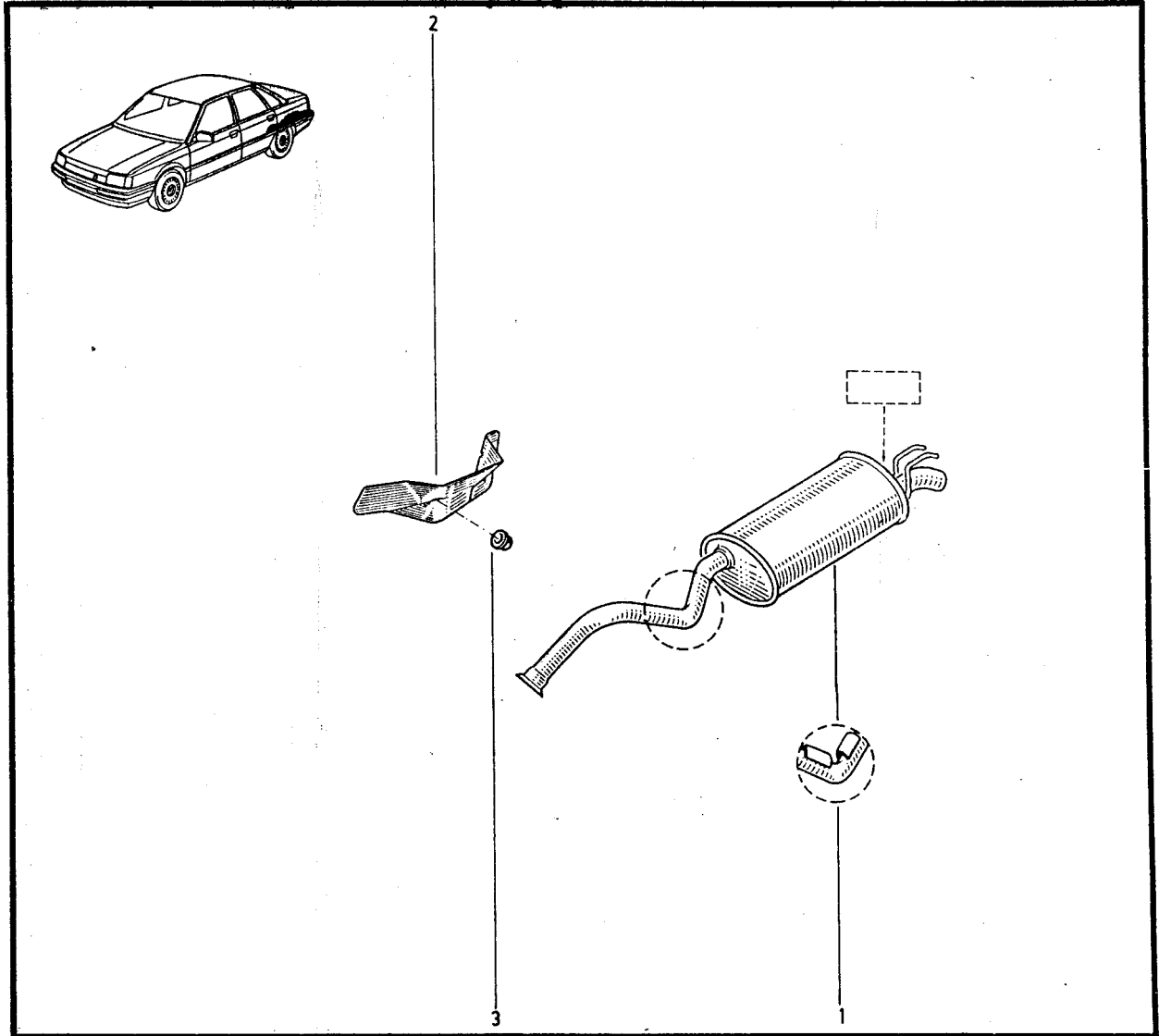
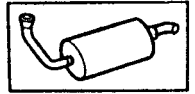

(a) L48S 090/091
L488 089
 L489

(b) K48S 204
K48S 210
K488 202
 K489

(c) L48S 208
L488 202
K48S 090/092
K488 089 / K487

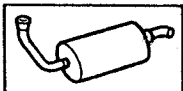

19.60.1

P.R. 1233

Injection

19.60.1

P.R. 1233

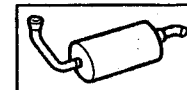

- 1- 77 02 094 852 (a)
- 77 02 094 853 (b)
- 77 02 095 005 (c)
- 77 02 095 004 (d)
- 2- 77 00 786 872 (e)
- 3- 77 03 033 027

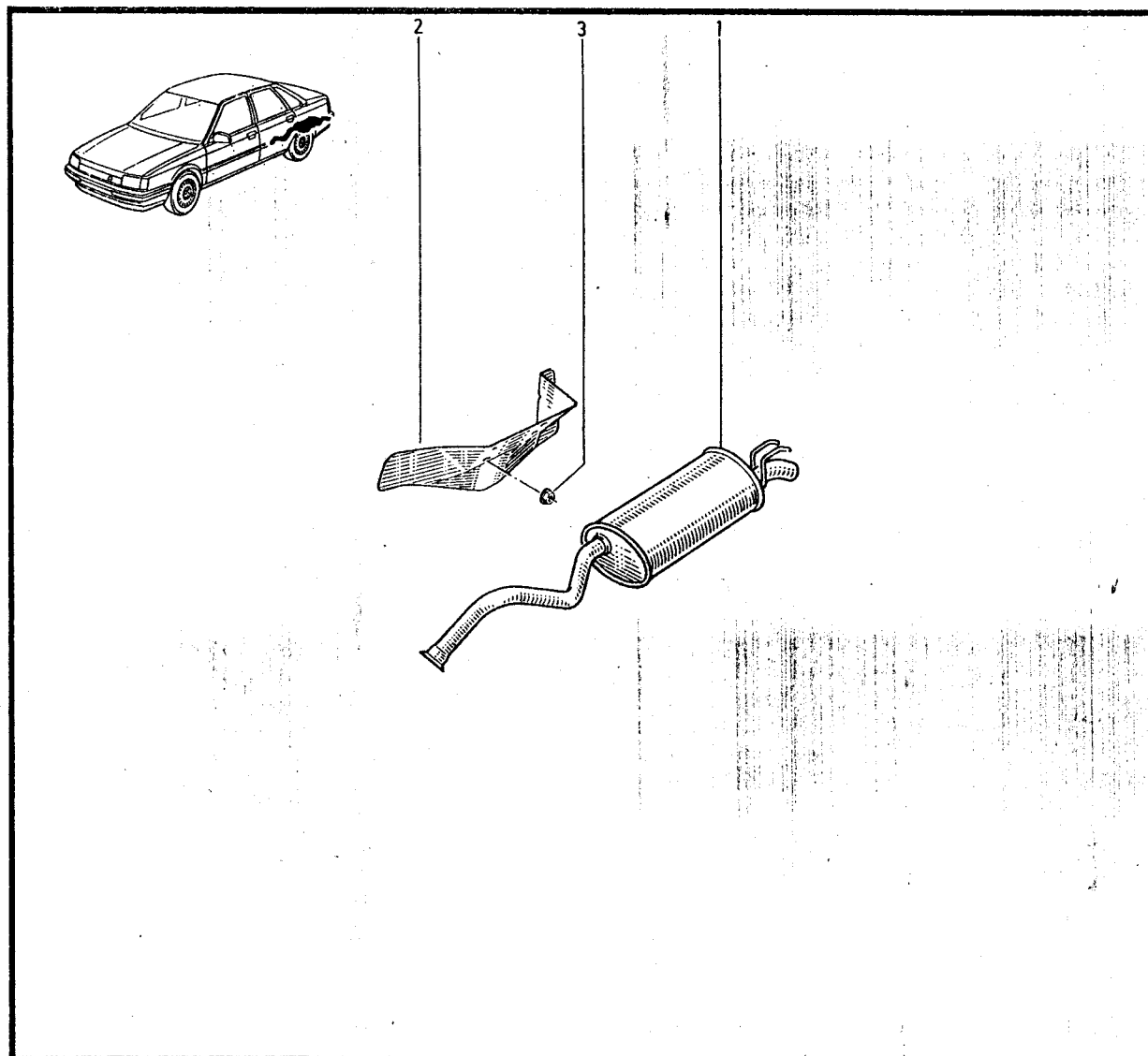

- (a) / L48Y 091
L48Z 095/091
- (b) / K48Y 092/090
- (c) / K48X 210
K48G 202

- (d) / L48G 202
L48X 208
L48K 209-208
- (e) / K48X 210
K48G 202

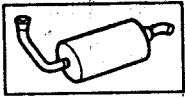

19.60.2
P.R. 1233

Injection

19.60.2
P.R. 1233

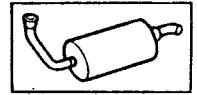

- 1- 77 02 095 005 (a)
- 77 02 095 004 (b)
- 2- 77 02 095 197
- * 3- 77 03 033 027

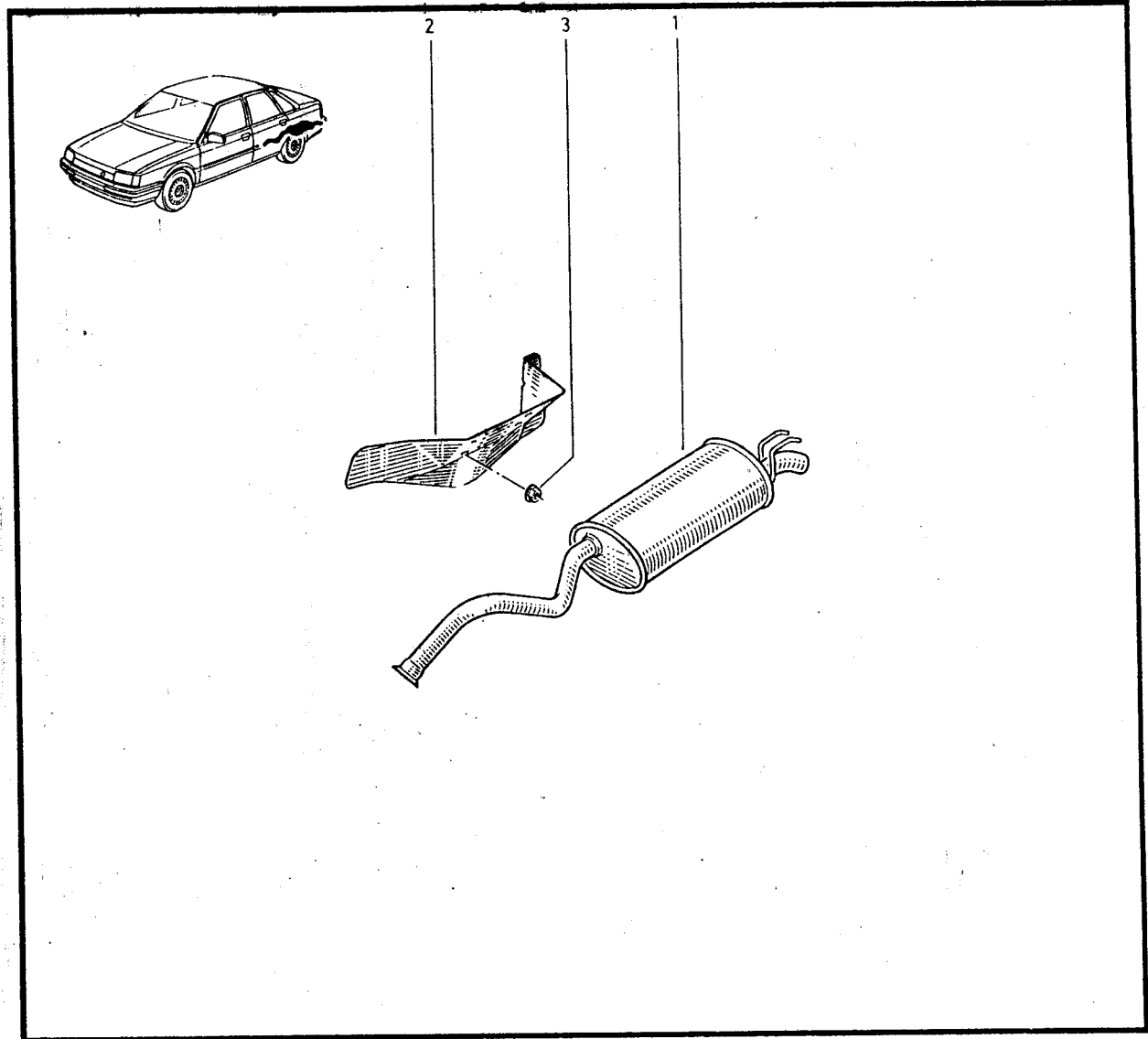

(a) / K48X 210
K48G 202

(b) / L48G 202
L48K 209
L48X 208
L48K 208

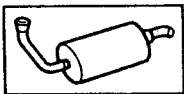

19.70
P.R. 1233

1 - 77 01 464 057
2 - 77 01 458 596

19.70
P.R. 1233

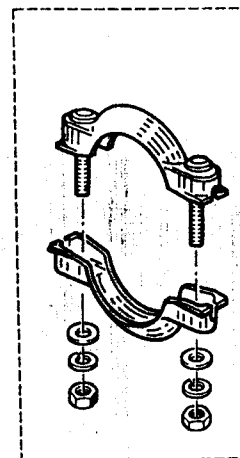
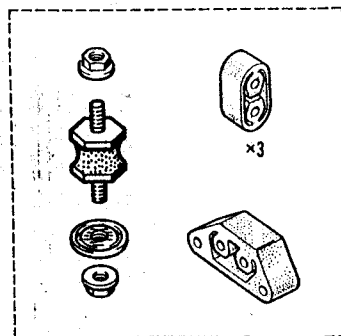
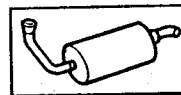



19.80

P.R. 1233

- 1 - 77 00 766 248
- 2 - 77 03 101 069
- 3 - 77 03 058 043
- 4 - 77 00 769 719
- 5 - 77 03 053 043
- 6 - 77 03 034 106
- 7 - 77 03 034 122
- 8 - 77 00 766 249
- 9 - 77 00 766 126
- 10 - 77 00 766 250
- 11 - 77 00 766 247
- 12 - 77 00 769 720

19.80

P.R. 1233

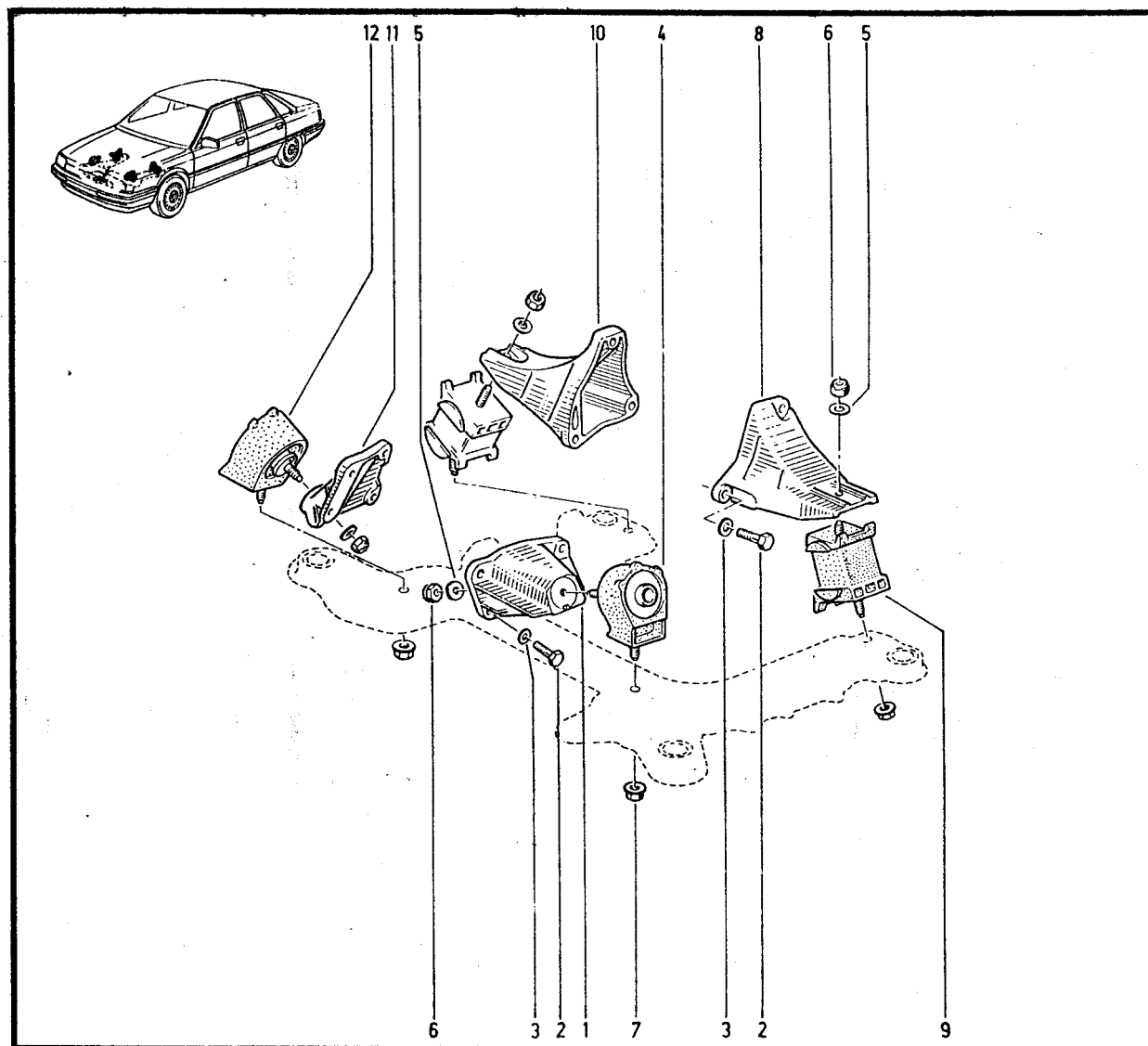
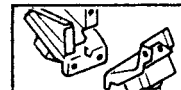

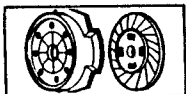

20.01

P.R. 1233

- 1-77 02 096 364
- 2-77 02 096 128
- 3-77 03 009 059
- 4-77 03 055 022
- 77 03 055 035
- 5-77 03 053 036

20.01

P.R. 1233

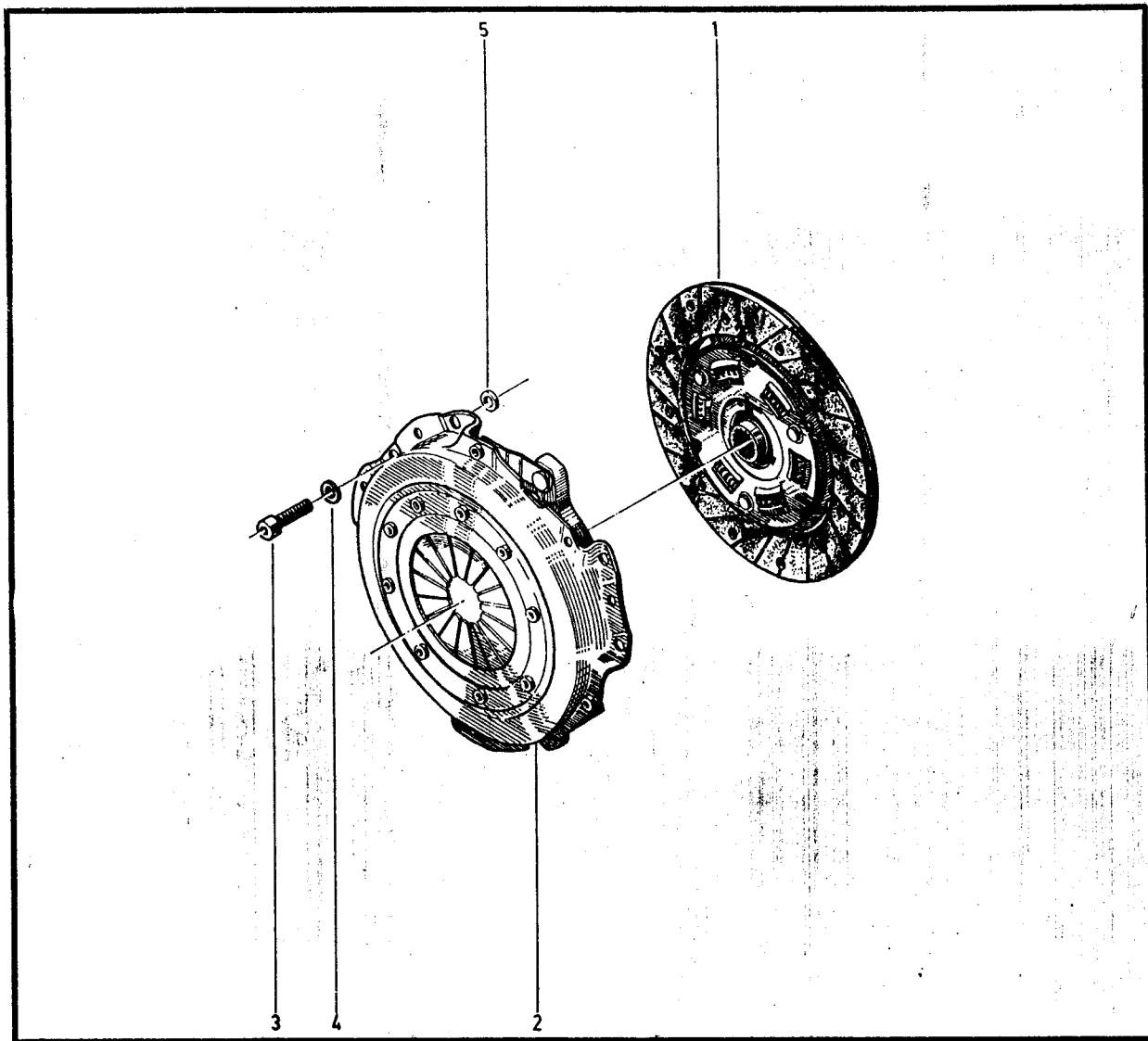
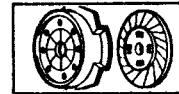



21.01

P.R. 1233

21.01

P.R. 1233



- 1- 77 02 096 170 †(b)
- 2- 77 02 096 256 †
- 3- 77 02 096 390 (a)
- 4- 77 02 096 383 (b)

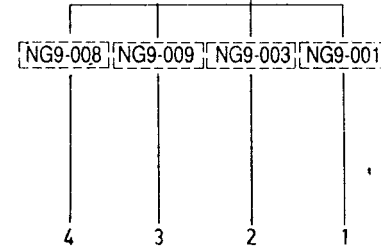
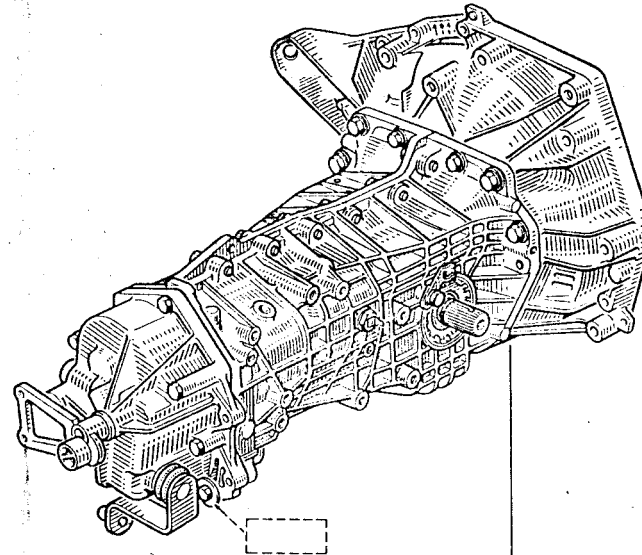

- | | |
|-----|----------|
| (a) | K48S 092 |
| | L48S 091 |
| | K48S 090 |
| | K488 089 |
| | L488 089 |

- | | |
|-----|----------|
| (b) | K48S 204 |
| | K488 202 |
| | L488 202 |
| | K48S 210 |
| | L48S 208 |



21.01.1

P.R. 1233

Injection

21.01.1

P.R. 1233



- 1- 77 02 096 344 †
- 2- 77 02 096 392 (a)
- 3- 77 02 096 416 (b)

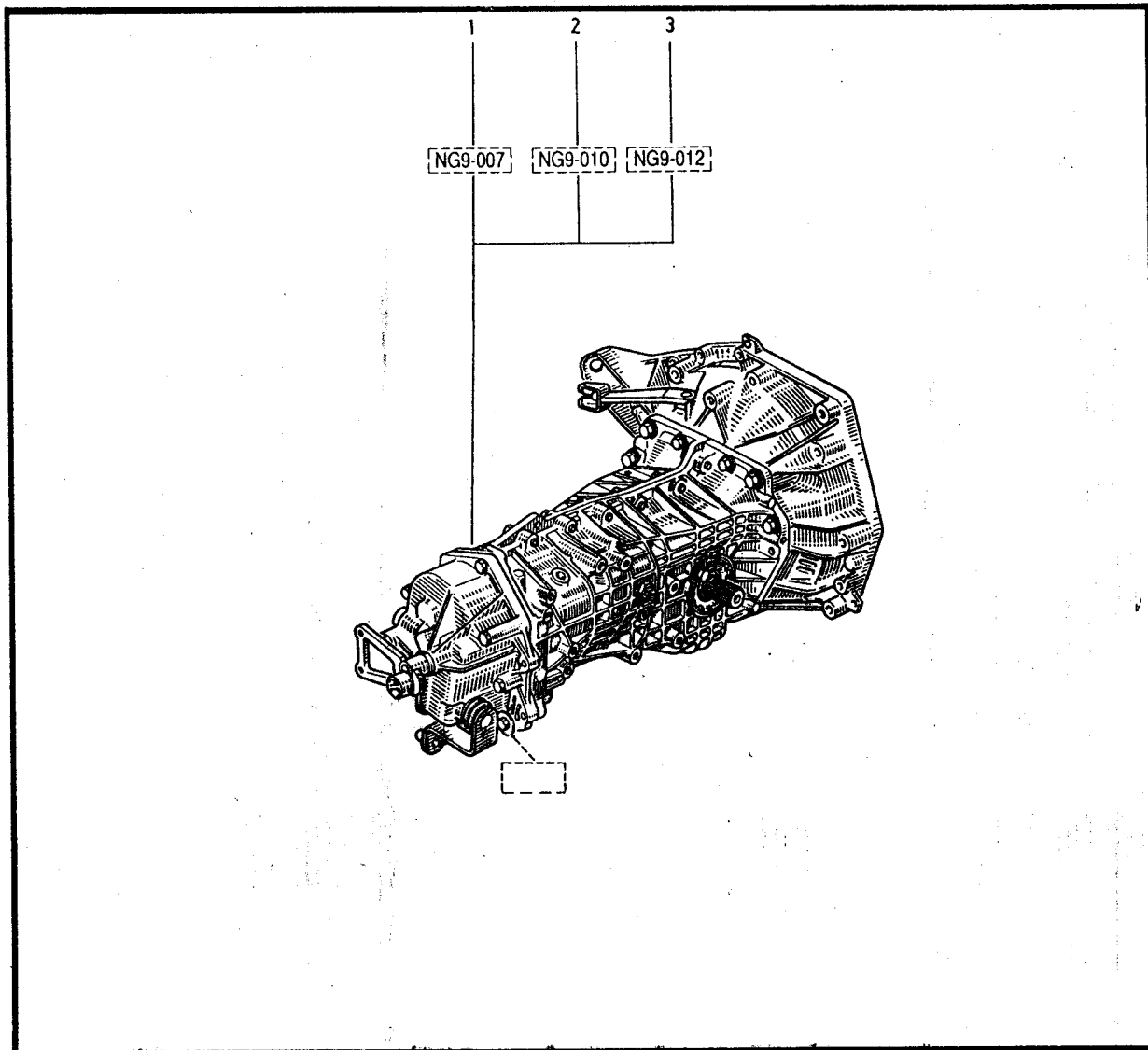

	K48G 202
	L48G 202
	L48K 209
(a)	L48Z 091
	K48X 210
	L48K 208
	L48X 208

	K48Y 090
(b)	L48Y 091
	K48Y 092

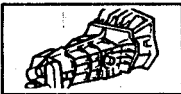

21.20.1

P.R. 1233

(a)

21.20.1

P.R. 1233

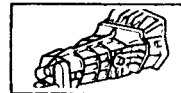

- 1-77 02 096 264
- 2-77 00 717 540
- 3-77 03 001 241
- 4-77 03 001 822
- 5-77 03 001 240
- 6-77 03 001 608
- 7-77 02 021 841
- 8-77 01 348 471
- 9-77 03 001 373
- 10-77 03 001 820
- 11-79 03 053 043
- 12-77 01 462 174
- 13-77 03 087 106
- 14-77 00 683 559
- 15-77 03 065 074
- 16-77 00 633 193
- 17-77 03 001 158 (x=16)
- 18-77 03 053 521
- 19-04 01 875 800
- 20-77 00 629 541
- 21-77 03 075 012
- 22-77 03 075 072
- 23-77 01 465 892 + (b)(10)
- 77 02 096 340 (c)
- 24-77 03 075 059
- 25-77 03 001 238 (x=65)
- 26-77 03 001 443 (x=85)
- 27-77 03 058 006
- 28-77 03 001 614 (x=30)
- 29-77 03 001 423 (x=80)
- 30-77 05 010 085
- 31-77 04 002 578
- 32-77 05 010 101
- 33-77 00 746 096

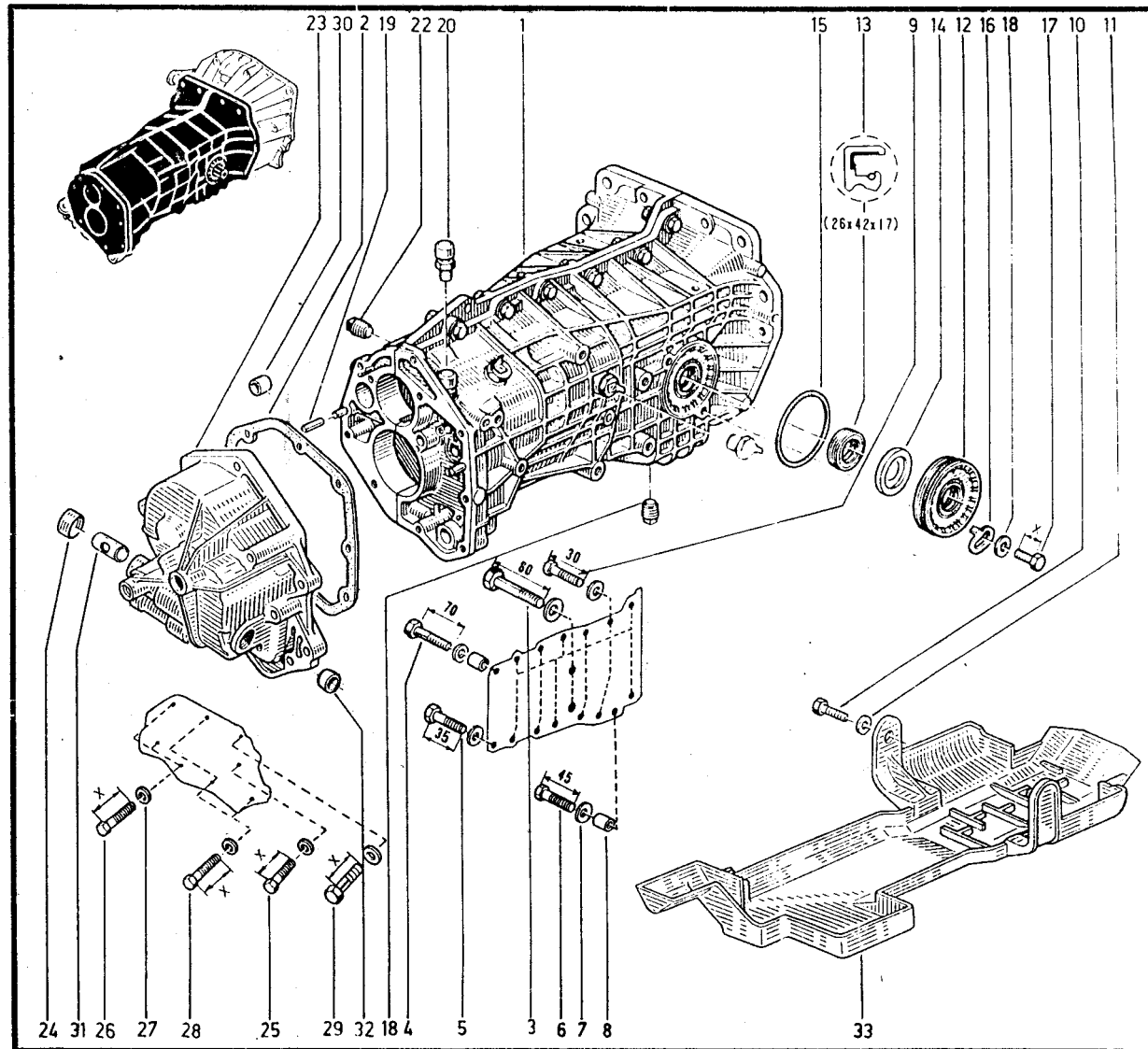

(a)	NG9-001	n° 2644	⇒ n°
	NG9-003	n° 113	⇒ n°
(b)	NG9-001	n° 1	⇒ n°
	NG9-003	n° 1	⇒ n° 5933

(c)	NG9-001	n° 5934	n° 3077
	NG9-003	n° 3078	n°
	NG9-007	n° 1	n°
	NG9-009	n° 1	n°
	NG9-010	n° 1	n°

(10) 7702096340-1
7700719559-1



21.30

P.R. 1233

21.30

P.R. 1233



- 1-77 00 749 339
- 2-77 04 000 454
- 3-77 02 027 229
- 4-77 03 001 188(x=45)
- 5-77 03 055 013
- 6-79 03 053 050
- 7-77 03 001 186(x=35)
- 8-77 03 001 165(x=35)
- 9-77 03 055 011
- 10-79 03 053 043
- 11-77 03 001 196(x=90)
- 12-77 03 001 451(x=95)
- 13-77 03 055 013
- 14-04 28 724 300
- 15-77 03 001 164(x=30)
- 16-77 00 743 231
- 17-77 03 001 167(x=40)
- 18-77 05 010 188

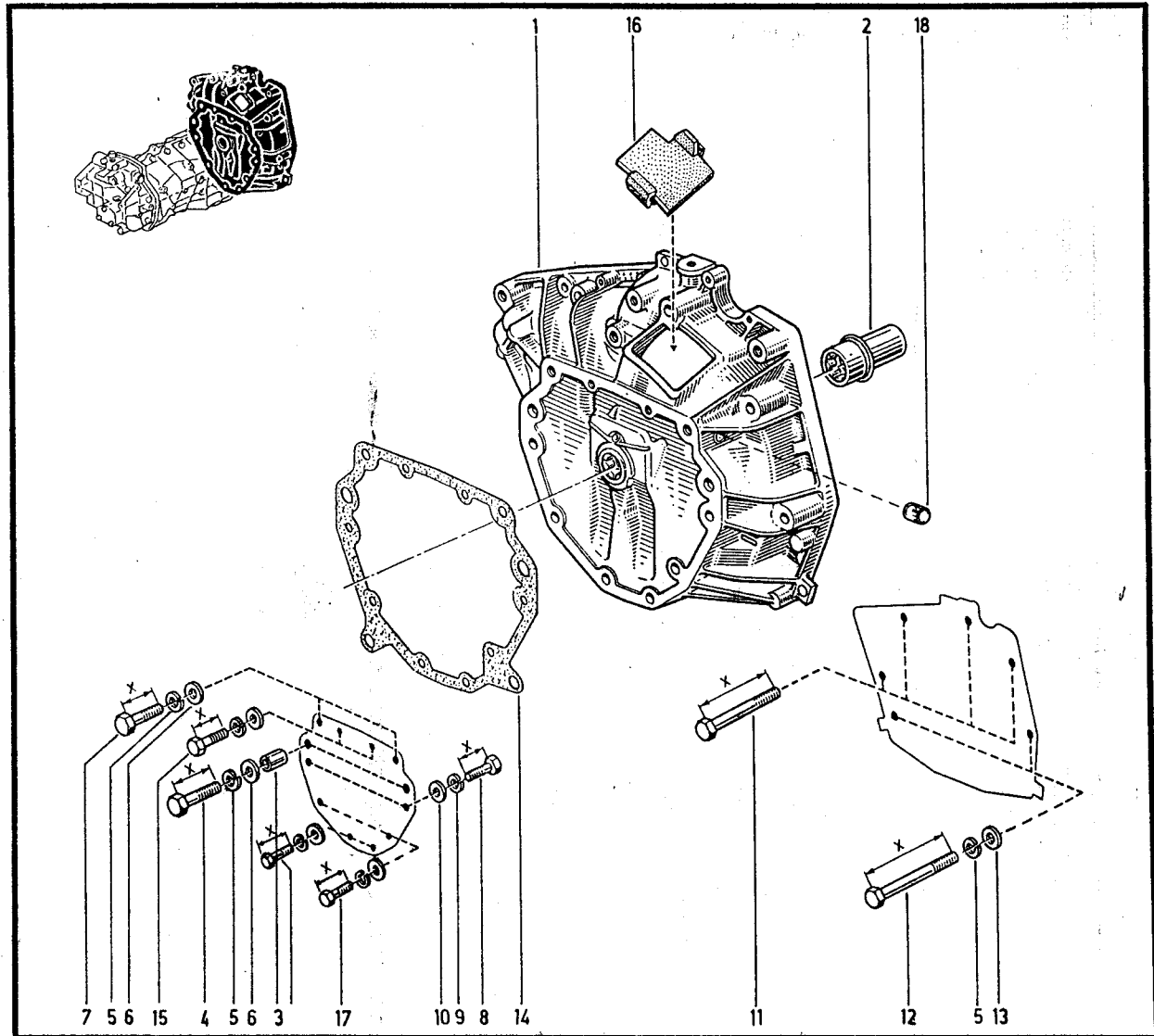

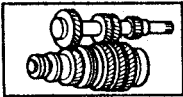

21.40

P.R. 1233

21.40

P.R. 1233

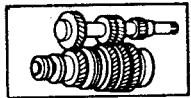

- 1- 77 00 858 699 (a)
- 77 02 096 275 (b)
- 2- 77 03 090 400
- 3- 77 03 090 256
- 4- 77 03 066 269
- 5- 77 03 055 011
- 6- 77 02 096 164
- 7- 77 03 067 030
- 8- 77 00 658 595
- 9- 77 00 679 059
- 10- 77 03 090 244
- 11- 77 03 066 192
- 12- 77 02 096 146
- 13- 05 56 112 500
- 14- 77 08 724 429 (x=1,8)
- 77 03 056 372 (x=2,8)
- 15- 77 00 725 747
- 16- 77 02 089 348
- 17- 77 02 096 147 (☆=37)(A=28,36)
- 18- 77 00 721 375
- 19- 77 03 066 377 (x=2,8)
- 77 08 724 428 (x=1,8)
- 20- 77 00 721 374
- 21- 77 02 096 148 (A=27,56)
- 22- 77 00 708 152
- 23- 77 01 463 612
- 24- 77 00 737 092
- 25- 77 00 667 703
- 26- 77 02 096 149 (☆=34)
- 27- 77 03 090 245
- 28- 77 00 707 307
- 29- 77 02 096 142
- 30- 77 01 348 540
- 31- 77 01 348 472
- 32- 77 03 066 159
- 33- 77 00 732 219
- 34- 77 00 577 584
- 35- 77 05 015 147
- 36- 77 03 090 297
- 37- 77 03 090 367
- 38- 77 02 096 150 (☆=36)(x=19)
- 39- 77 01 463 611
- 40- 77 00 656 205

- 41- 77 03 058 047
- 42- 77 03 040 028
- 43- 77 00 850 323
- 44- 77 02 096 151 (☆=31)(x=18,30)
- 45- 77 03 090 295

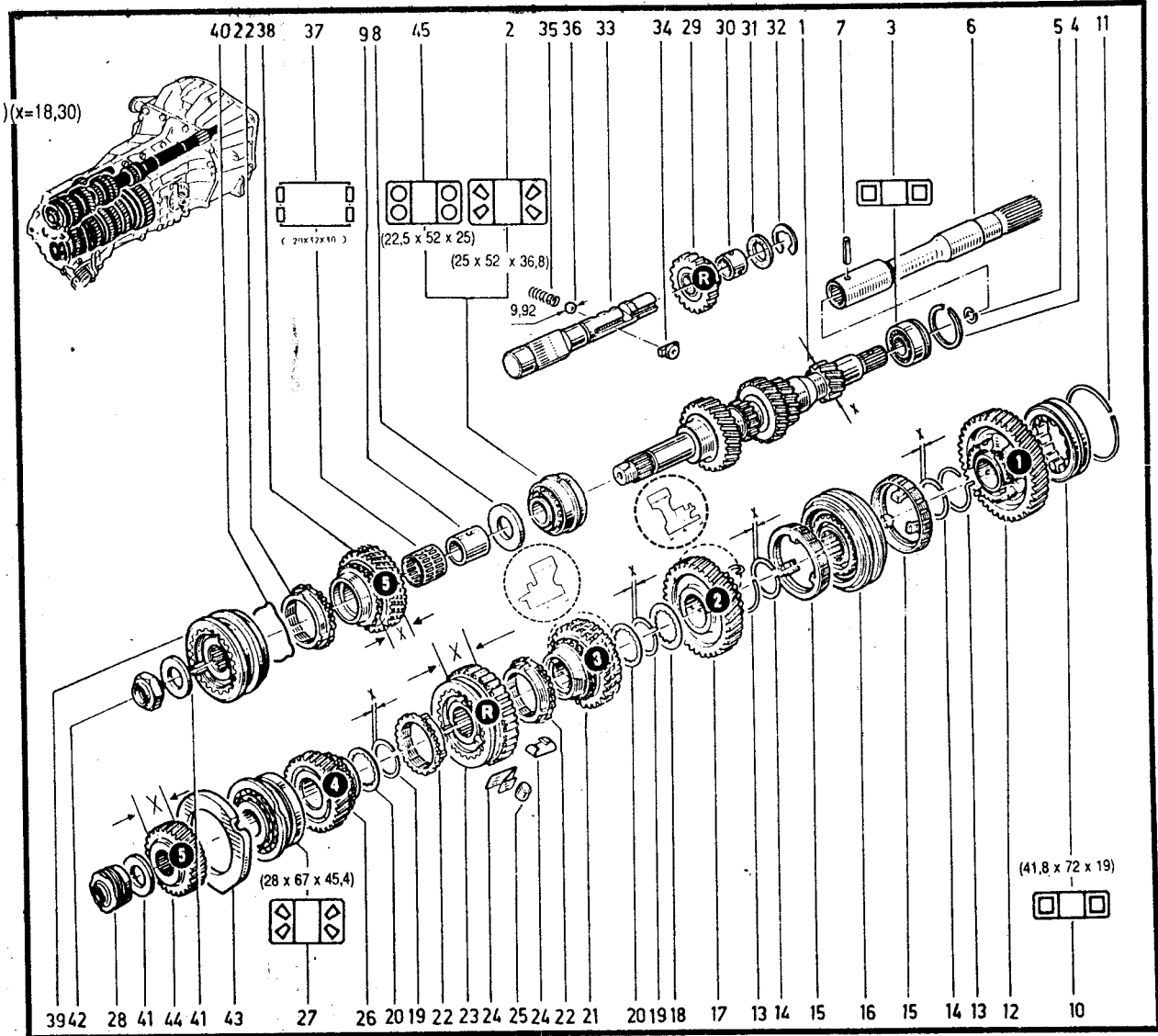

(a)	NG9-001	n°	1	⇒ n° 9662
	NG9-003	n°	1	⇒ n° 4725
	NG9-008	n°	1	⇒ n° 5

(a) NG9-000/NG9-001/008
 (b) NG9-003

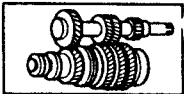

21.40.1

P.R. 1233

(a)

21.40.1

P.R. 1233

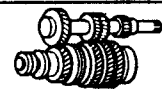

- 1- 77 00 858 699 (a)
- 77 02 096 275 (b)
- 2- 77 03 090 400
- 3- 77 03 090 256
- 4- 77 03 066 269
- 5- 77 03 055 011
- 6- 77 02 096 164
- 7- 77 03 067 030
- 8- 77 00 658 595
- 9- 77 00 679 059
- 10- 77 03 090 244
- 11- 77 03 066 192
- 12- 77 02 096 146
- 13- 05 56 112 500
- 14- 77 08 724 429 (x=1,8)
- 77 03 066 372 (x=2,8)
- 15- 77 00 725 747
- 16- 77 02 089 348
- 17- 77 02 096 295 (☆=37) (A=27,67)
- 18- 77 00 721 375
- 19- 77 03 066 386 (x=3,37)
- 20- 77 00 721 374
- 21- 77 02 096 296 (A=26,96)
- 22- 77 00 708 152
- 23- 77 01 463 612
- 24- 77 00 737 092
- 25- 77 00 667 703
- 26- 77 02 096 149 (☆=34)
- 27- 77 03 090 245
- 28- 77 00 707 307
- 29- 77 02 096 142
- 30- 77 05 010 008
- 31- 77 01 348 472
- 32- 77 03 066 159
- 33- 77 00 732 219
- 34- 77 00 577 584
- 35- 77 05 015 147
- 36- 77 03 090 297
- 37- 77 03 090 261
- 38- 77 02 096 150 (☆=36) (x=19)
- 39- 77 01 463 611
- 40- 77 00 656 205
- 41- 77 03 058 047
- 42- 77 03 040 028
- 43- 77 00 850 323
- 44- 77 02 096 151 (☆=31) (x=18,30)
- 45- 77 03 090 295

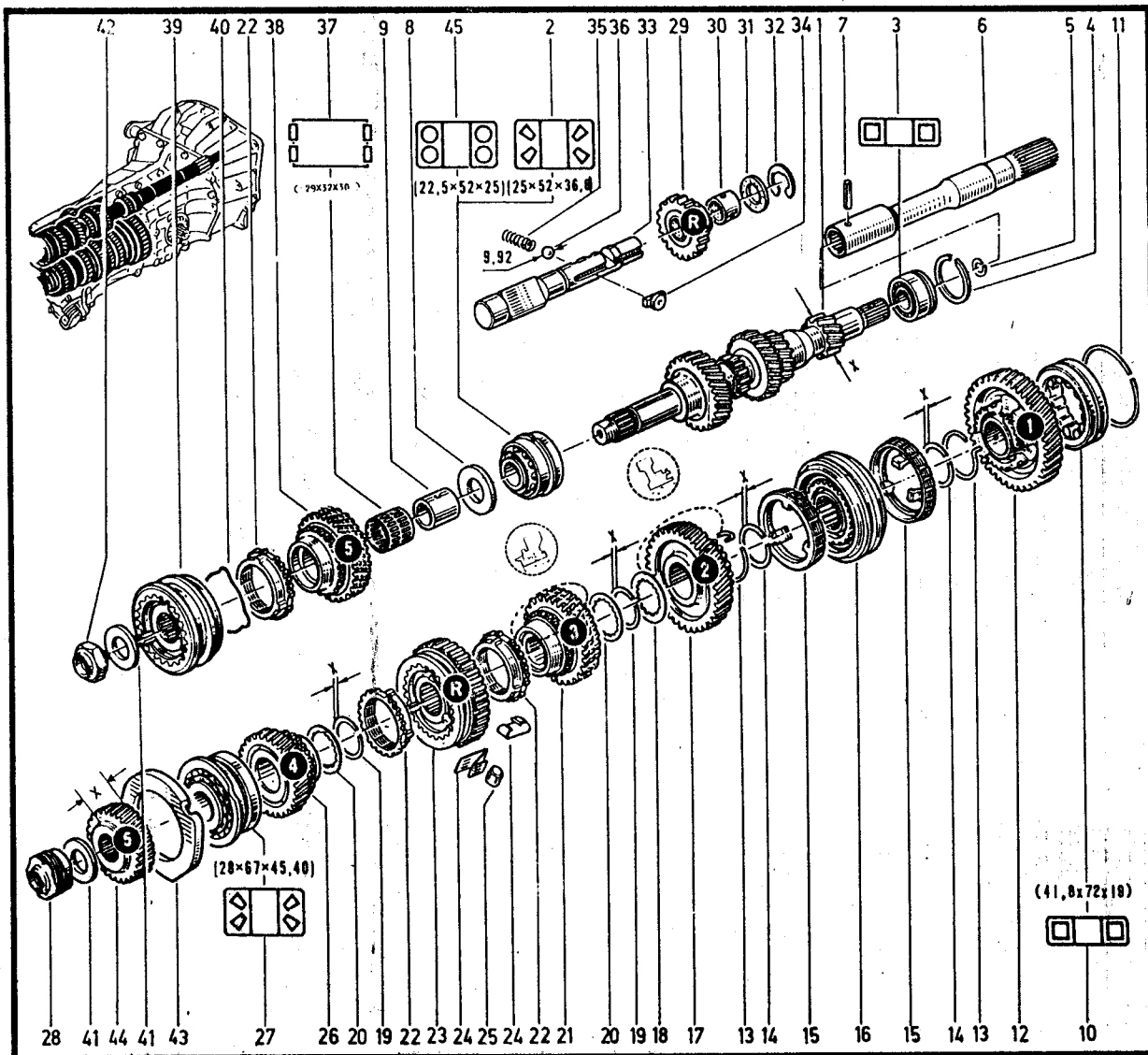

(a)	NG9-001	n° 9663	n°
	NG9-003	n° 4726	n°
	NG9-008	n° 6	n°
	NG9-009	n° 1	n°

(a) / NG9-001/008/009
 (b) / NG9-003

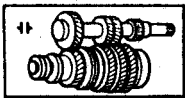

21.40.2
P.R. 1233

Injection

21.40.2
P.R. 1233

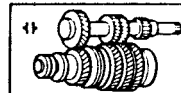

- 1- 77 02 096 346
- 2- 77 03 090 400
- 3- 77 03 090 256
- 4- 77 03 066 269
- 5- 77 03 055 015
- 6- 77 02 096 164
- 7- 77 03 067 009
- 8- 77 00 658 595
- 9- 77 00 679 059
- 10- 77 03 090 244
- 11- 77 03 066 192
- 12- 77 02 096 146
- 13- 05 56 112 500
- 14- 77 03 066 372
- 15- 77 00 725 747
- 16- 77 02 089 348
- 17- 77 02 096 295 (☆=37)
- 18- 77 00 721 375
- 19- 77 03 066 386
- 20- 77 00 721 374
- 21- 77 02 096 296
- 22- 77 00 708 152
- 23- 77 01 436 612
- 24- 77 00 685 833
- 25- 77 00 737 092
- 26- 77 00 667 703
- 27- 77 00 681 845 (☆=33)
- 28- 77 03 090 245
- 29- 77 02 096 142
- 30- 77 05 010 008
- 31- 77 01 348 472
- 32- 77 03 066 159
- 33- 77 00 732 219
- 34- 77 00 577 584
- 35- 77 05 015 147
- 36- 77 03 090 297
- 37- 77 03 090 261
- 38- 77 00 695 364 (☆=37)
- 39- 77 01 463 611
- 40- 77 00 656 205
- 41- 77 03 058 047
- 42- 77 03 040 028
- 43- 77 00 850 323
- 44- 77 02 096 001 (☆=30)

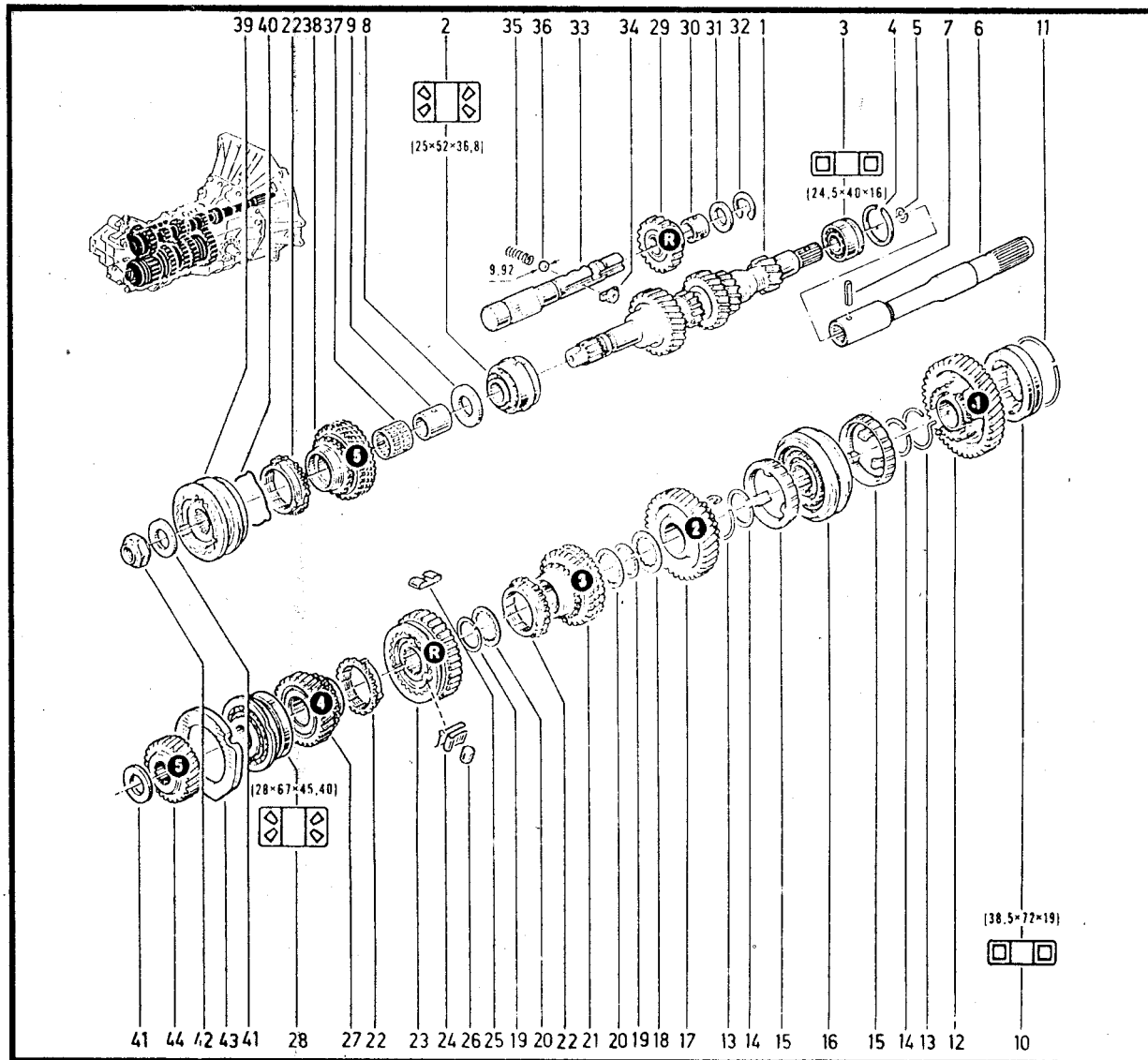

NG9-007
NG9-010
NG9-012

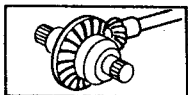

21.50

P.R. 1233

21.50

P.R. 1233

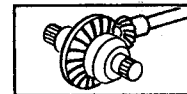

- 1- 77 02 089 431 (9x32)(a)⊞(84)
- 77 02 088 575 (9x34)(b)⊞ (163)
- 77 02 206 866 (a)(9x32)(x=2,82)(y=3,42)
- 77 02 206 865 (c)(9x34)(x=2,82)(y=3,42)
- 77 02 217 085 (c)(9x34)(x=2,82)(y=3,42)
- 2- 77 00 704 173
- 77 02 058 732
- 3- 77 02 096 153
- 4- 77 00 610 576 †
- 77 02 096 152
- 5- 77 00 656 300 †
- 77 02 096 155
- 6- 77 00 656 299 †
- 77 02 096 154
- 7- 77 00 680 444
- 8- 77 00 695 642
- 9- 77 00 673 183
- 10- 77 03 090 179
- 11- 77 03 065 128
- 12- 77 03 090 277

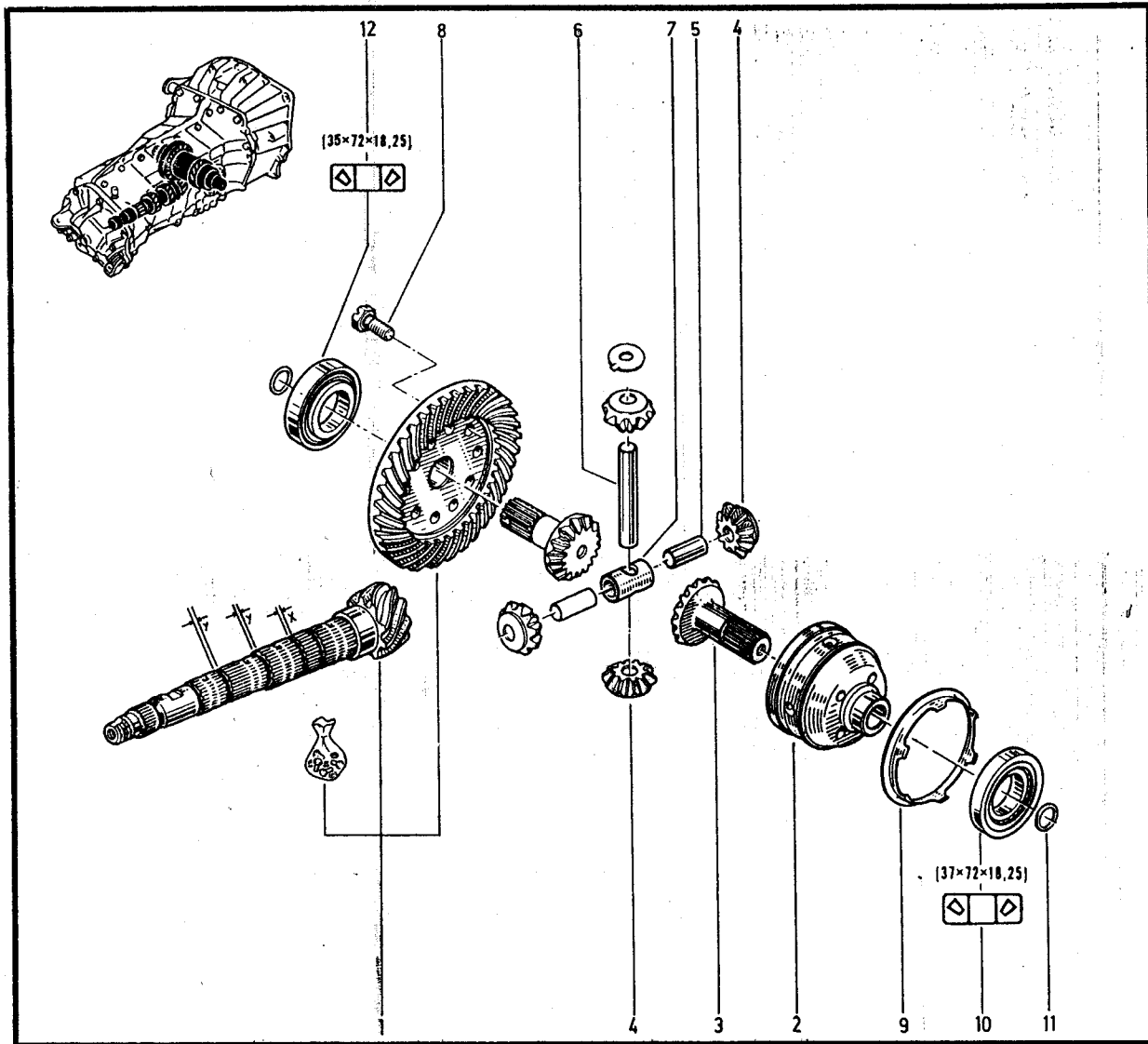

(a) /	⊞ NG9-000	n°	1	n°
	⊞ NG9-001	n°	1	n°
(b) /	⊞ NG9-003	n°	1	n°	4725
	⊞ NG9-003	n°	4726	n°
(c) /	⊞ NG9-009	n°	1	n°
	⊞ NG9-008	n°	6	n°

(84) ⊞ 7702206866-1
 (163) ⊞ 7702206865-1
 (163) ⊞ 7702096295-1
 (84) ⊞ 7702096296-1
 7703066386-1

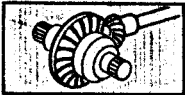

21.50.1
P.R. 1233

Injection

21.50.1
P.R. 1233

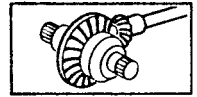

- 1- 77 02 217 085 (9x34) (x=2,82) (y=3,48)(b)
- 77 02 206 866 (9x32) (a)
- 2- 77 02 058 732
- 3- 77 02 096 153
- 4- 77 00 656 299 †
- 77 02 096 154
- 5- 77 02 096 152
- 6- 77 00 680 444
- 7- 77 00 656 300 †
- 77 02 096 155
- 8- 77 02 096 152
- 9- 77 00 695 642 (x=12)
- 10- 77 00 673 183
- 11- 77 03 090 179
- 12- 77 03 090 277
- 13- 77 03 065 128
- 14- 77 00 707 307
- 15- 77 00 726 630 (☆ =18)
- 16- 77 00 679 331
- 17- 77 03 087 117

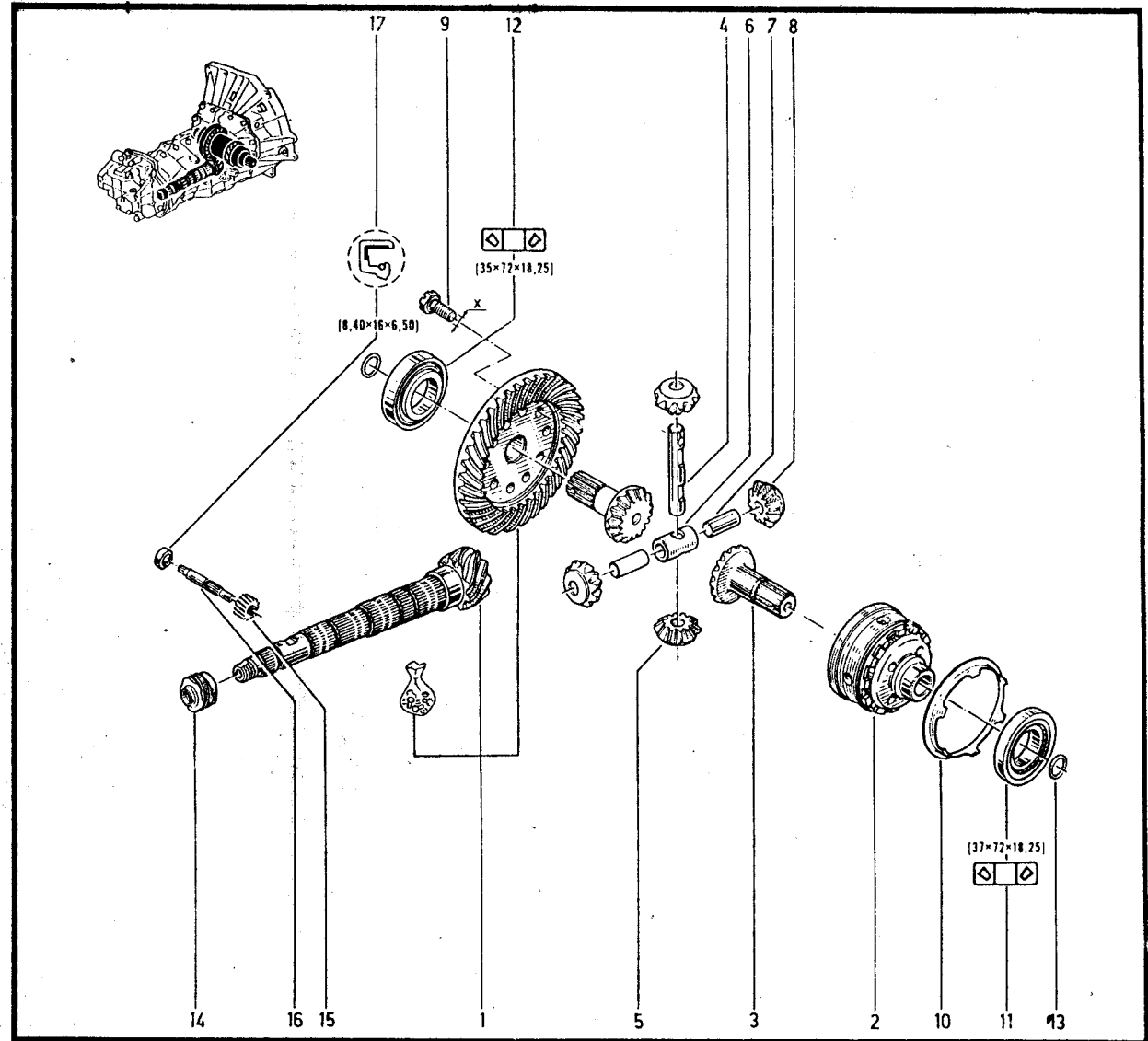

(a) ГЛНГ9-007
(b) ГЛНГ9-010
ГЛНГ9-012

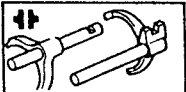

21.60

P.R. 1233

21.60

P.R. 1233

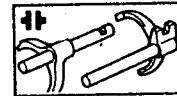

- 1- 77 00 719 523 (a)
- 77 00 719 559 (b)
- 2- 77 03 067 082
- 3- 77 00 723 918
- 4- 77 00 723 917
- 5- 77 03 057 050
- 6- 77 05 015 147
- 7- 77 03 090 297
- 8- 77 01 463 875
- 9- 77 00 723 794
- 10- 06 07 650 500
- 11- 77 00 740 195
- 12- 77 03 067 081
- 13- 77 00 735 860
- 14- 77 00 721 483
- 15- 77 01 202 100
- 16- 77 05 015 117
- 17- 77 03 067 137
- 18- 77 03 067 030
- 19- 77 03 075 059
- 20- 77 05 015 147
- 21- 77 05 075 127
- 22- 77 00 732 043
- 23- 77 05 015 174
- 24- 77 03 067 259
- 25- 77 00 724 004
- 26- 77 03 065 037
- 27- 77 00 679 022
- 28- 77 03 090 215
- 29- 77 00 855 243
- 30- 77 03 061 131
- 31- 77 03 067 069
- 32- 77 03 087 179
- 33- 77 04 001 363
- 34- 77 03 087 117
- 35- 77 00 679 331
- 36- 77 00 726 630 (☆=18) -
- 77 00 726 631 (☆=19)(c) -
- 77 02 096 178 (☆=20)(d) -

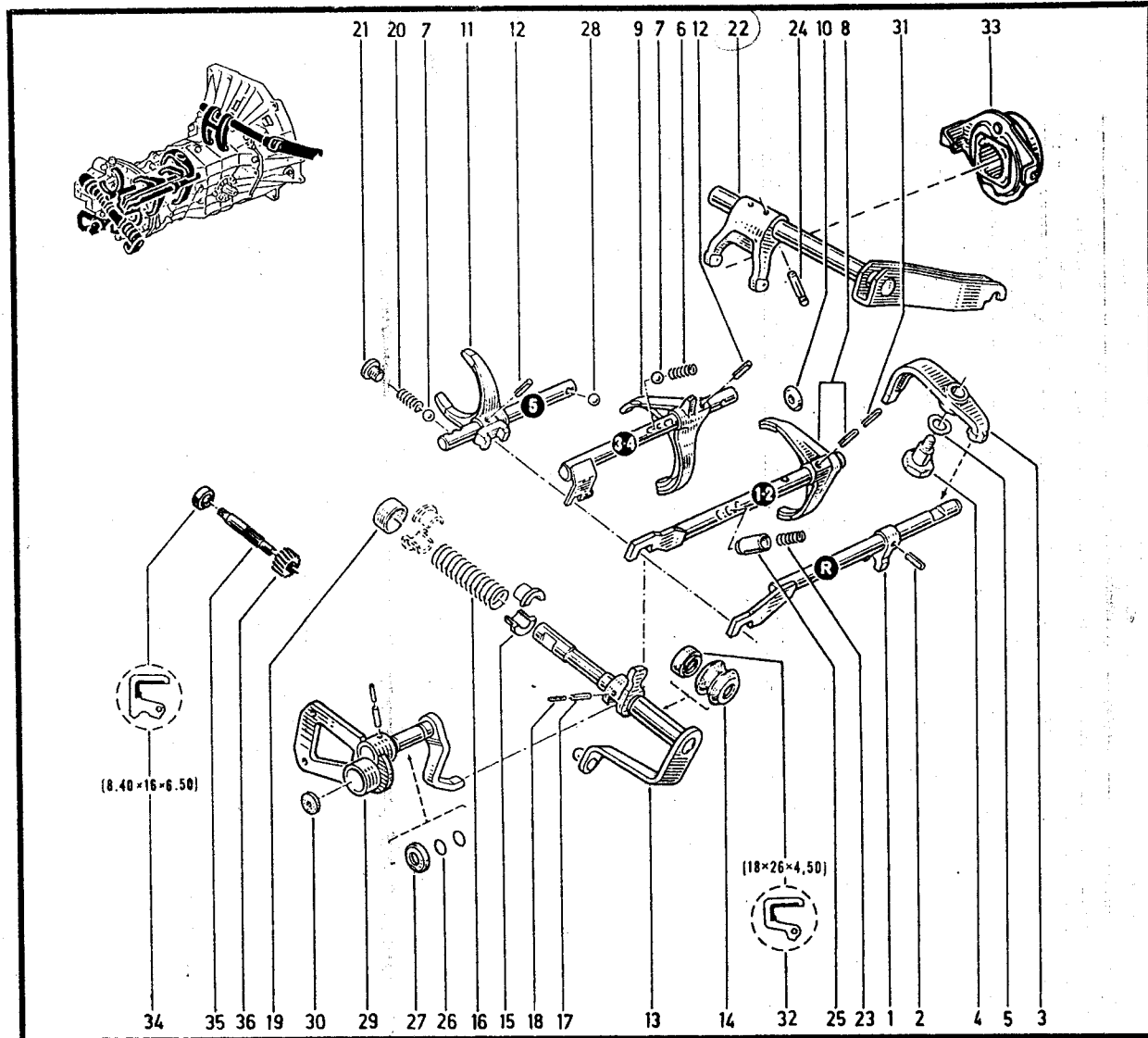

(a) /	NG9-001	n°	1	⇒ n° 5933
	NG9-003	n°	1	⇒ n° 3077
(b) /	NG9-001	n°	5934	⇒ n°
	NG9-003	n°	3077	⇒ n°
	NG9-007	n°	1	n°
	NG9-009	n°	1	n°
	NG9-010	n°	1	n°

(c) /	NG9-009	n°	1	n°
	NG9-012	n°	1	n°
(d) /	NG9-010	n°	1	n°

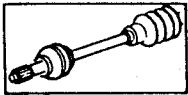

29.01

P.R. 1233

29.01

P.R. 1233

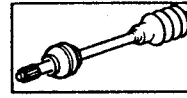

- 1- 77 00 762 798
- 2- 77 01 466 172
- 3- 77 01 035 088 (18)
- 77 01 034 800 (15)(x=24)(y=87)
- 4- 79 03 067 016
- 5- 08 54 329 100
- 6- 77 00 776 760 (x=5)

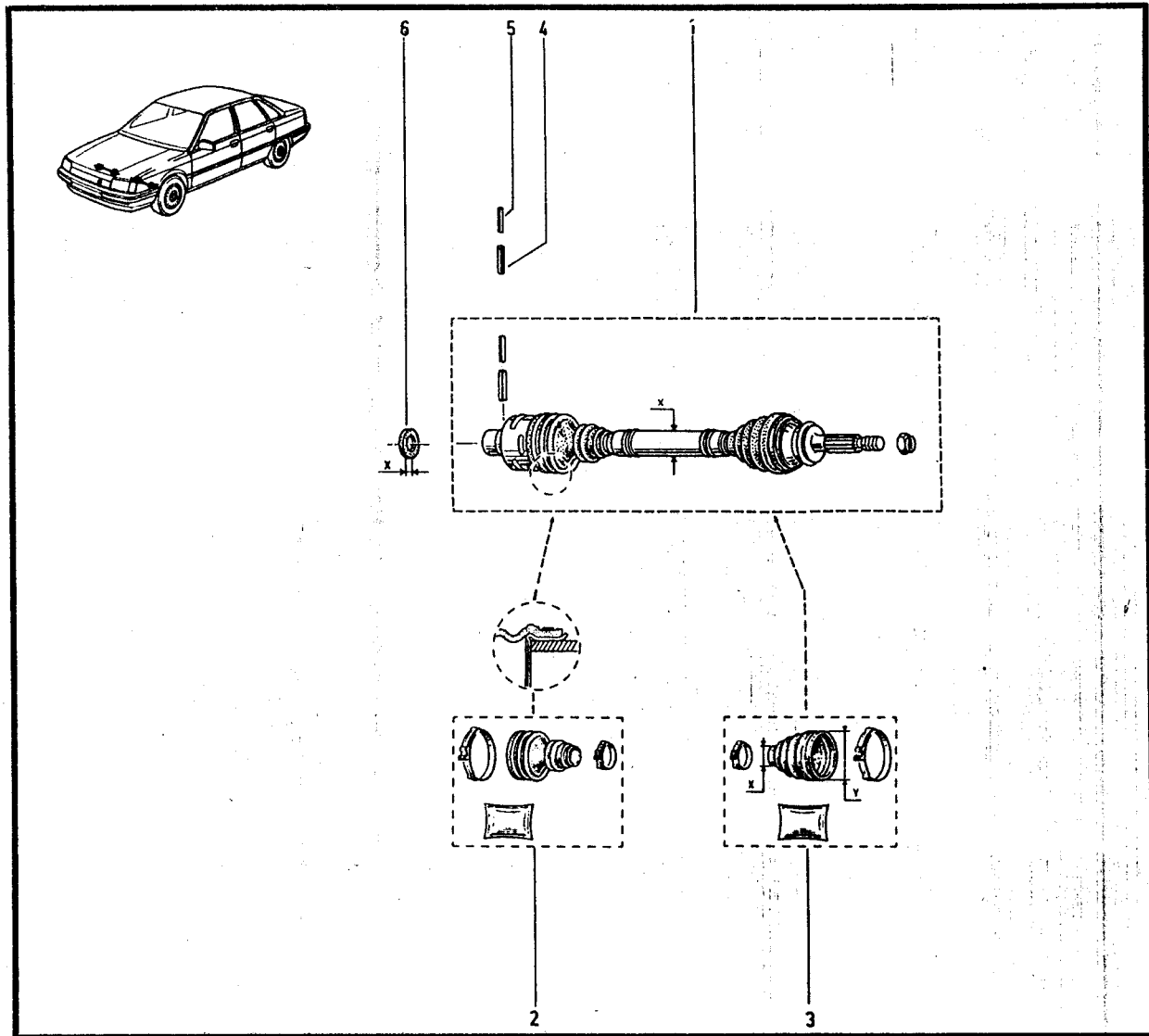

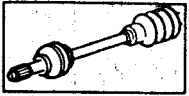

29.02
P.R. 1233

(ABS)

29.02
P.R. 1233

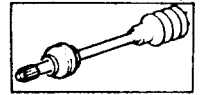

- 1- 77 01 349 921
- 2- 77 01 465 911
- 3- 77 01 466 172
- 4- 77 01 035 380 (x=28)(y=90)
- 5- 77 00 739 663

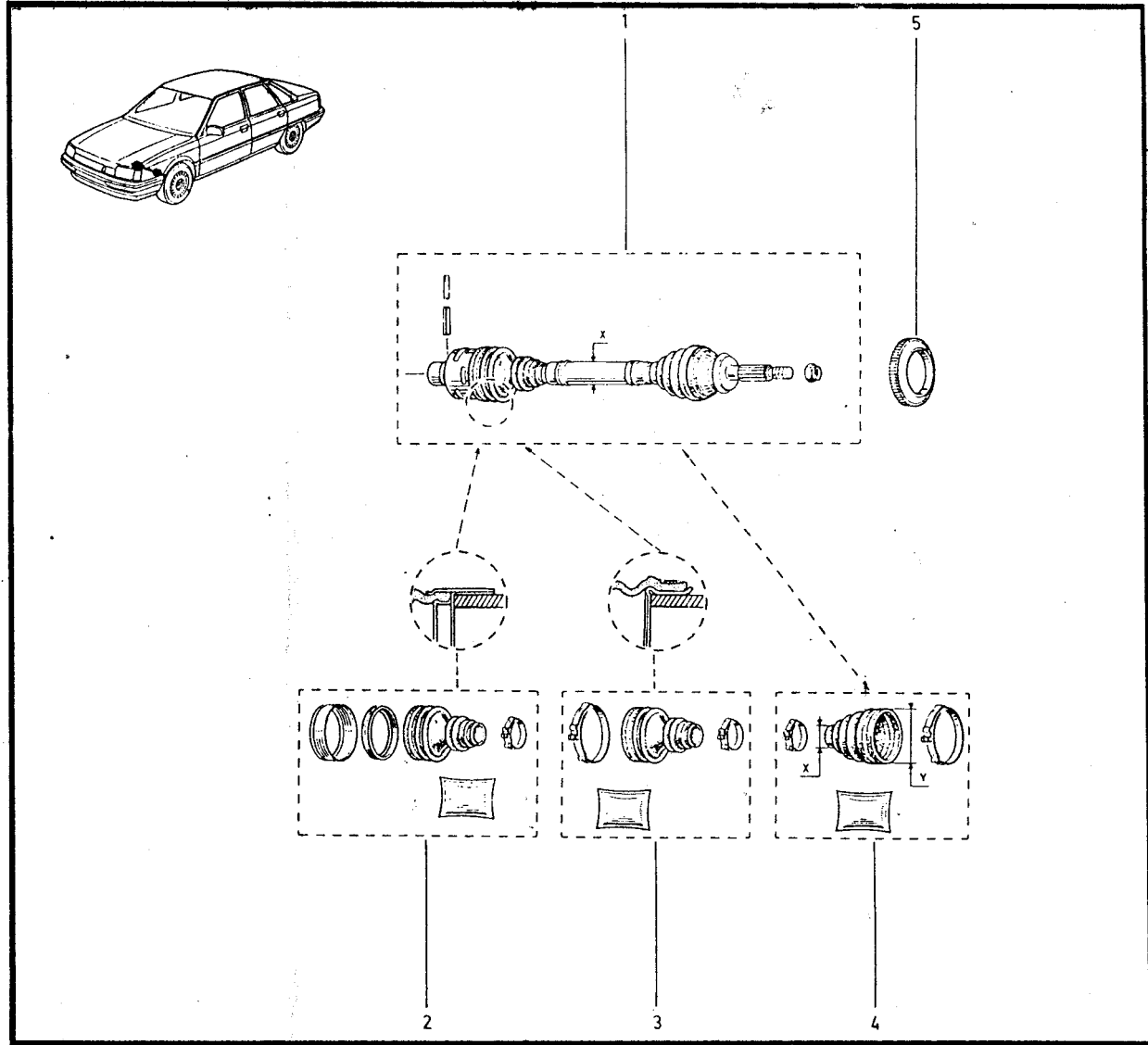

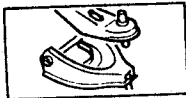

31.01

P.R. 1233

31.01

P.R. 1233



- 1- 77 00 776 393
- 2- 77 03 101 200
- 3- 77 03 053 649
- 4- 77 00 767 686
- 5- 77 03 053 649
- 6- 77 03 034 115
- 7- 77 00 760 487
- 8- 77 00 767 684
- 9- 77 00 764 195
- 10- 77 02 094 975
- 11- 77 00 754 515
- 12- 77 00 777 276
- 13- 77 00 763 539
- 14- 77 02 094 976
- 15- 77 00 777 295 [e]
- 16- 77 00 781 316
- 17- 77 03 001 373
- 18- 77 03 055 011
- 19- 79 03 053 043
- 20- 77 00 787 021
- 21- 50 03 101 239
- 22- 77 03 053 015
- 23- 77 03 101 147
- 24- 77 00 763 315
- 25- 77 03 034 098
- 77 03 034 114
- 26- 77 00 772 926
- 27- 77 02 094 498

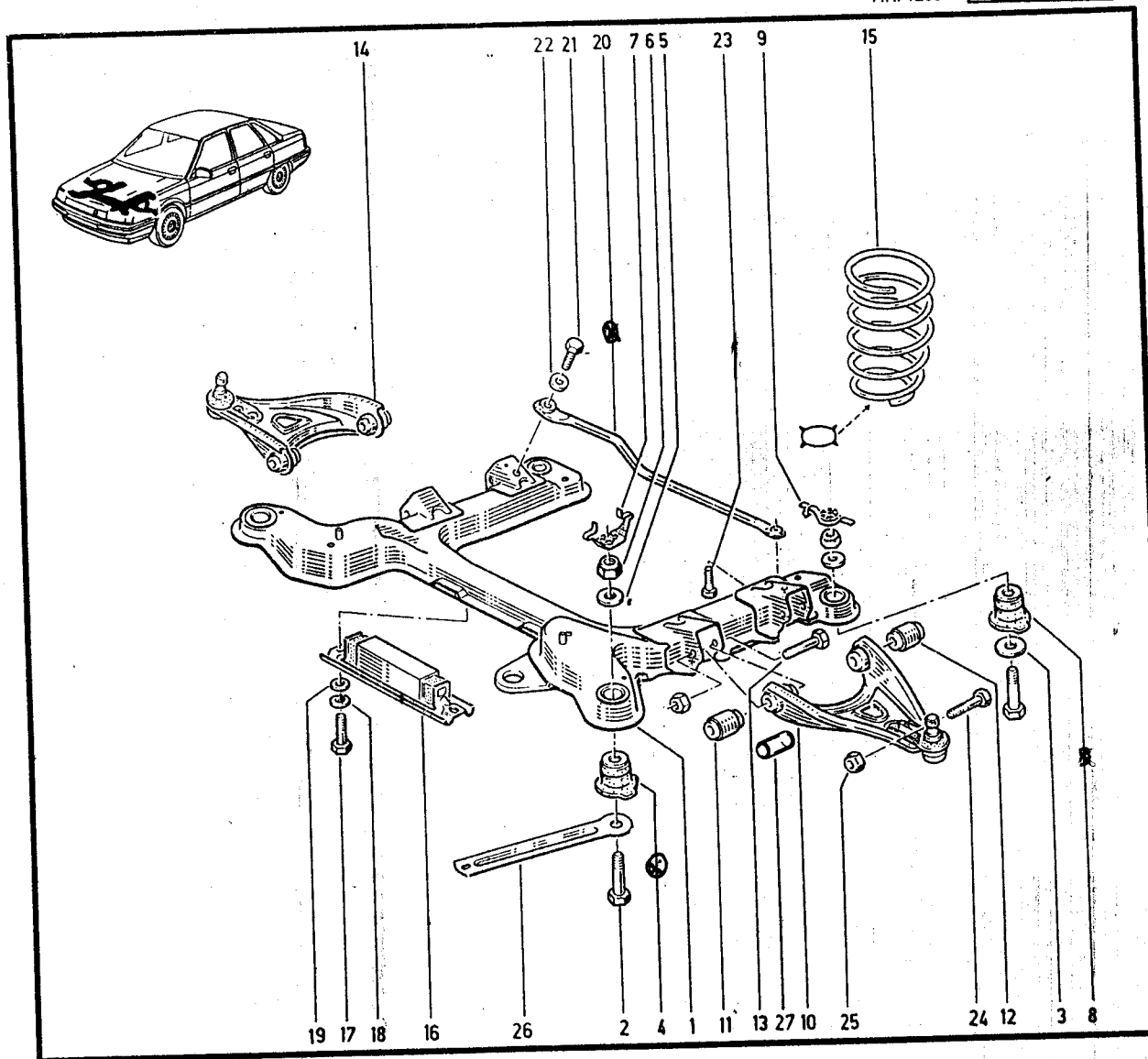



31.30
P.R. 1233

1-77 01 464 037

31.30
P.R. 1233

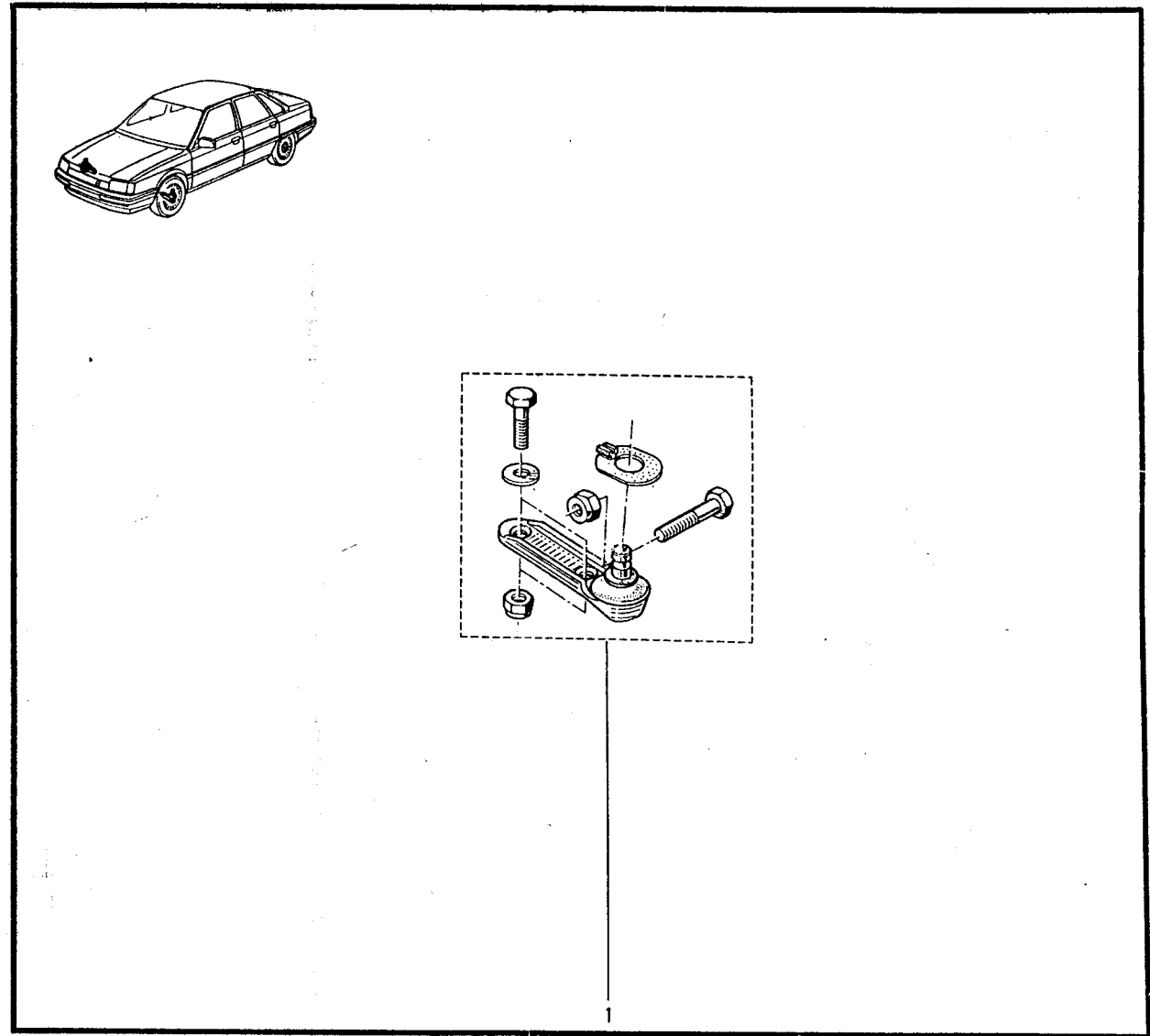
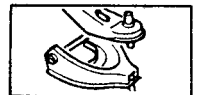



31.40

P.R. 1233

- 1-77 00 763 682
- 2-77 03 055 035
- 3-77 03 007 158
- 4-77 00 662 816
- 5-77 00 715 149
- 6-77 00 764 193
- 7-77 03 004 128
- 8-77 00 710 507
- 9-77 03 034 068
- 10-77 00 763 683
- 11-77 01 464 020 †
- 77 01 462 020
- 12-77 00 774 128
- 13-77 00 774 127

31.40

P.R. 1233

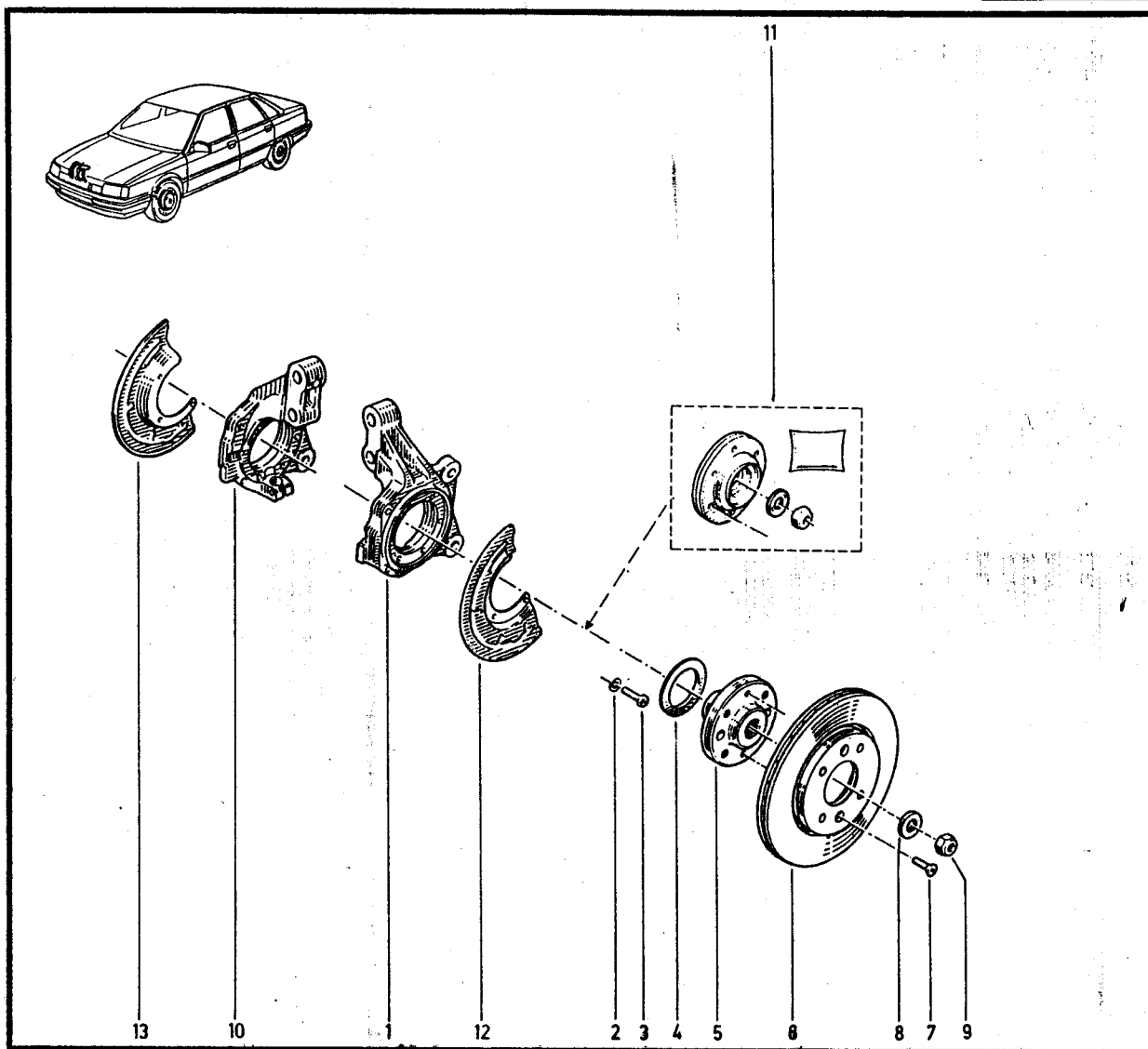



32.01

12.84 P.R. 1233

32.01

P.R. 1233



- 1- 77 00 802 381 十# (20)
- 77 02 217 429 # (A)
- 2- 77 00 757 686
- 3- 79 03 053 061
- 4- 77 03 034 062
- 5- 77 02 094 255
- 6- 77 00 757 131 9200795186
- 7- 77 02 094 775
- 8- 77 00 797 666
- 9- 77 00 757 691
- 10- 77 02 095 120
- 11- 77 01 028 077
- 12- 79 03 053 043
- 13- 77 03 055 011
- 14- 77 03 001 800
- 15- 77 00 802 382 十# (21)
- 77 02 217 430 # (A)
- 16- 77 02 094 776
- 17- 77 00 776 182
- 77 00 771 094 (ABS)
- 18- 77 03 101 034
- 19- 77 02 094 459
- 20- 77 04 002 011
- 21- 77 02 094 770
- 22- 77 02 094 771

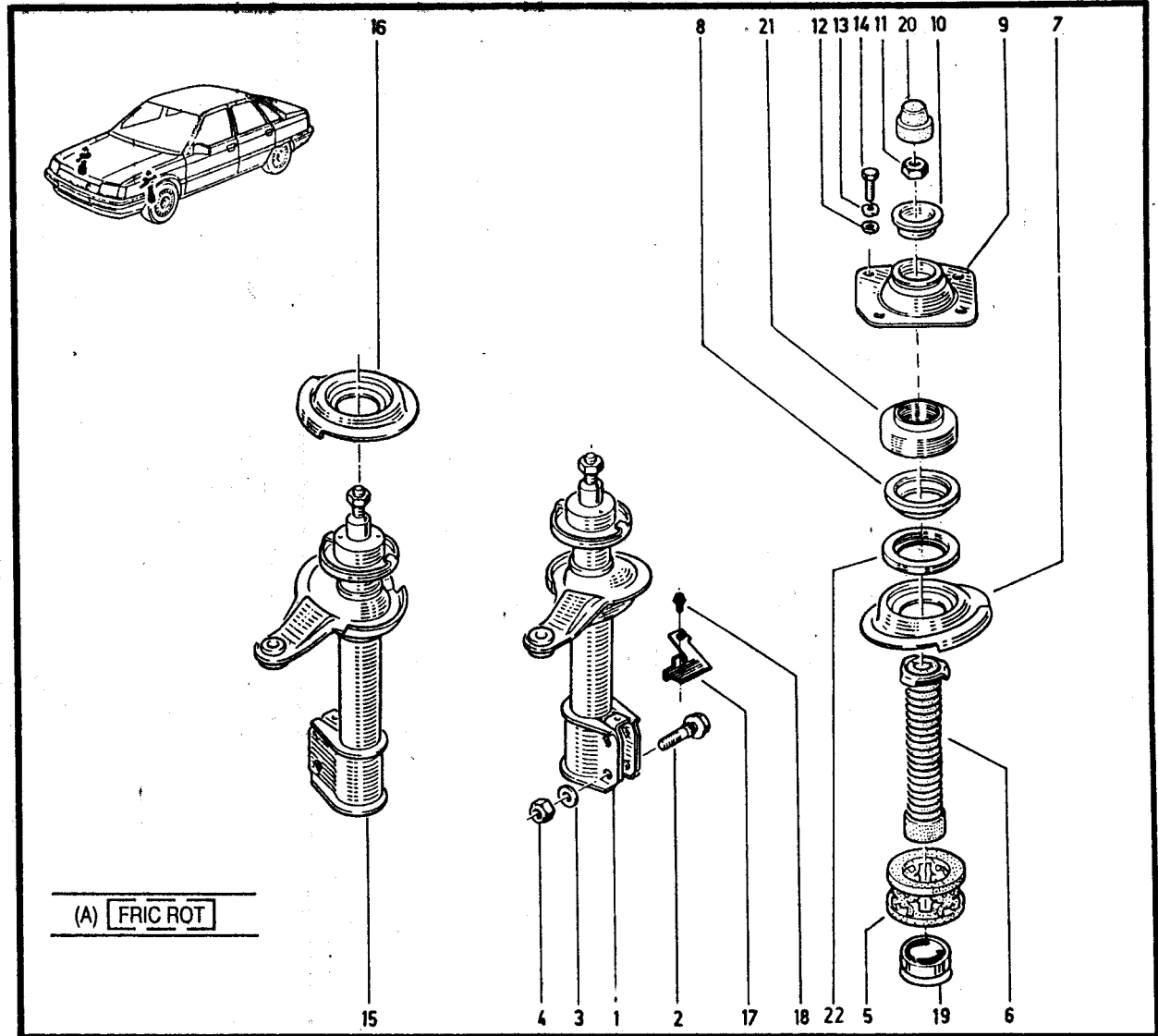

- (20) 7702217430-1
- (21) 7702217429-1

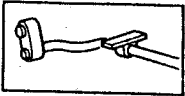

32.10
P.R. 1233

32.10
P.R. 1233



- 1- 77 02 206 702
- 2- 77 00 774 026
- 3- 77 00 774 027
- 4- 79 03 053 043
- 5- 77 03 055 021
- 6- 77 03 001 373
- 7- 77 03 044 113
- 8- 77 02 094 972 (B=20)
- 9- 77 00 771 568
- 10- 77 00 771 569
- 11- 77 02 206 702
- 77 02 217 125 (B=20)

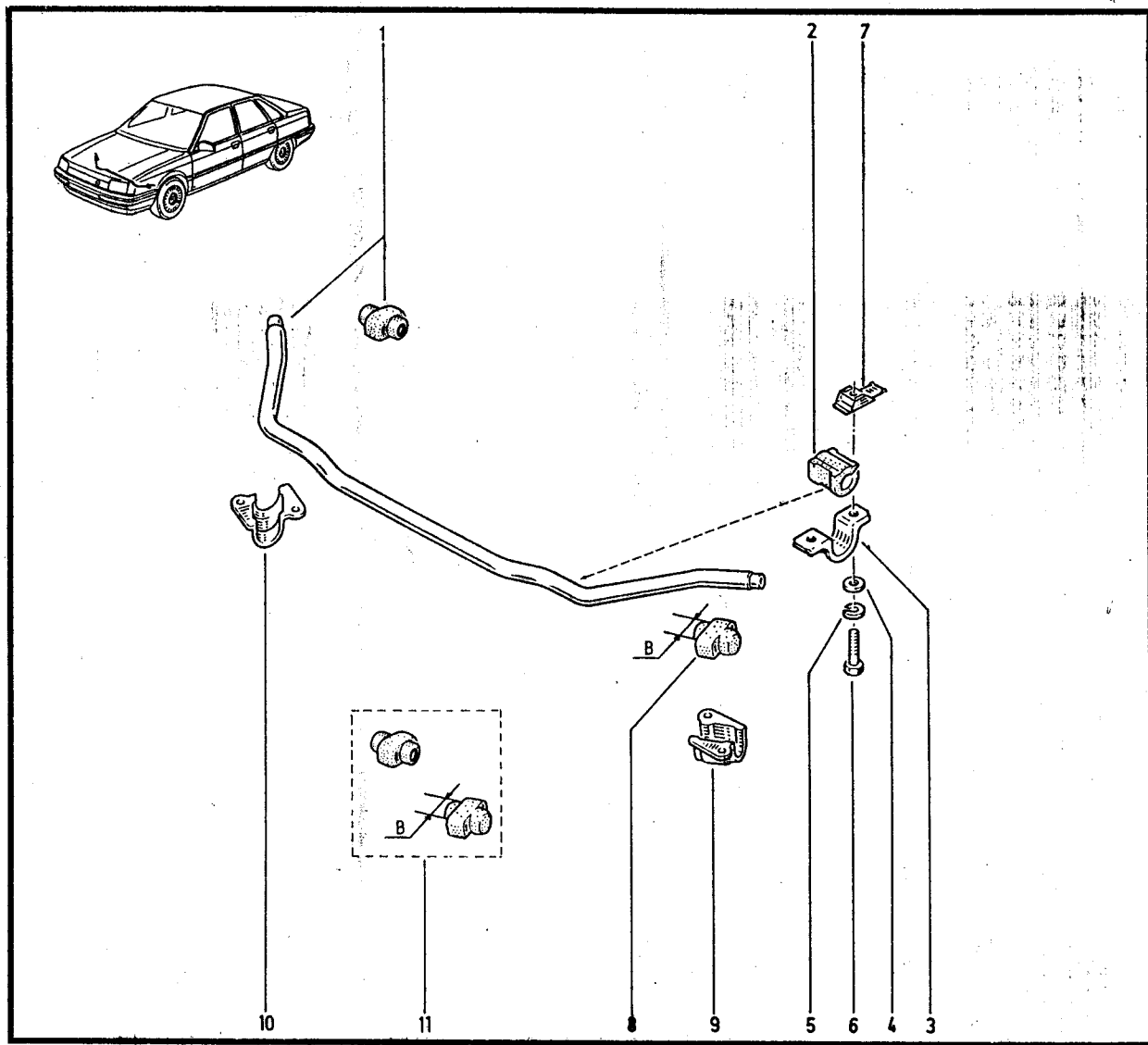

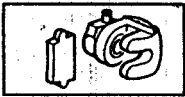

32.30
P.R. 1233

32.30
P.R. 1233

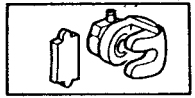

- 1- 77 02 206 160
- 77 01 032 008
- 2- 77 03 101 091
- 3- 77 02 206 164
- 77 01 202 476
- 4- 77 01 204 087 (T424)+
- 77 01 203 069 (T424)
- 5- 77 02 206 161
- 77 01 203 073
- 6- 77 02 206 166
- 77 01 348 674
- 7- 77 02 206 163
- 77 01 202 479
- 8- 77 02 206 165
- 77 01 202 480
- 9- 77 02 206 162
- 77 01 203 074

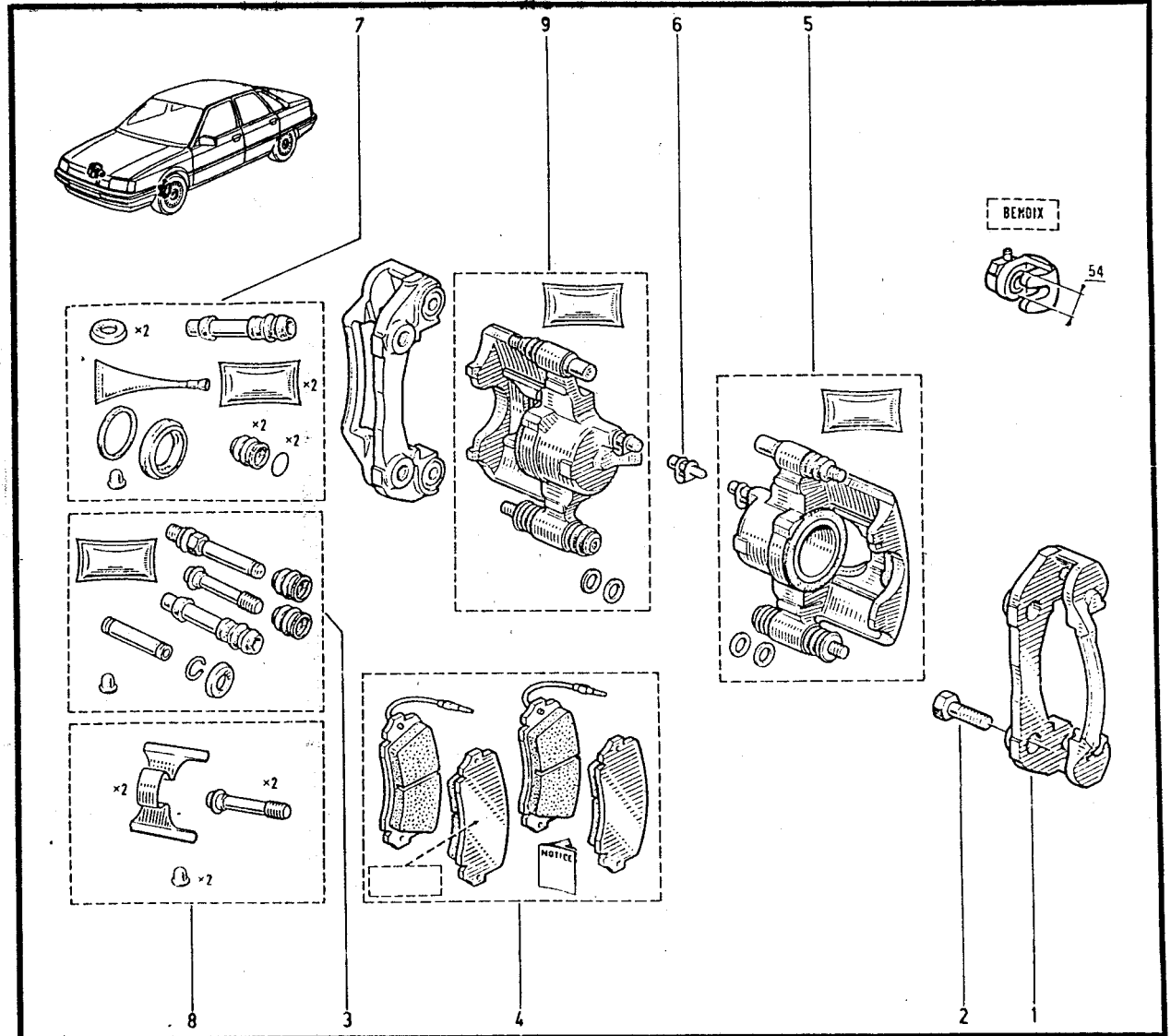



33.40
P.R. 1233

- 1- 77 00 777 497
- 2- 77 00 710 511
- 3- 77 03 034 118
- 4- 77 00 754 338
- 5- 77 03 009 128
- 6- 77 04 002 263

33.40
P.R. 1233

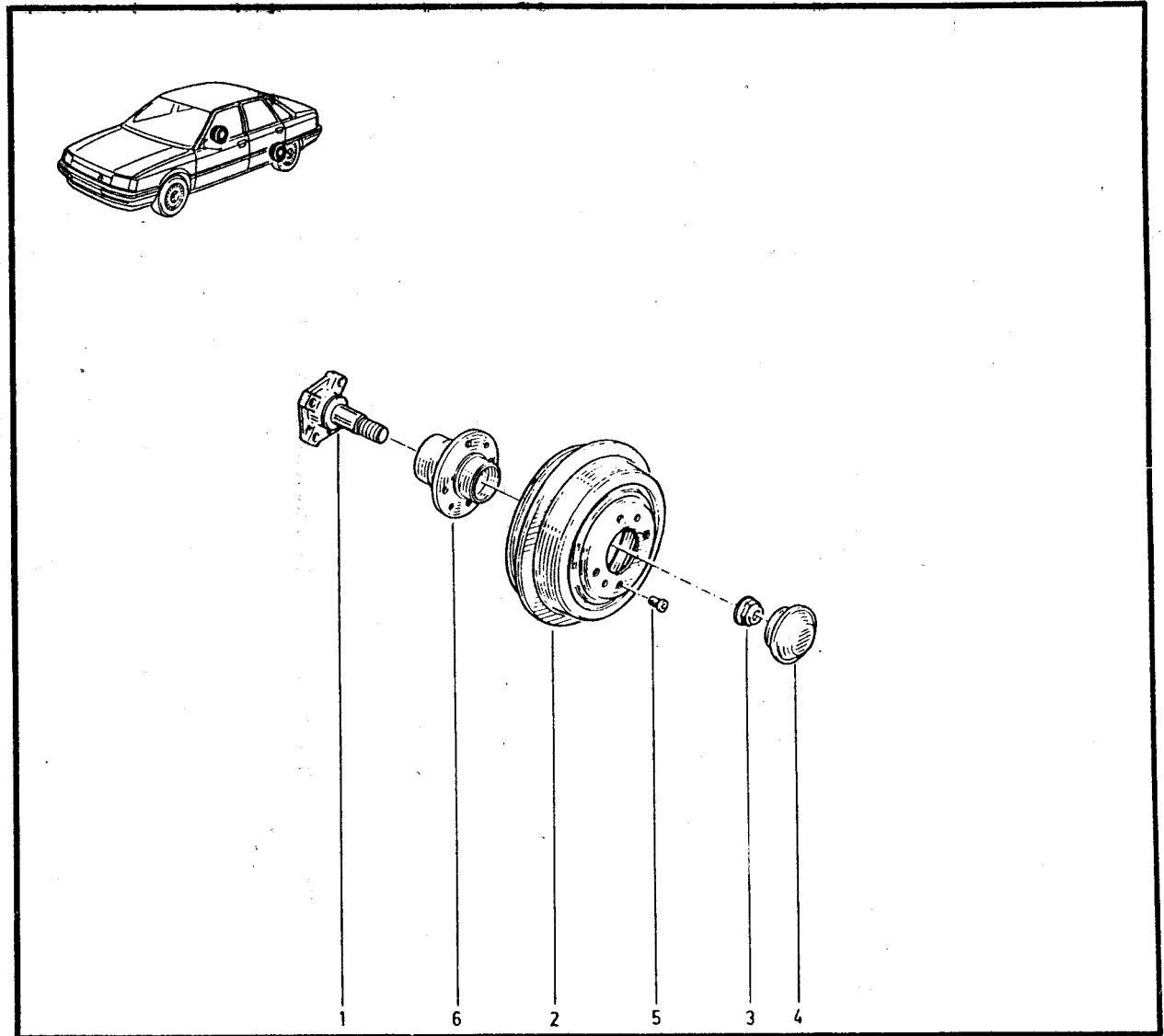
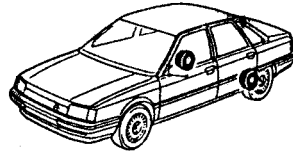

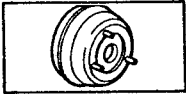

33.41.1

P.R. 1233

(ABS)

33.41.1

P.R. 1233



- 1- 77 00 813 640
- 2- 77 00 780 921
- 3- 77 00 764 192
- 4- 77 03 004 128
- 5- 77 03 034 118
- 6- 77 00 754 338
- 7- 77 00 813 642

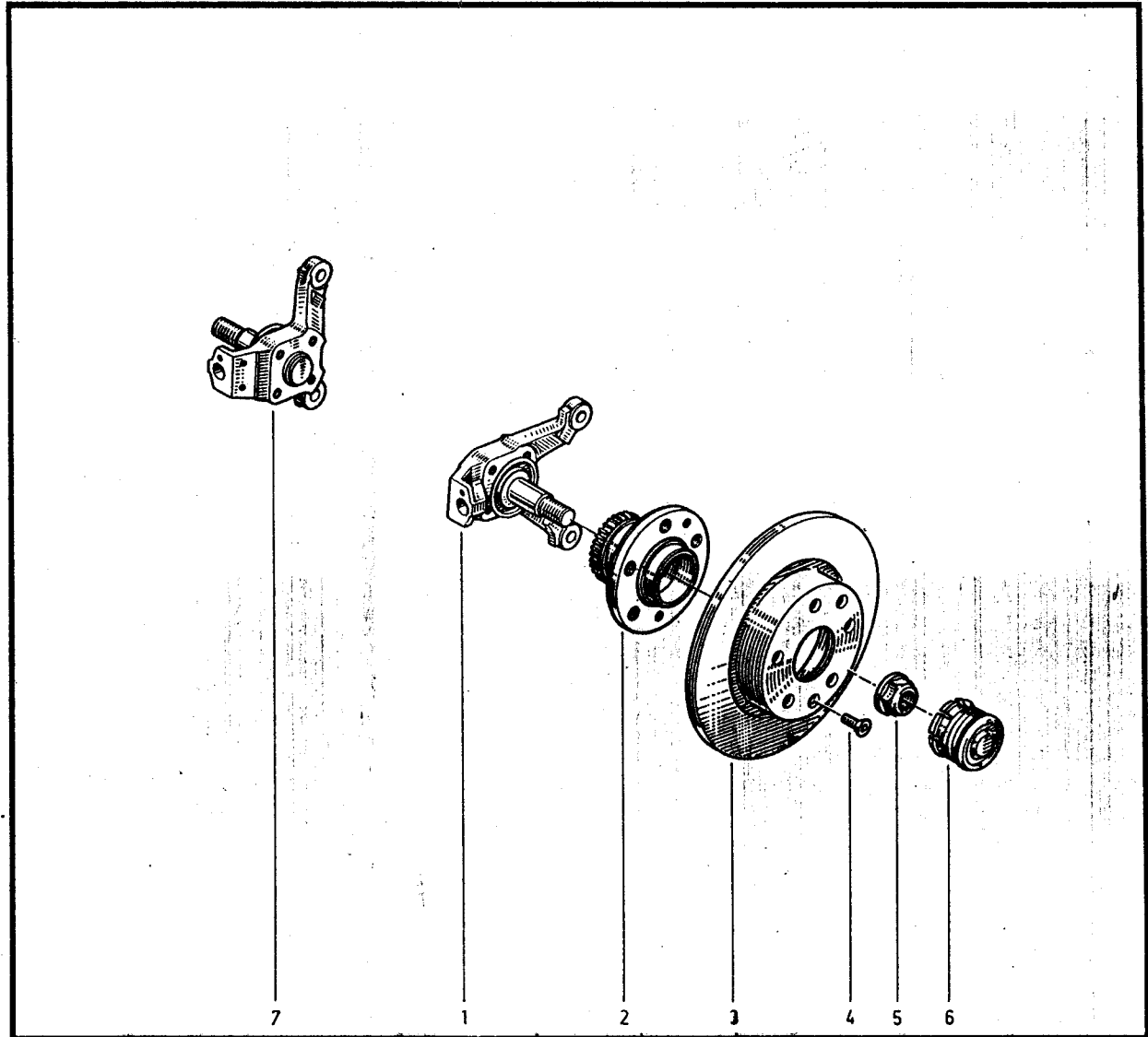



33.60

P.R. 1233

- 1- 77 00 743 524 (x=21) (a)
- 77 00 762 272 (x=22,5) (b)
- 2- 77 00 743 525 (x=21) (a)
- 77 00 762 273 (x=22,5) (b)

33.60

P.R. 1233

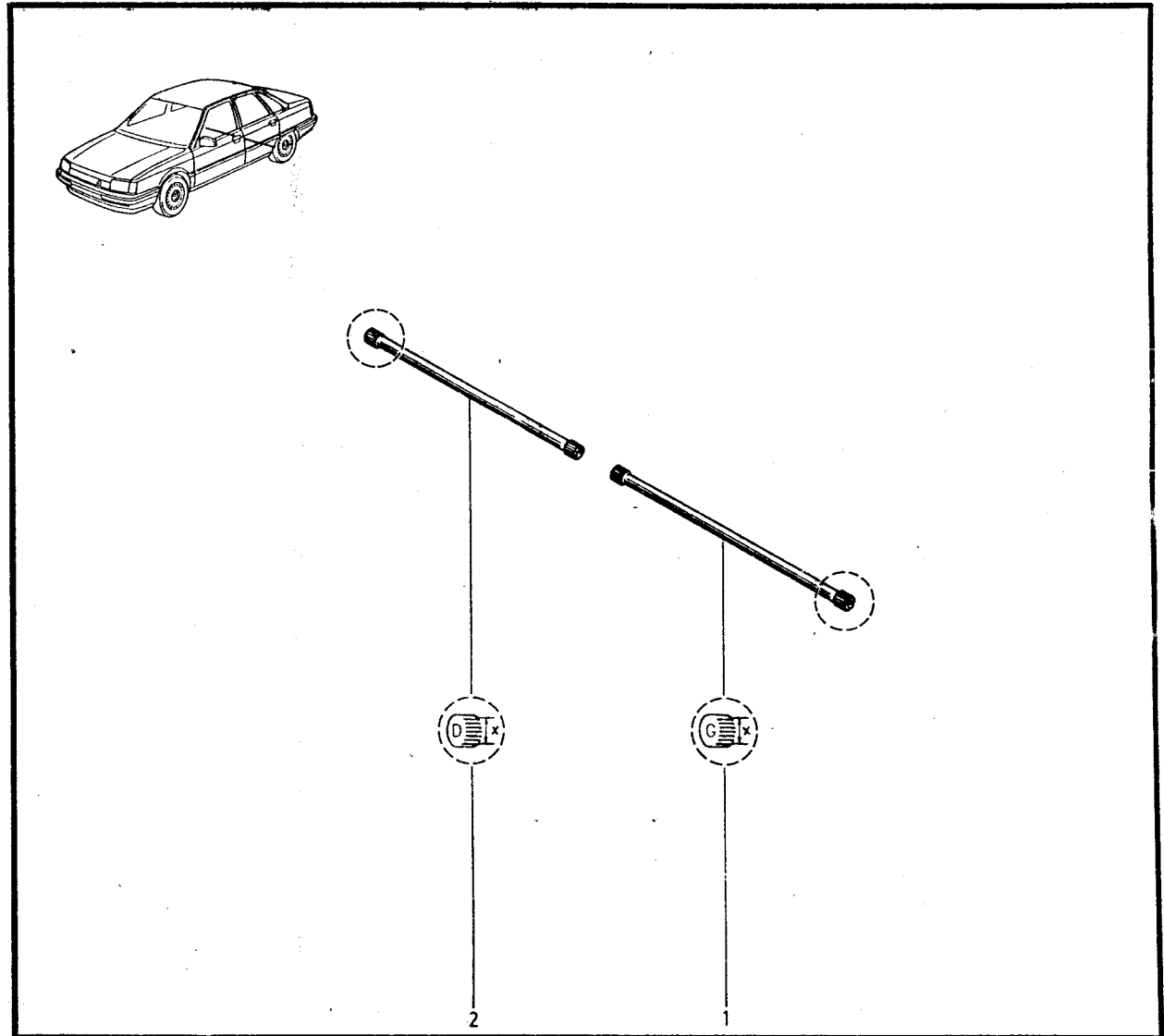
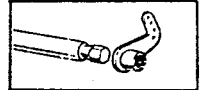

- K48S 090/091
- L48Z 091/095/096
- L48X 208
- (a) L488 089
- L48Y 091/090
- L48K 209
- L48G 202

- K48S 090/092
- K48Y 090/092
- (b) K488 089-K487
- K48X 210
- K48G 202



34.01

P.R. 1233

34.01

P.R. 1233



- 1- 77 00 801 742
- 2- 77 03 101 252
- 3- 79 03 053 114
- 4- 77 03 101 065
- 5- 77 03 053 445

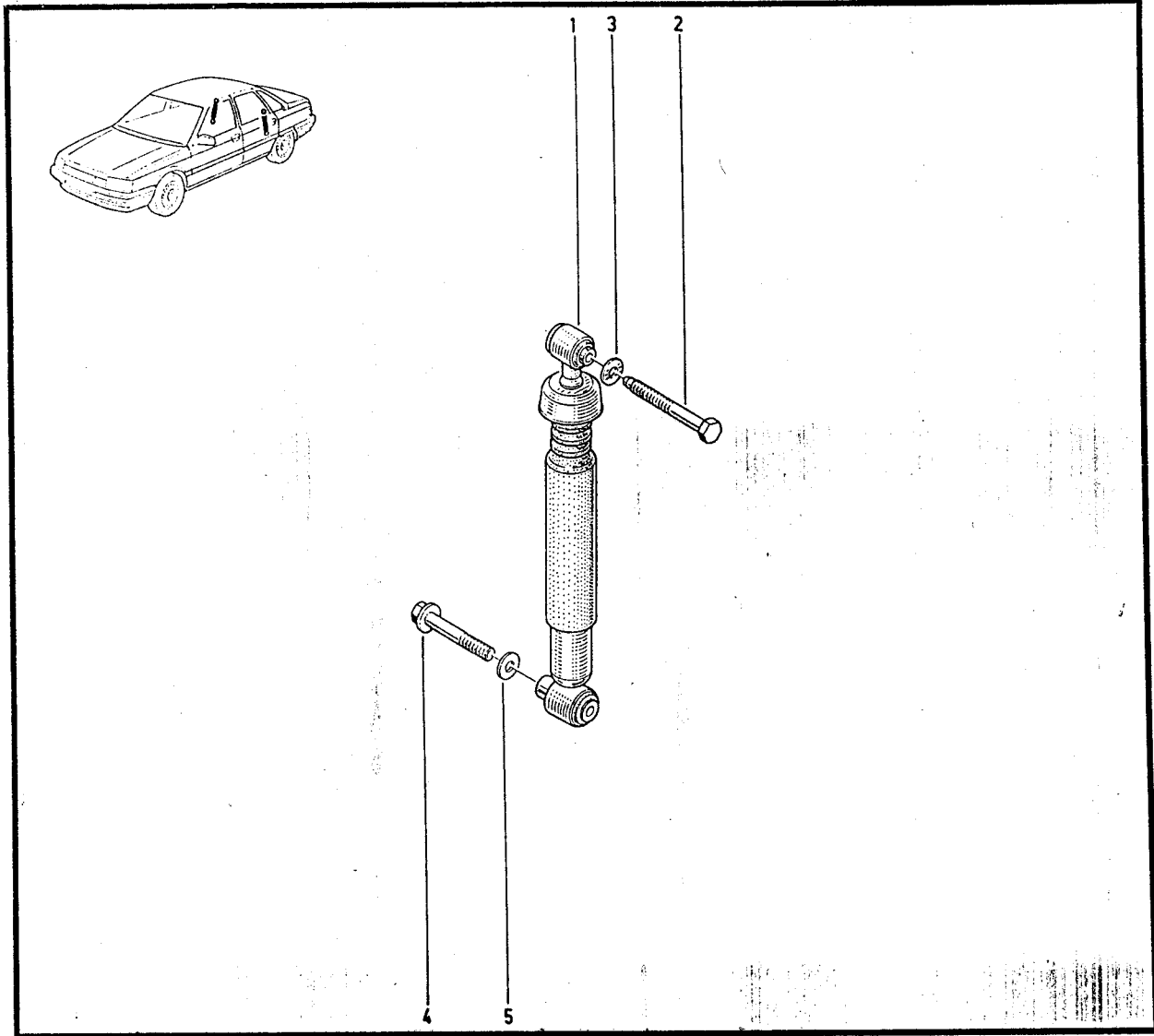

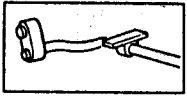

34.10
P.R. 1233

- 1 - 77 00 699 009 (x=15)
- 2 - 77 03 101 055
- 3 - 79 03 053 050
- 4 - 77 00 681 260

34.10
P.R. 1233

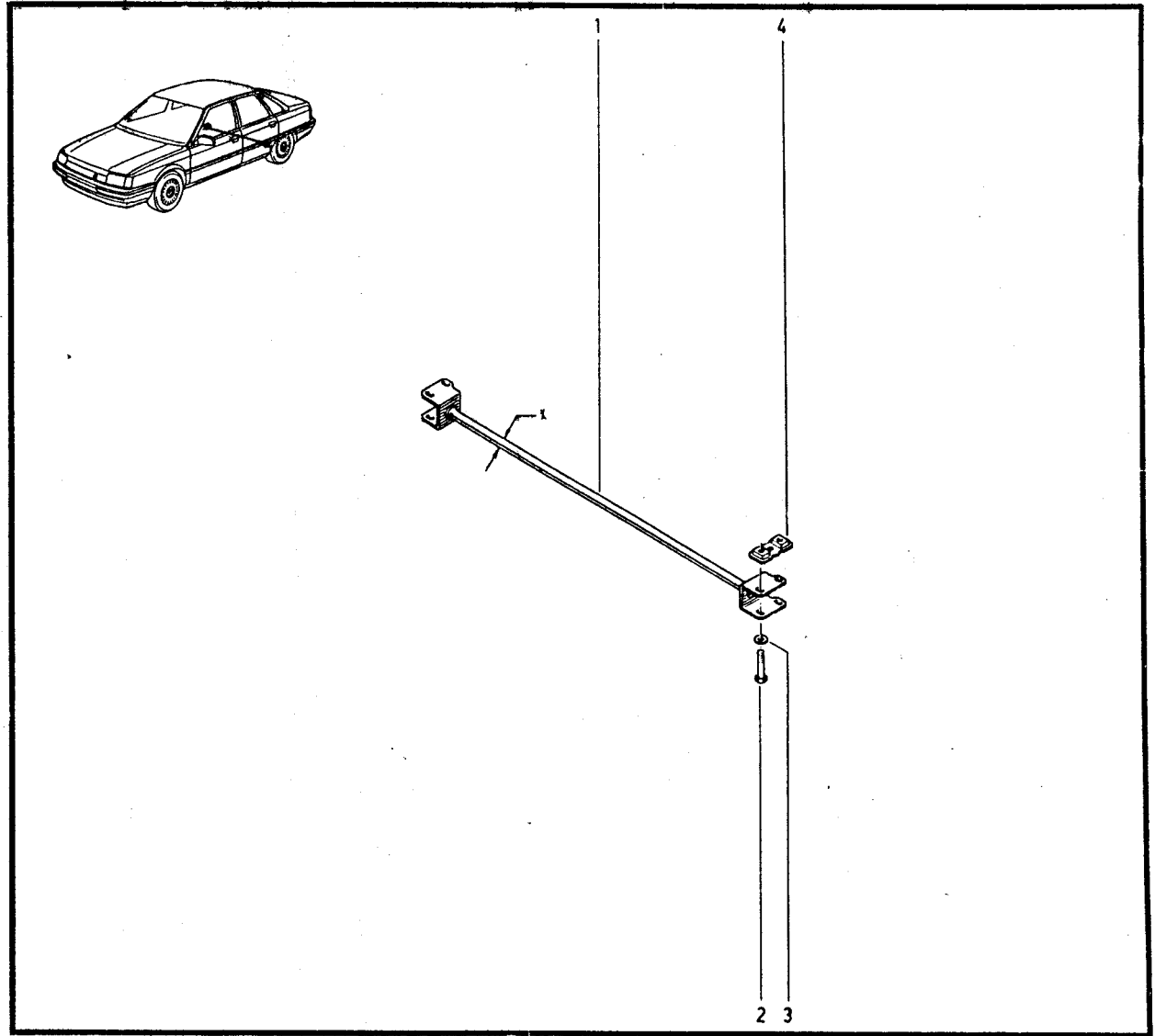
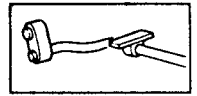



34.30

P.R. 1233

34.30

P.R. 1233



- 1- 77 01 033 415
- 2- 77 01 349 928 (F610/D242)†
- 77 01 202 381 (E558)
- 3- 77 01 202 380
- 4- 77 01 202 382
- 5- 77 01 202 385
- 6- 77 01 033 416
- 7- 77 03 007 154
- 8- 77 00 762 039

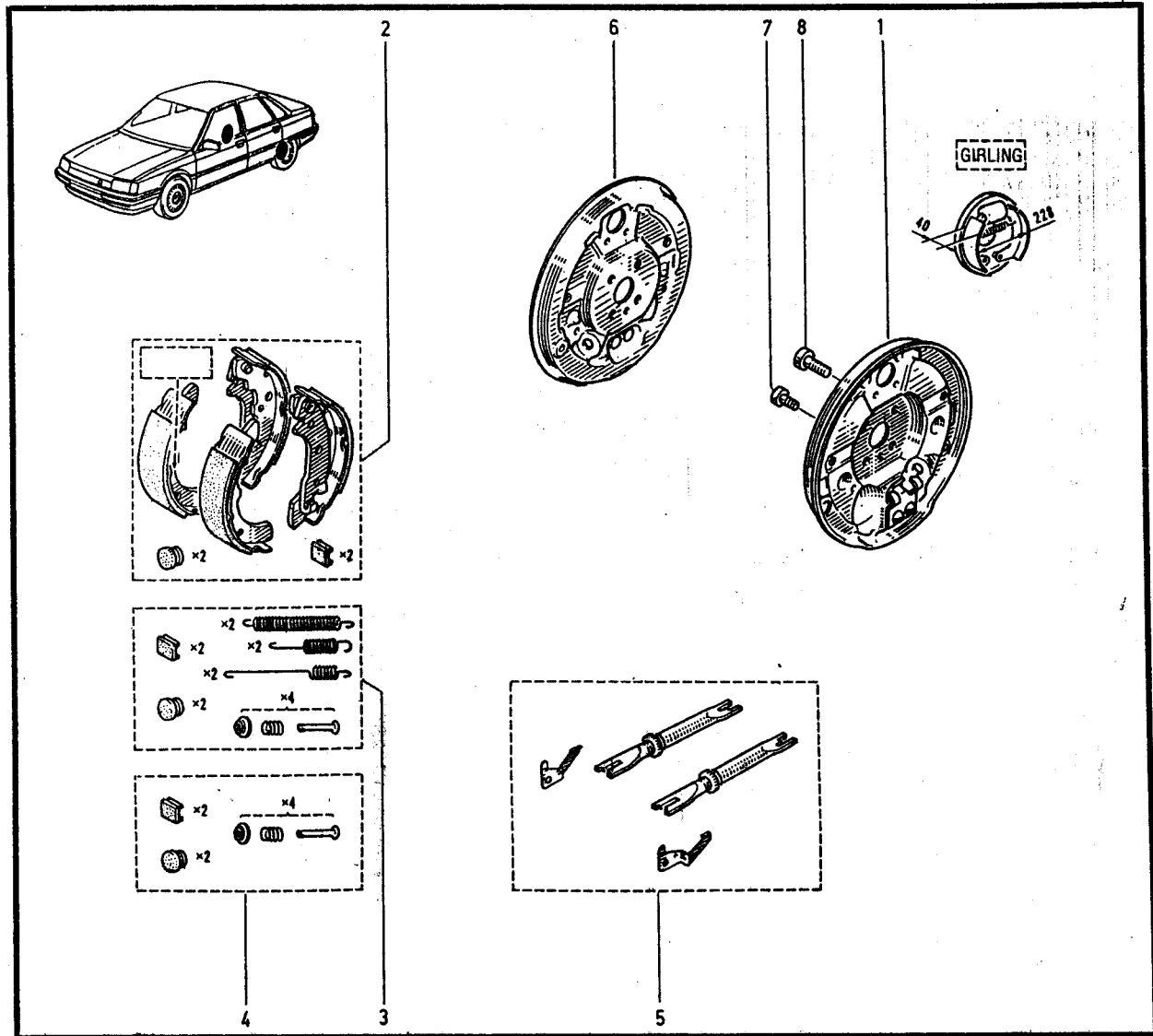



34.34.1

P.R. 1233

(ABS)

34.34.1

P.R. 1233



- 1-77 01 203 123
- 2-77 01 203 125
- 3-77 01 203 633 (F114)
- 4-77 01 203 418
- 5-77 01 203 416
- 6-77 01 203 419
- 7-77 01 203 417
- 8-77 00 797 979
- 9-77 00 797 980

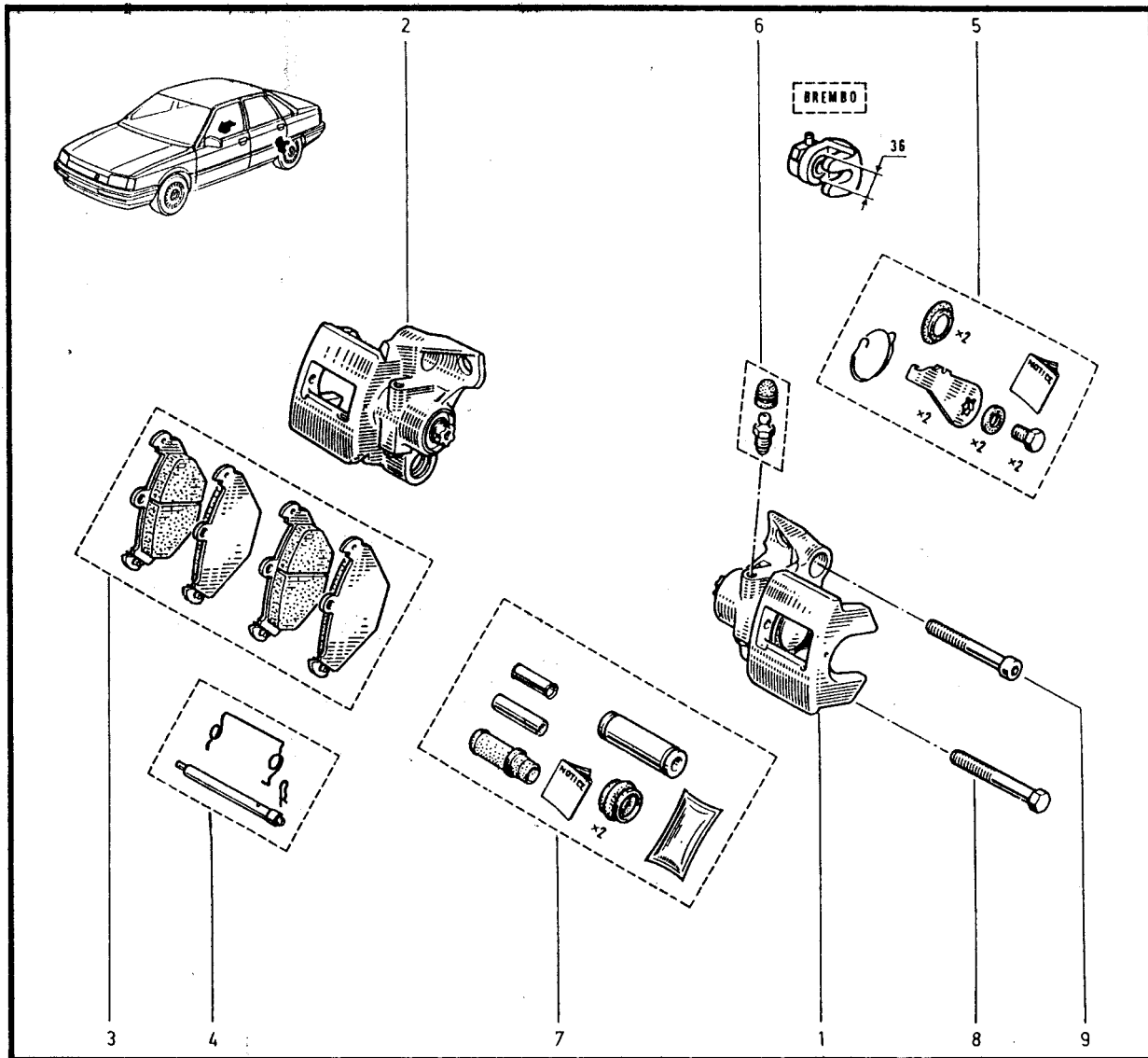



34.40

P.R. 1233

- 1- 77 01 032 318
- 2- 77 01 032 319
- 3- 77 01 348 674
- 77 02 206 166
- 4- 79 03 056 008
- 5- 77 03 001 118

34.40

P.R. 1233

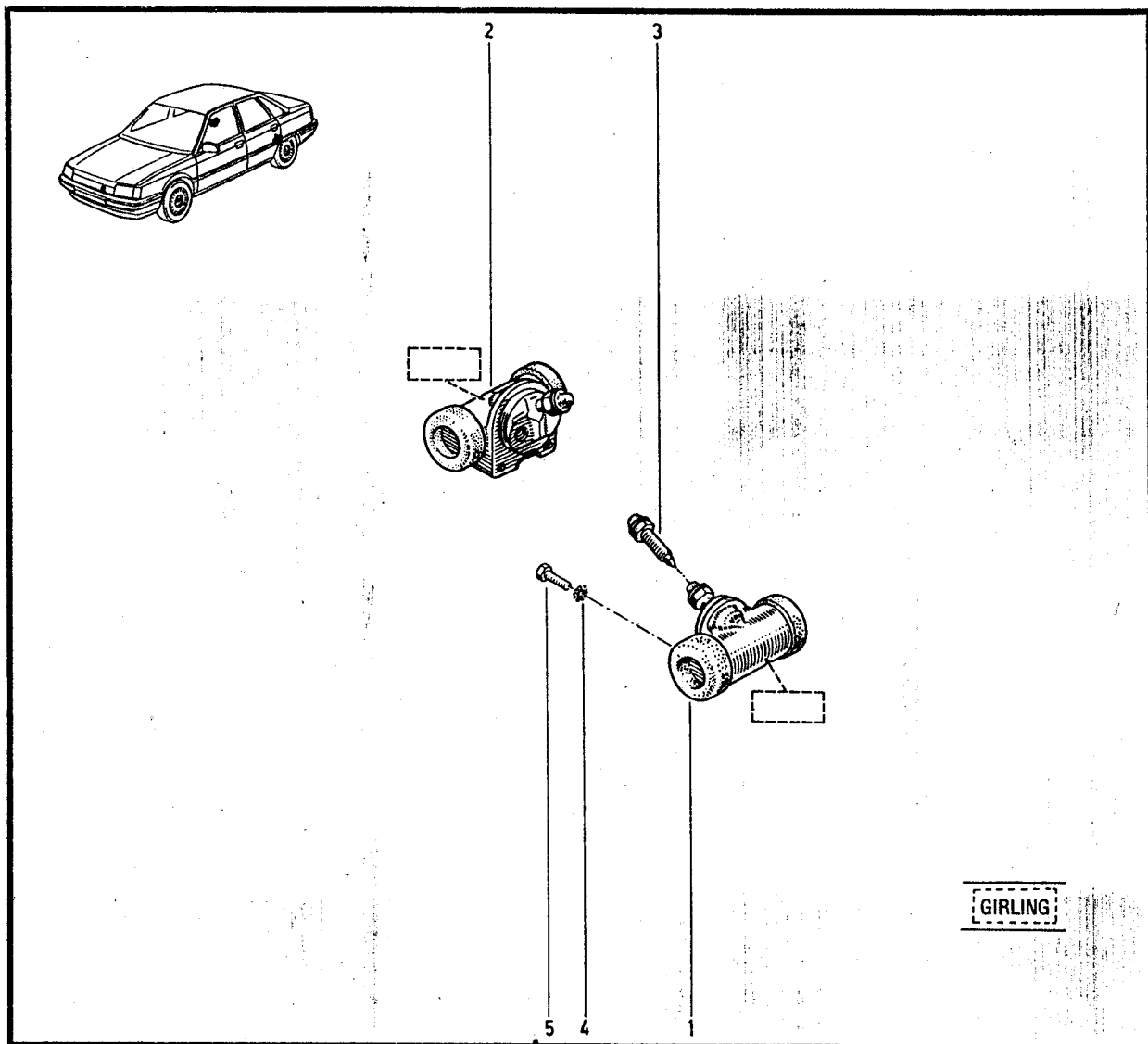



35.05
P.R. 1233

35.05
P.R. 1233



- 1- 77 00 730 930 [≠] (a)
- 77 02 095 390 [≠] (c)
- 2- 77 00 630 267
- 3- 77 00 668 275
- * 4- 77 00 791 348 (c)
- 5- 77 00 791 350 (a)
- 6- 77 02 095 091 (b)
- 77 02 095 995 (b)
- 7- 77 00 730 561 (b)

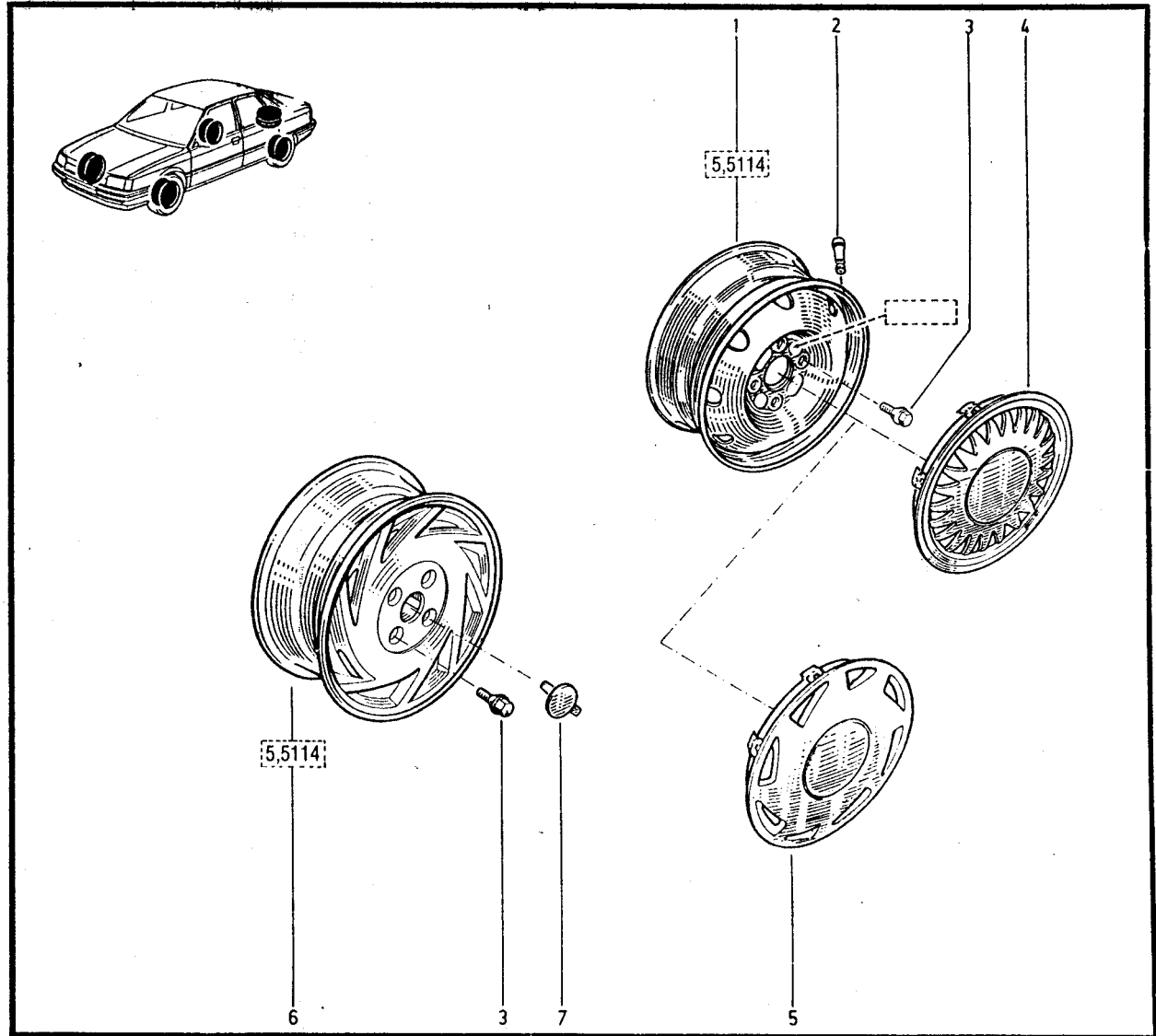

(a) / L488 089 / K488 089
L48G 202 / K48G 202

(c) / K487 089

(b) / K48S 090/091
K48S 090/092
L48X 208/210
K48Y 090/092
L48Y 091/090
L48Z 091/095/096
L48K 209



36.01
P.R. 1233

36.01
P.R. 1233

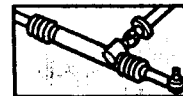

1-77 02 096 396 ⊕
60 00 022 091 ⊕

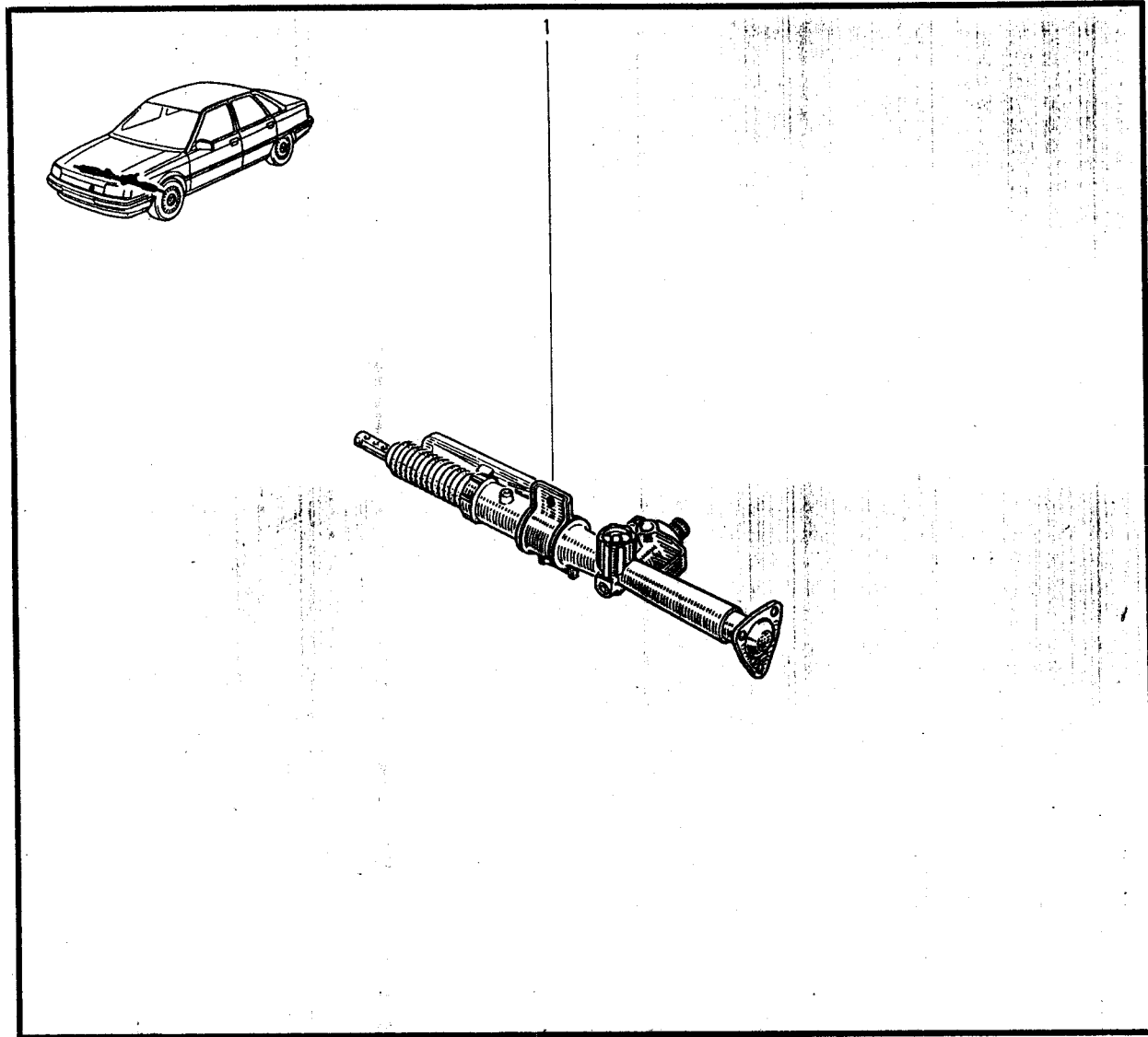



36 10

P.R. 1233

- 1 - 77 00 765 311
- 2 - 77 03 072 046
- 3 - 77 00 760 479
- 4 - 77 00 772 876
- 5 - 77 00 768 122
- 6 - 77 03 053 389
- 7 - 77 03 034 106
- 8 - 77 05 015 212
- 9 - 77 03 065 164
- 10 - 77 00 774 030

36 10

P.R. 1233

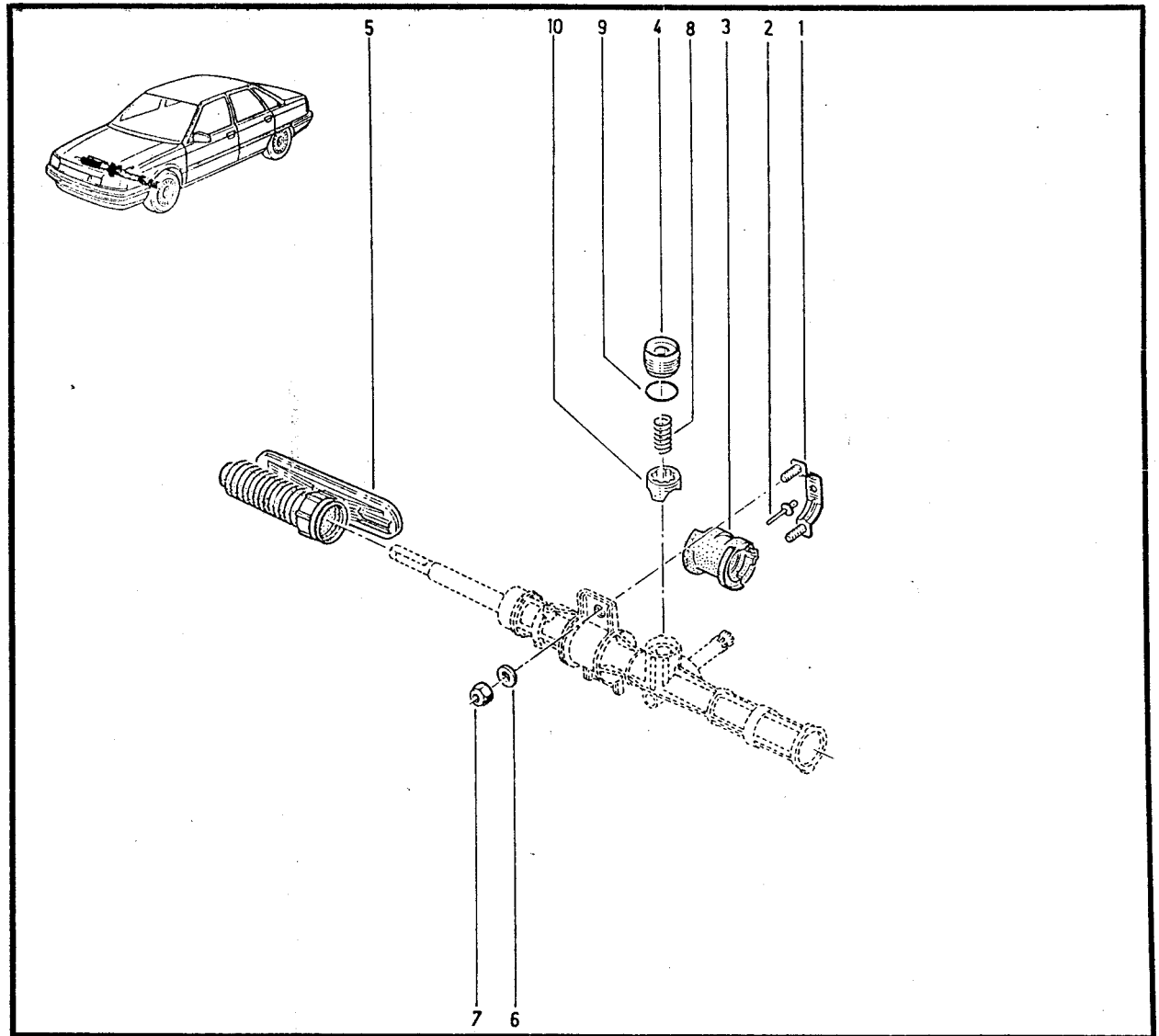
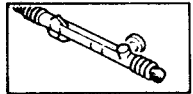



36.30

P.R. 1233

36.30

P.R. 1233



- 1- 77 00 757 111
- 2- 50 03 032 165
- 3- 77 03 090 293
- 4- 77 03 034 027
- 5- 77 03 101 230
- 6- 77 00 765 658
- 7- 77 00 772 828
- 8- 77 03 081 101
- 9- 77 00 770 968
- 10- 77 00 771 274
- 11- 77 03 081 064
- 12- 77 00 761 713
- 13- 77 03 101 074
- 14- 77 03 053 075
- 15- 77 03 034 106
- 16- 77 01 624 286
- 17- 77 01 624 287
- 18- 77 00 761 708
- 19- 77 01 464 441
- 20- 77 00 549 694
- 21- 77 03 034 114
- 22- 50 03 032 140
- 23- 77 00 767 524

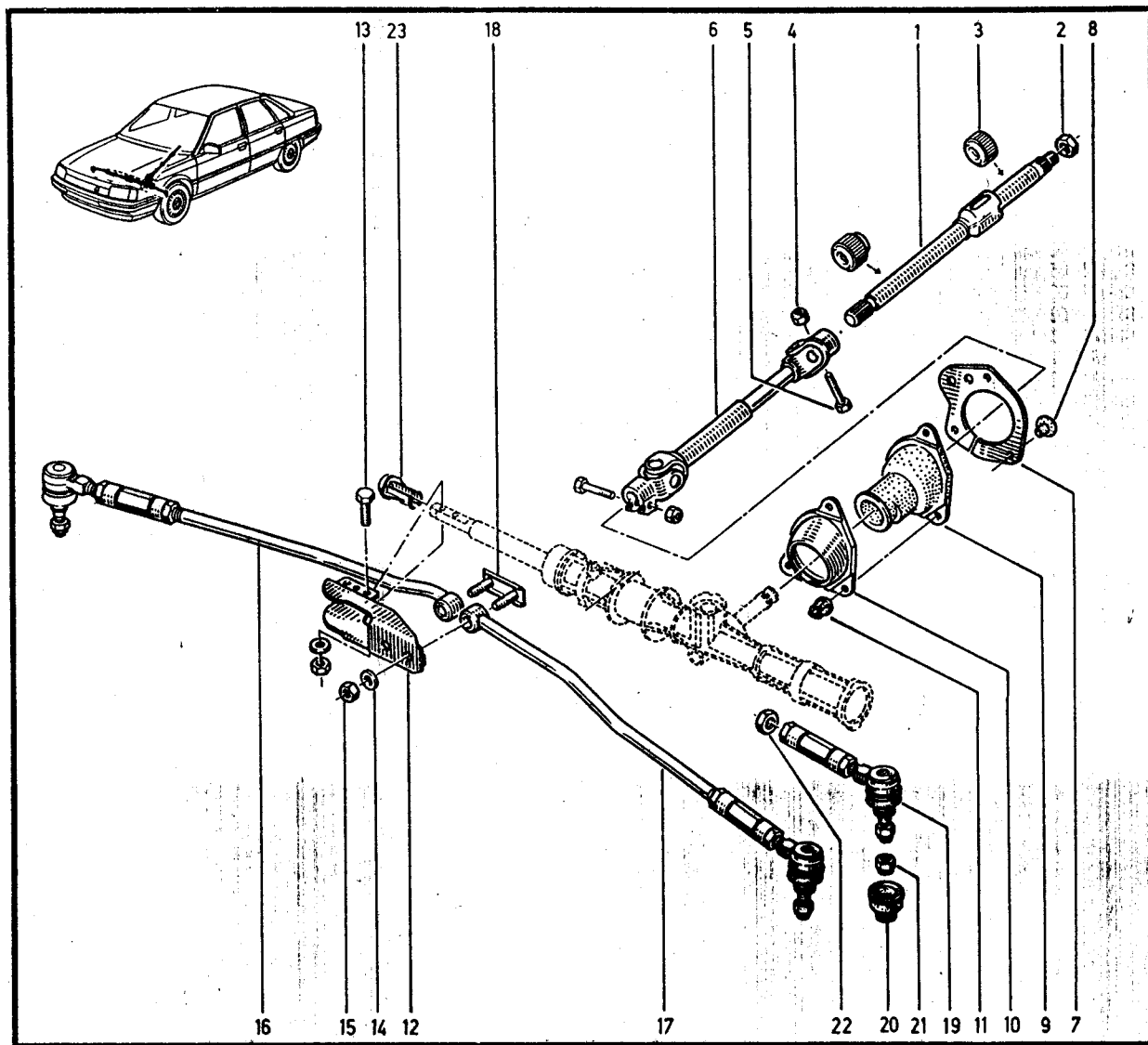

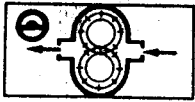

36.32
P.R. 1233

- 1- 77 00 802 364
- 2- 77 00 730 215
- 3- 77 03 101 045
- 4- 77 03 053 043
- 5- 77 00 862 130
- 6- 77 03 101 075
- 7- 79 03 056 046
- 8- 77 03 101 072
- 77 03 001 244
- 9- 79 03 032 018
- 10- 77 00 862 127
- 11- 77 05 098 084
- 12- 77 03 053 036
- 13- 79 03 032 012
- 14- 77 00 730 690†
- 77 02 086 824
- 15- 77 03 001 634
- 16- 77 03 053 037
- 17- 77 03 101 216
- 18- 77 03 058 045
- 19- 77 02 086 620
- 77 02 217 550
- 20- 77 00 730 610
- 21- 79 03 032 018
- 22- 77 03 001 169
- 23- 77 03 053 043

36.32
P.R. 1233

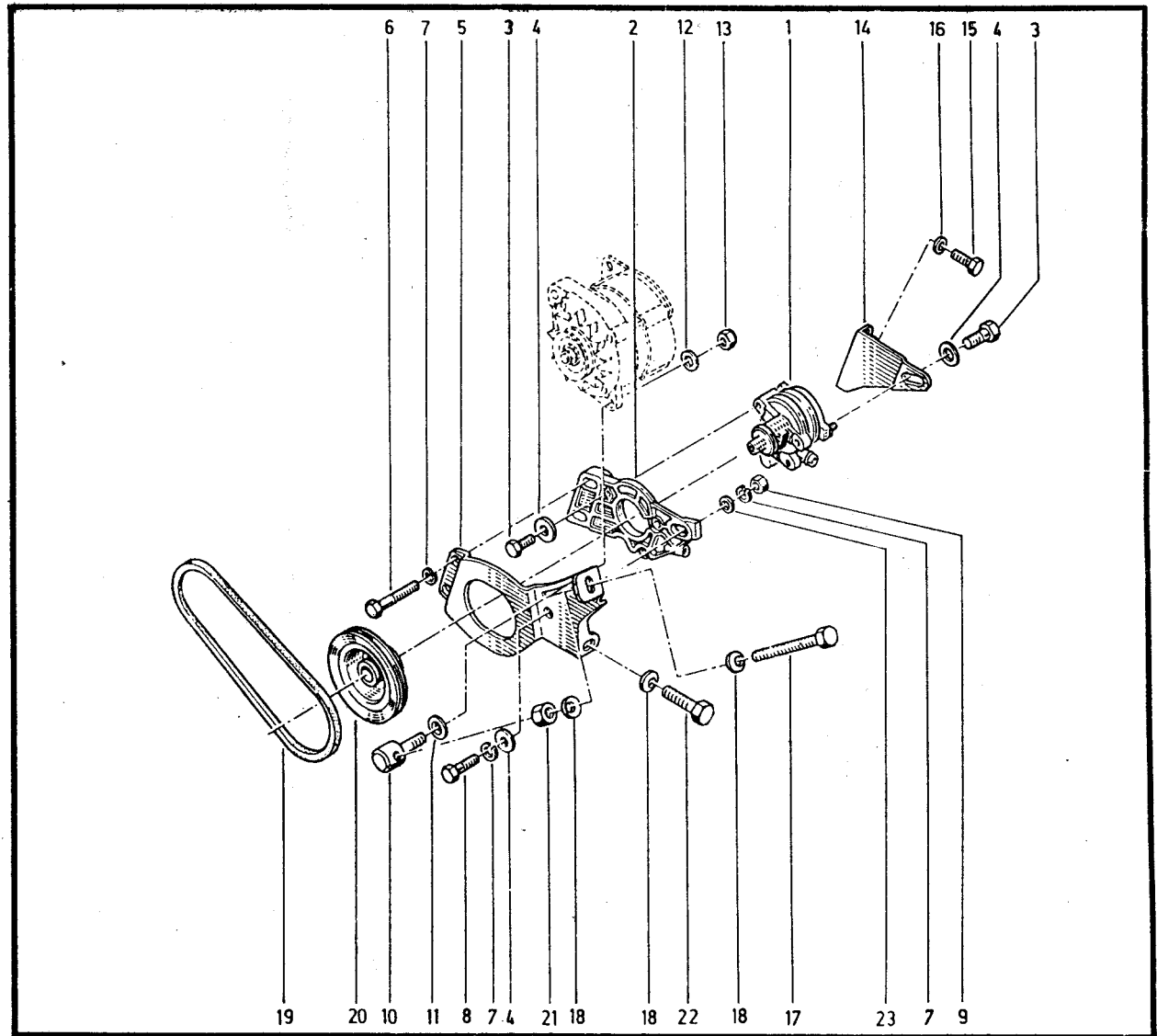
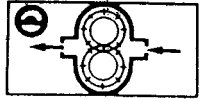



36 .35
P.R. 1233

36 .35
P.R. 1233

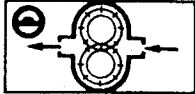

- 1- 77 00 764 523
- 2- 77 00 816 919
- 3- 77 04 001 432
- 4- 77 00 715 482
- 5- 77 03 001 865
- 6- 79 03 056 039
- 7- 77 00 782 757 ✓
- 8- 77 03 065 106
- 9- 77 00 774 525 ✓
- 10- 77 03 065 243
- 11- 77 00 774 531 ✓
- 12- 77 02 094 396
- 13- 77 00 766 927
- 14- 77 03 001 118
- 15- 77 00 768 253
- 16- 77 03 001 447
- 17- 77 00 771 238
- 18- 77 02 094 399
- 19- 77 05 005 119
- 20- 77 02 094 611
- 21- 77 00 788 036
- 22- 77 02 094 586
- 23- 77 03 019 087

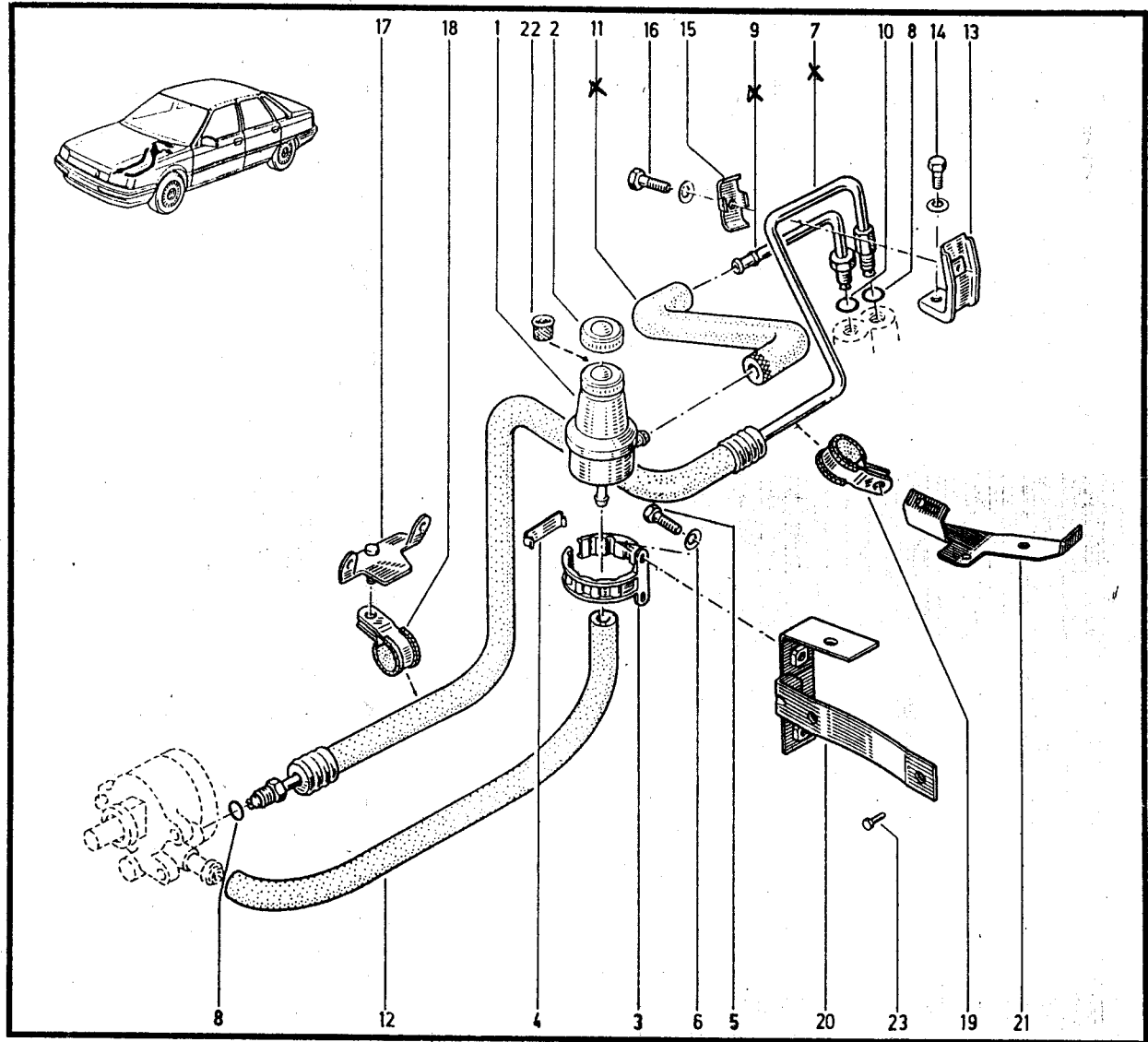

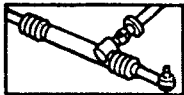

36.37

P.R. 1233

- 1- 77 00 756 964 ✱ (a)
- 2- 77 03 035 018
- 3- 77 03 001 905
- 4- 77 02 094 804 (b)

36.37

P.R. 1233

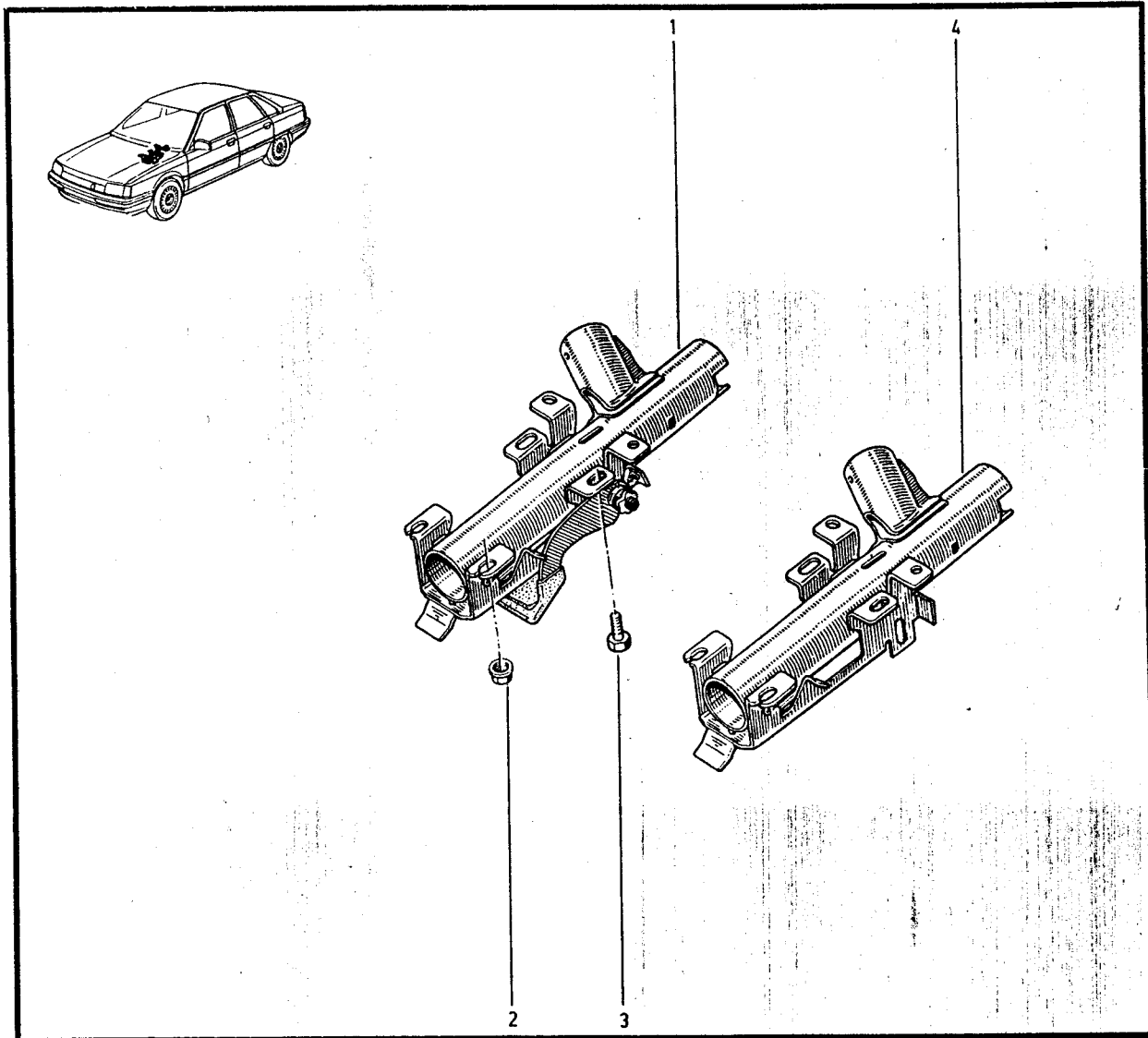

	L48S 090/091
	K48S 090/092
	L48X 208/210
(a)	K48Y 091
	L48Y 091/090
	L48Z 091/095/096
	L48K 209

	K487
	K48G 202
(b)	K488 089
	L488 089
	L48G 202

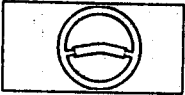

36.40
P.R. 1233

- 1- 77 00 771 792 (a)
- 2- 77 00 772 425 (a)†
- 77 02 095 123 (a)
- 3- 77 00 765 725
- 4- 77 00 790 264 (b)
- 5- 77 02 095 124 (b)
- 77 02 094 654 (b)

36.40
P.R. 1233

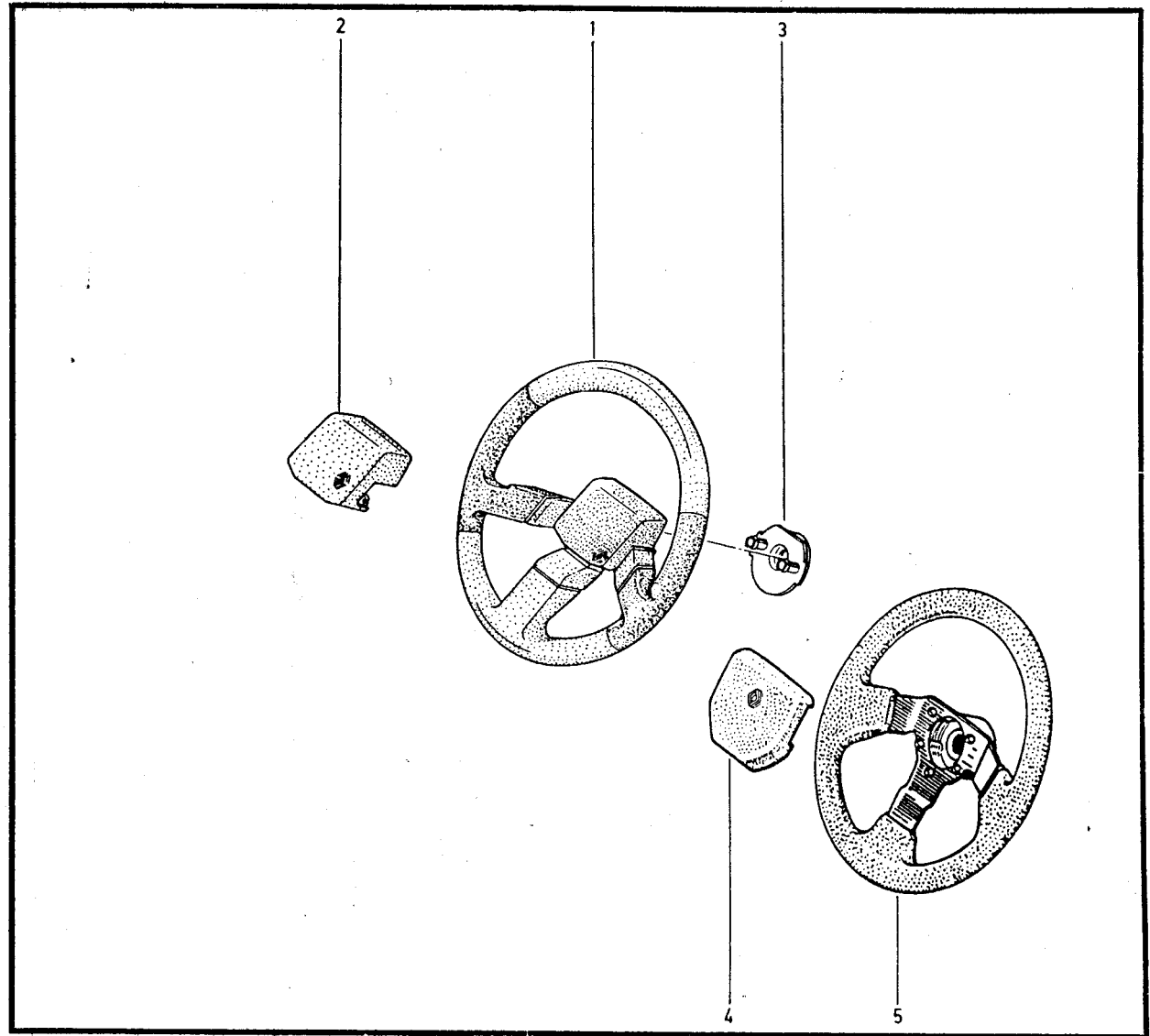
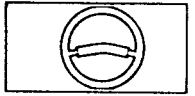

- L488 089 / K488 089
- L48S 091/090
- K48S 090/092 - K487
- (a) L48X 208 / K48X 210
- K48Y 092 / K48Y 090
- L48G 202 / K48G 202
- L48Y 091/090

- (b) / L48Z 091/095/096
- L48K 209

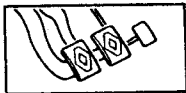

37.01

P.R. 1233

37.01

P.R. 1233

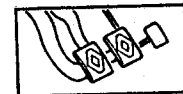

- 1- 77 00 765 394
- 2- 77 00 771 630
- 3- 77 03 035 020
- 4- 77 05 035 153 ††
- 5- 77 03 066 297
- 6- 77 00 765 317 ††
- 77 00 785 790 †† (ABS)
- 7- 77 00 772 857
- 77 03 050 129 (ABS)
- 8- 77 00 680 837 ††
- 9- 77 01 464 301 †
- 77 01 468 034
- 10- 77 03 050 114
- 11- 77 03 068 002
- 12- 77 00 679 618 ††
- 13- 77 03 057 021
- 14- 77 00 779 308 ††
- 15- 77 03 066 241
- 16- 77 00 765 318 ††
- 17- 77 02 094 532 ††
- 18- 77 03 074 379
- 19- 77 00 767 943
- 20- 77 02 094 533
- 21- 77 03 057 061 (ABS)
- 22- 77 02 217 413 (20)
- 77 02 217 549 (21)

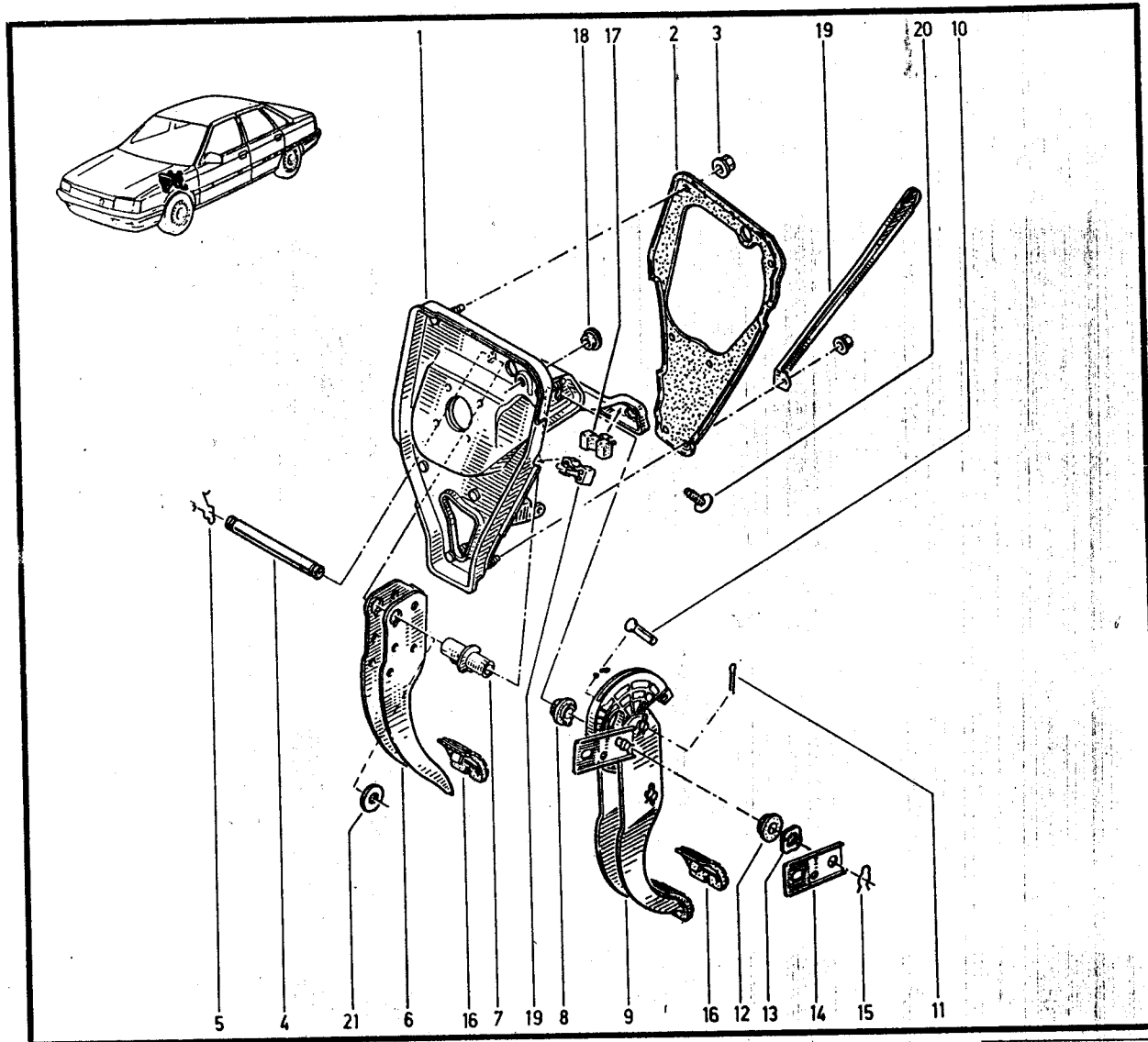

(20) 7701464301
(21) 7701468034

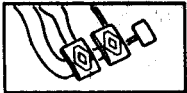

37.20

P.R. 1233

- 1- 77 00 763 191
- 2- 77 00 753 072
- 3- 77 03 001 143
- 4- 79 03 056 042
- 5- 77 03 101 221
- 6- 77 00 757 721
- 7- 77 02 094 165 (a)
- 8- 77 03 079 071
- 9- 77 02 094 534
- 10- 77 02 095 181
- 11- 77 02 095 009 (b)

37.20

P.R. 1233

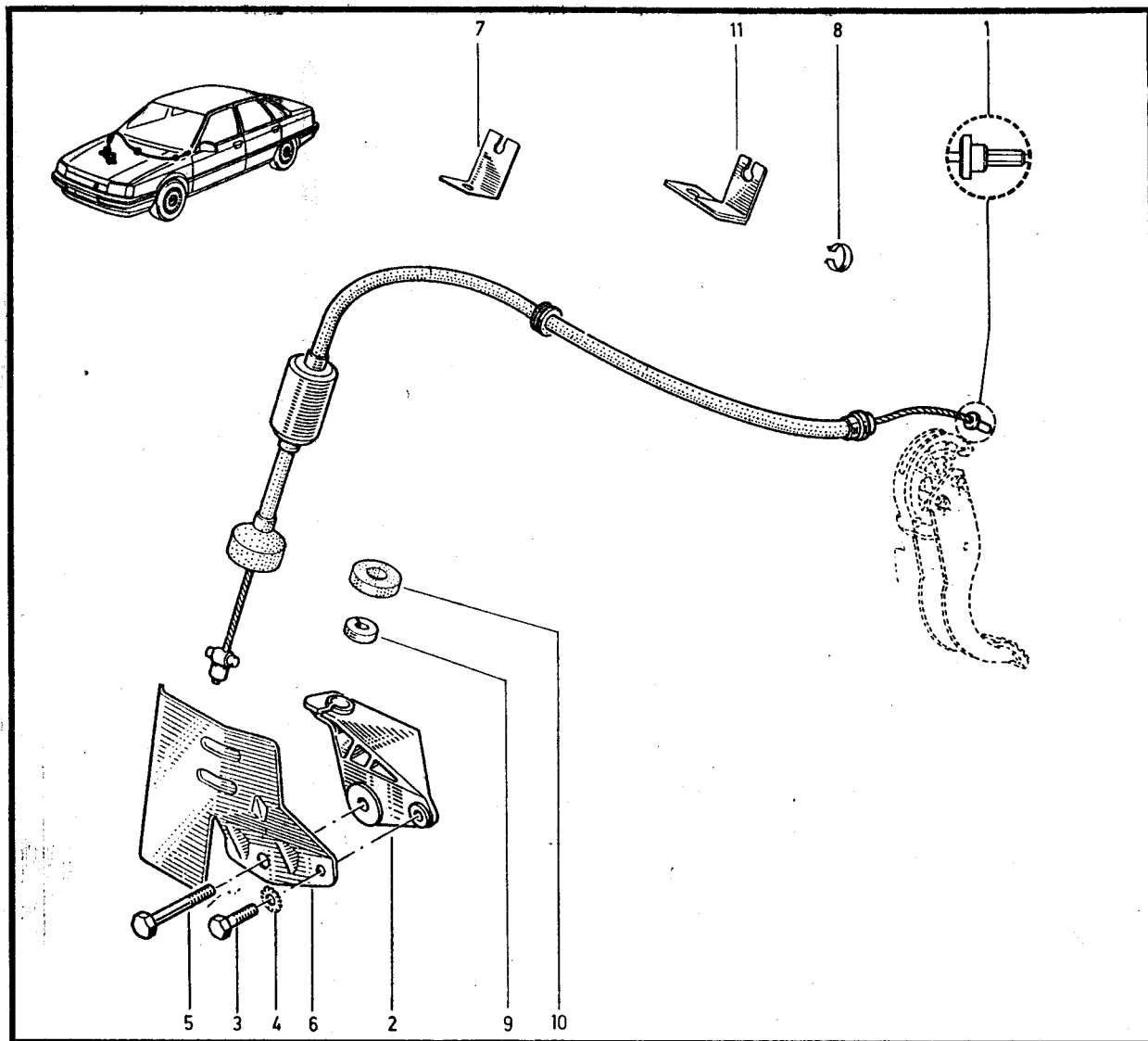
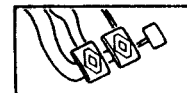

- (a)
- | |
|--------------|
| L48S 090/091 |
| K48S 090/092 |
| L488 089 |
| K488 089 |
| K487 |

- (b)
- | |
|------------------|
| L48Z 091/095/096 |
| K48Y 090/092 |
| L48Y 091/090 |
| K48G 202 |
| L48G 202 |
| L48X 208 |
| K48X 210 |
| L48K 209 |

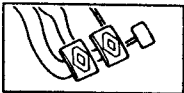

37.30

P.R. 1233

37.30

P.R. 1233

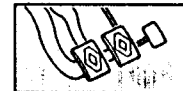

- 1- 77 00 783 430
- 2- 77 00 754 933
- 3- 77 00 768 062
- 4- 77 00 782 087
- 5- 77 03 065 082
- 6- 77 02 094 163 (a)
- 7- 77 03 079 285
- 8- 77 00 768 651
- 9- 79 03 056 054
- 10- 77 03 001 956
- 11- 77 00 783 394 (b)
- 12- 77 05 002 056 (b)
- 13- 77 03 066 295 (b)

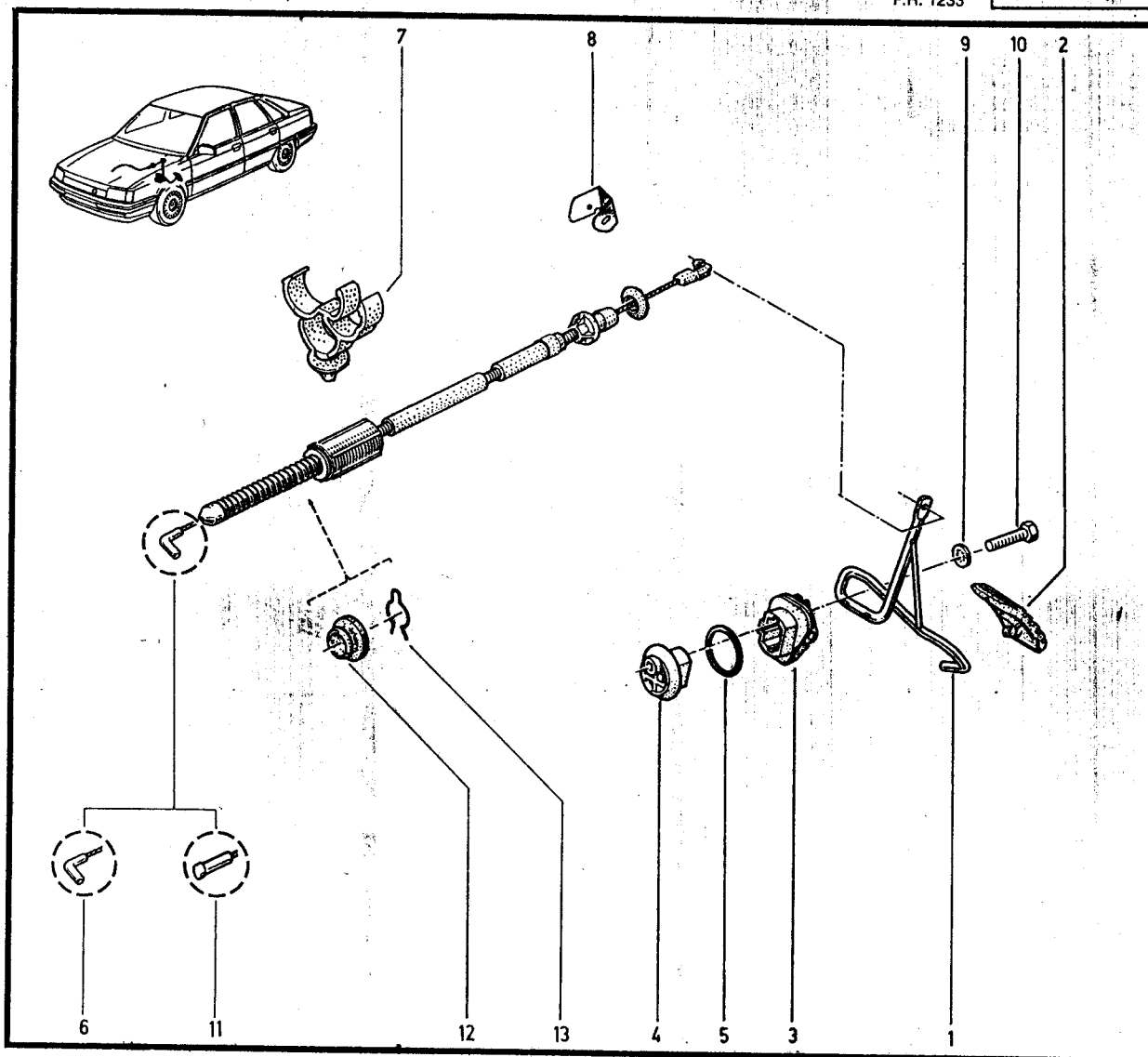

- (a)
- L48S 090/091
 - K48S 090/092
 - L488 089
 - K488 089
 - K487

- (b)
- L48Z 091/095/096
 - K48Y 090/092
 - L48Y 091/090
 - K48G 202
 - L48G 202
 - L48X 208
 - K48X 210
 - L48K 209

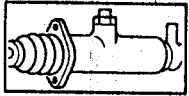

37.40

P.R. 1233

- 1 - 77 00 804 076
- 2 - 77 01 026 873
- 3 - 77 01 021 927
- 4 - 77 01 202 806 (ABS)

37.40

P.R. 1233

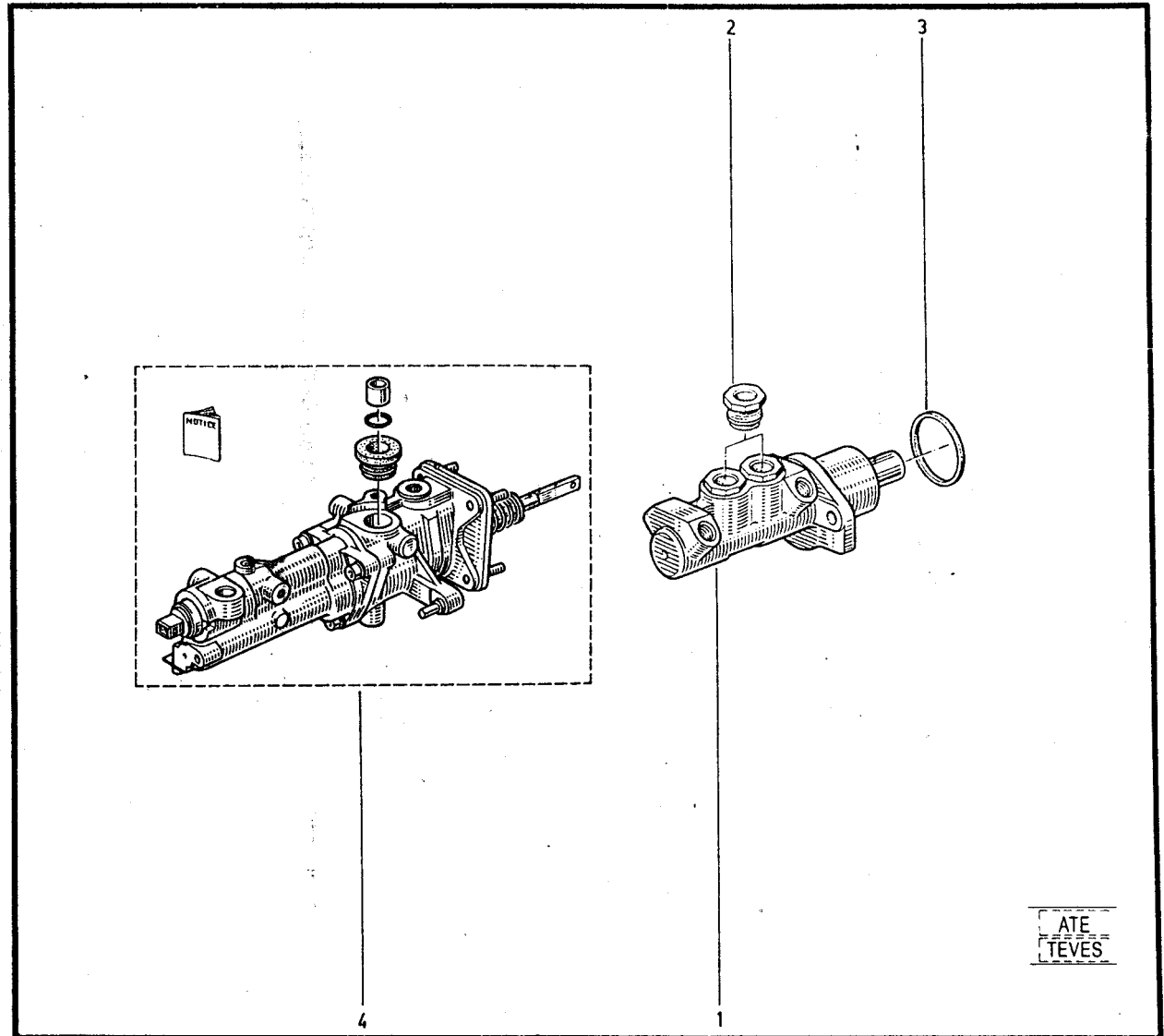
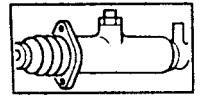

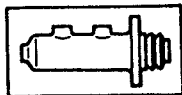

37.50

P.R. 1233

- 1- 77 01 203 193
- 2- 77 00 581 673
- 3- 77 01 202 803 (ABS)
- 4- 77 01 033 354 (ABS)

37.50

P.R. 1233

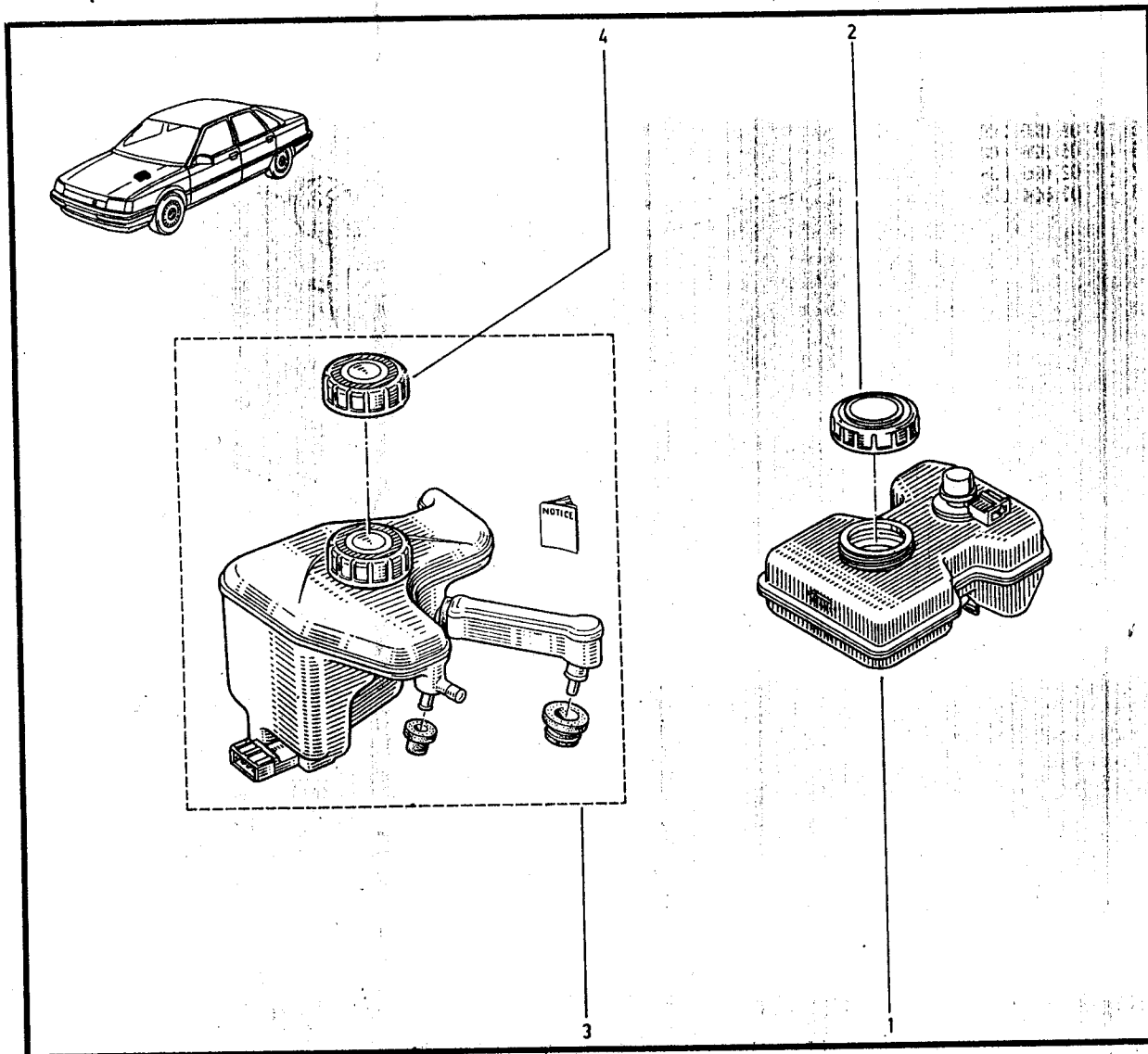
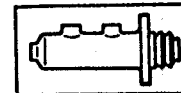



37.60

P.R. 1233

- 1- 77 00 804 074
- 2- 77 01 349 942
- 3- 77 01 202 565
- 4- 77 00 760 337
- 5- 10 89 020 200
- 6- 07 05 328 400
- 7- 77 02 095 038
- 8- 77 00 804 075

37.60

P.R. 1233

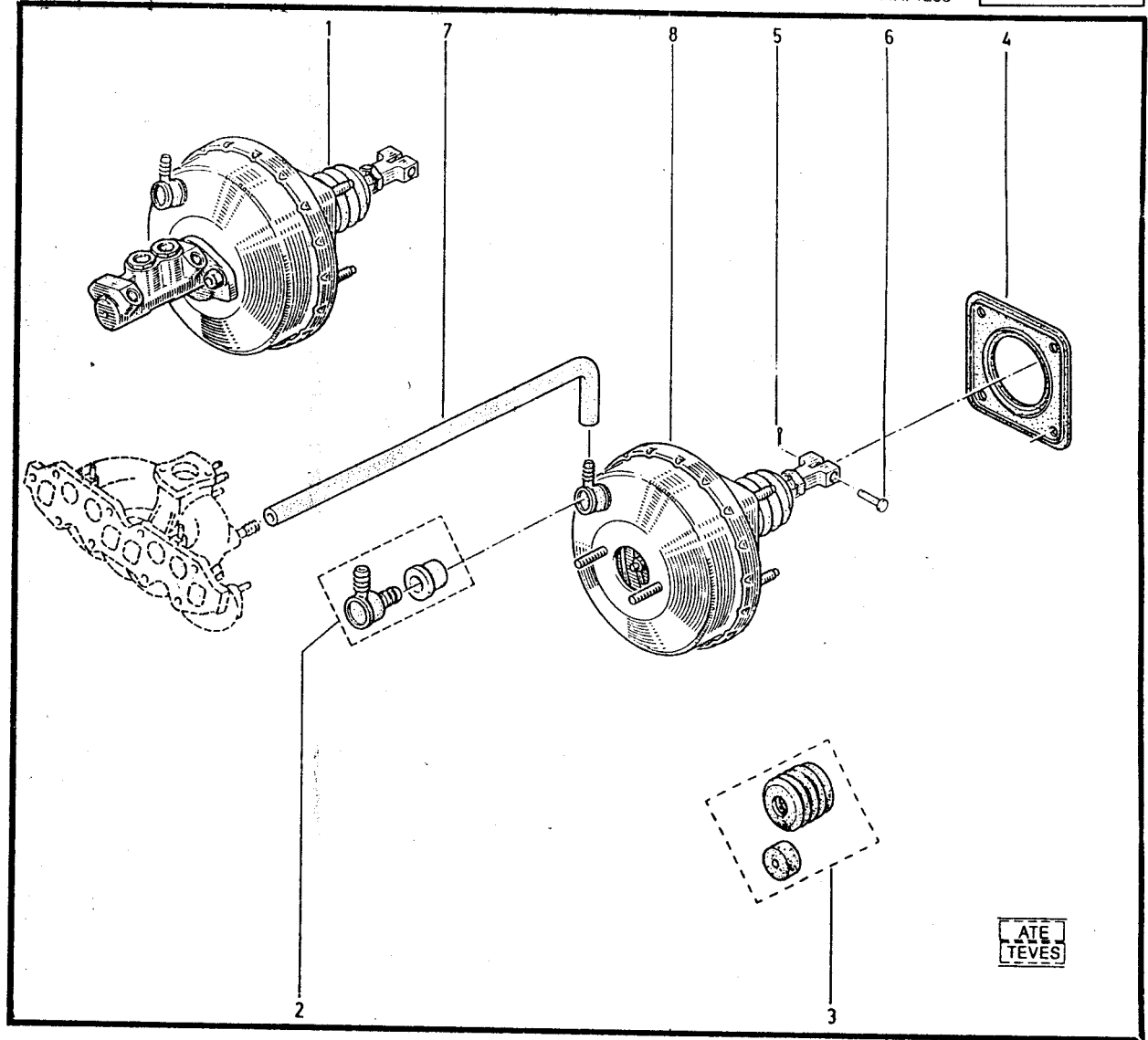
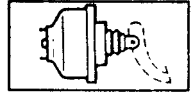

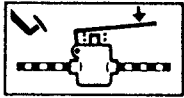

37.70
P.R. 1233

37.70
P.R. 1233

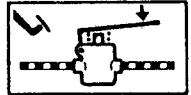

- 1- 77 00 725 424 (a)
- 77 02 094 538 (b)
- 77 00 782 504 (ABS)
- 2- 77 00 639 125
- 3- 77 00 786 166 (ABS)

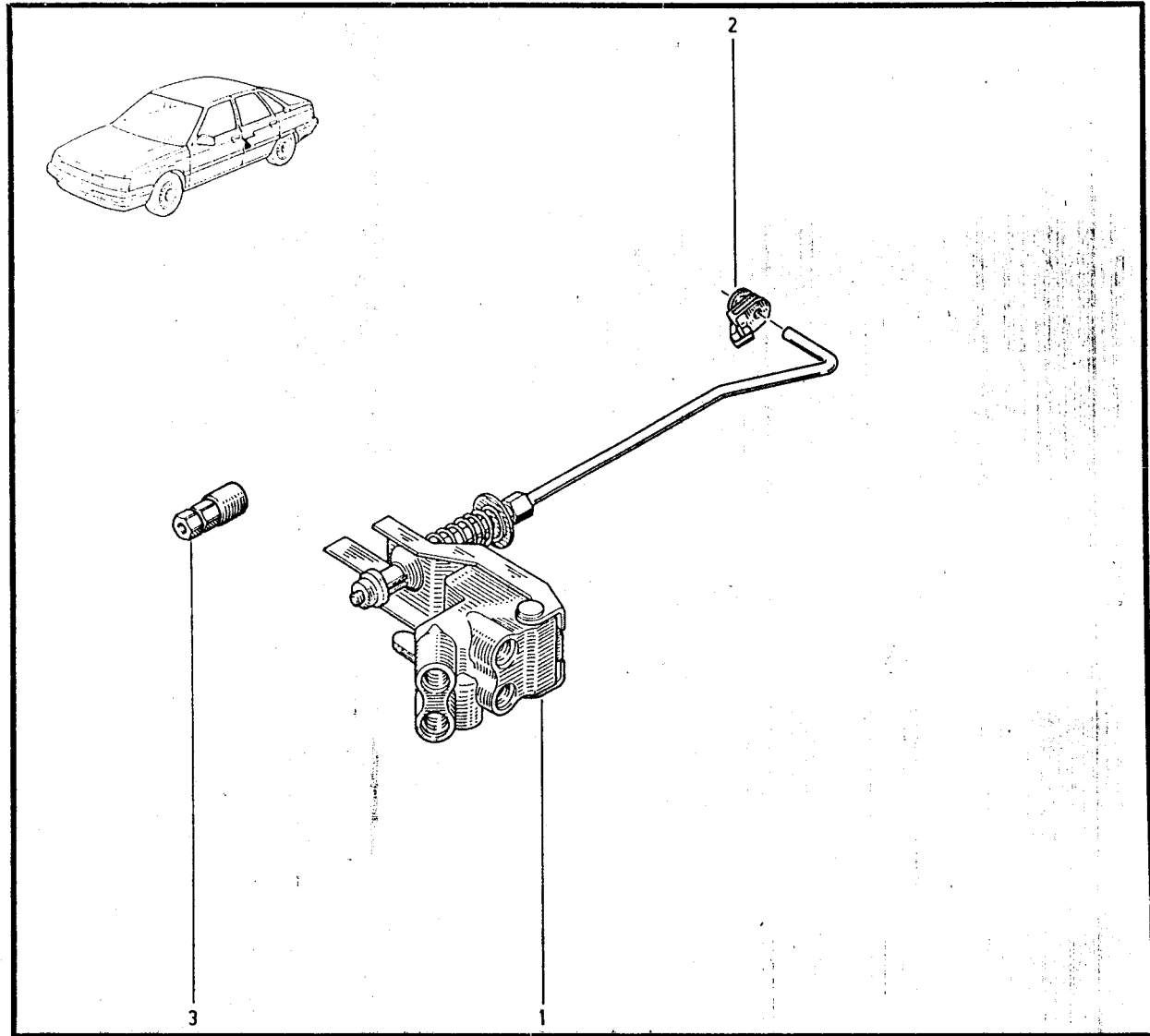

(a) L48S 090/091
L48Z 091
L488 089
L48X 208
L48G 202
L48Y 091/090

(b) K48S 090/092
K48Y 090/092
K48G 202
K48X 210
K488 089- K487

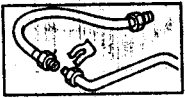

37.80

P.R. 1233

37.80

P.R. 1233

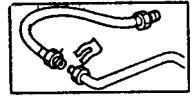

- 1-77 00 768 811
- 2-77 00 768 891
- 3-77 00 768 815 (a)
- 77 00 780 279 (b)
- 4-77 00 768 813 (a)
- 77 00 780 263 (b)
- 5-77 04 001 952
- 6-77 04 001 592
- 7-77 02 094 223 (a)
- 77 02 094 404 (b)
- 8-77 00 771 379
- 9-77 00 743 798
- 10-77 00 769 382 (a)
- 77 00 774 893 (b)
- 11-77 00 769 380 (a)
- 77 00 774 885 (b)
- 12-77 03 079 254
- 13-77 03 079 349
- 14-77 03 079 255
- 15-77 03 079 137
- 16-77 03 079 406
- 17-77 03 079 405
- 18-77 03 079 384
- 19-77 03 079 385
- 20-77 03 079 383
- 21-77 03 079 420 (b)

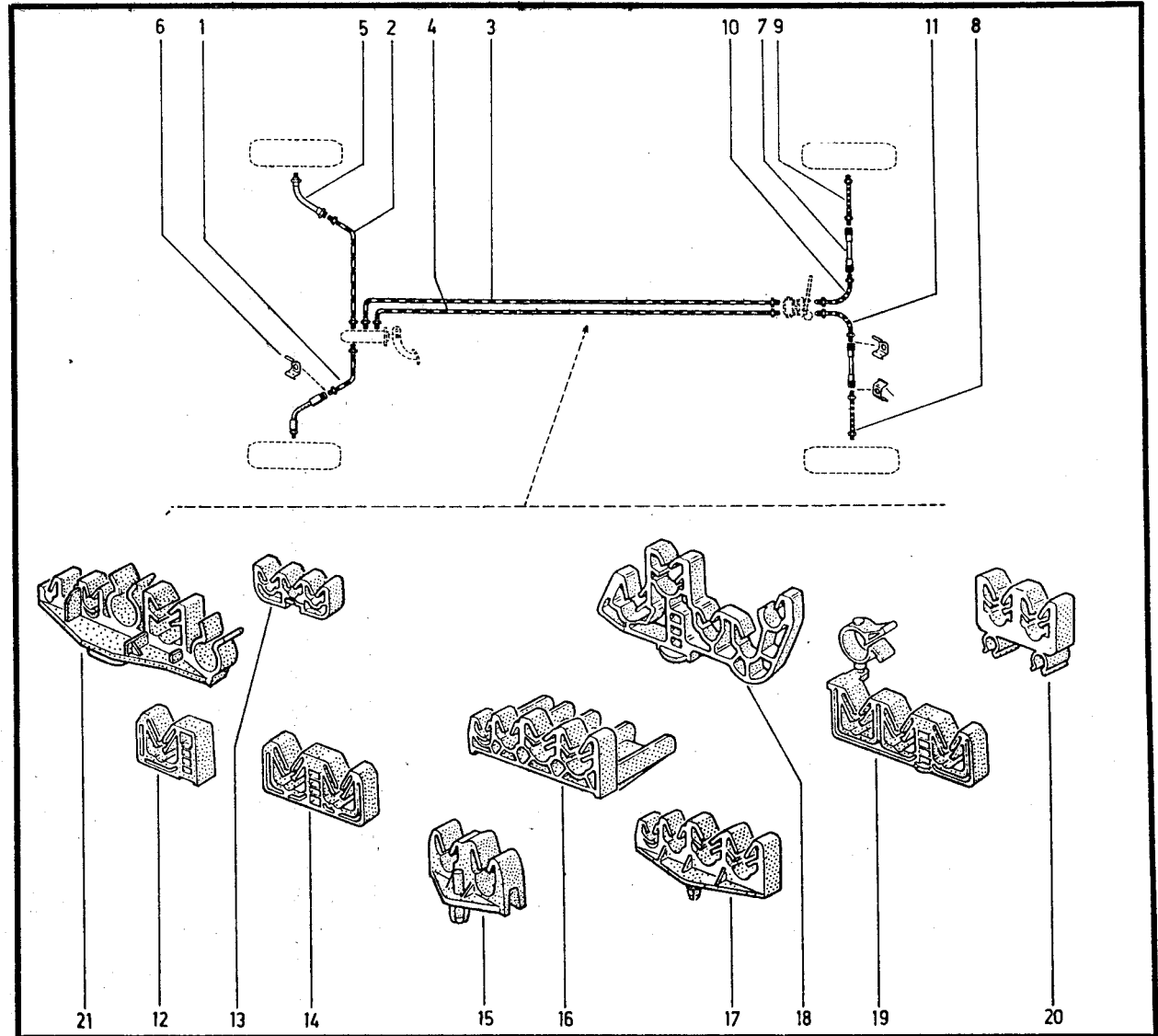

L48S 090/091
L48Z 091
L488 089
L48X 208
L48G 202
L48Y 091/090

K48S 090/092
K48Y 090/092
K488 089-K487
K48X 210
K48G 202

(a)

(b)

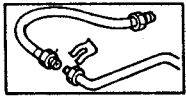

37.81

P.R. 1233

- 1-77 04 001 952
- 2-77 00 778 443
- 3-77 00 778 334
- 4-77 00 786 740
- 5-77 02 095 213
- 6-77 02 094 223
- 7-77 00 790 319
- 8-77 02 095 215
- 9-77 02 095 211
- 10-77 00 769 382
- 11-77 00 778 332
- 12-77 00 814 312

ABS

37.81

P.R. 1233

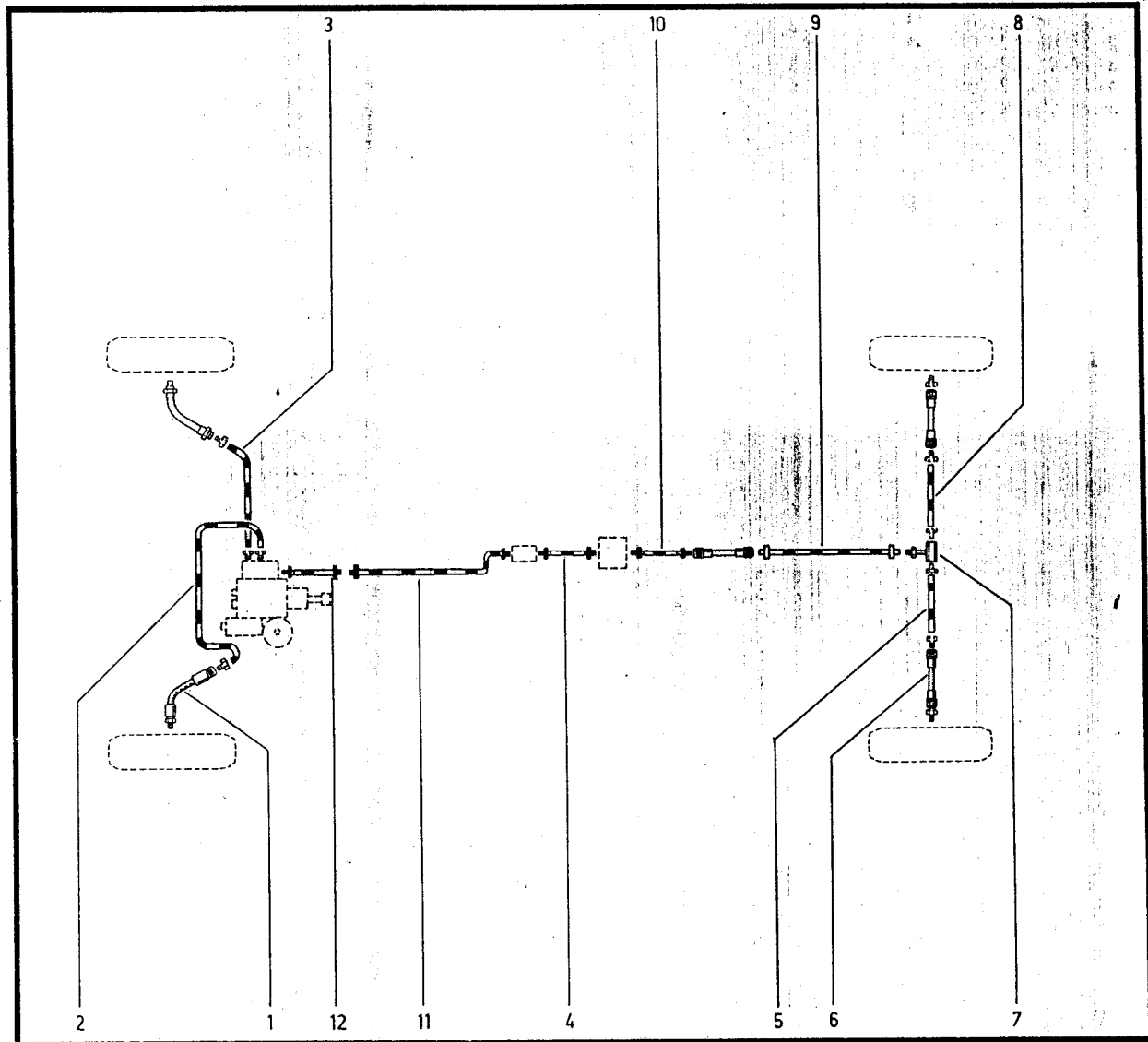
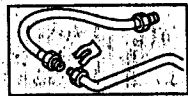

ABS37.92
P.R. 1233

1-77 01 202 800
2-77 01 202 801
3-77 01 202 802
4-77 01 202 805
5-77 01 202 808

(ABS)

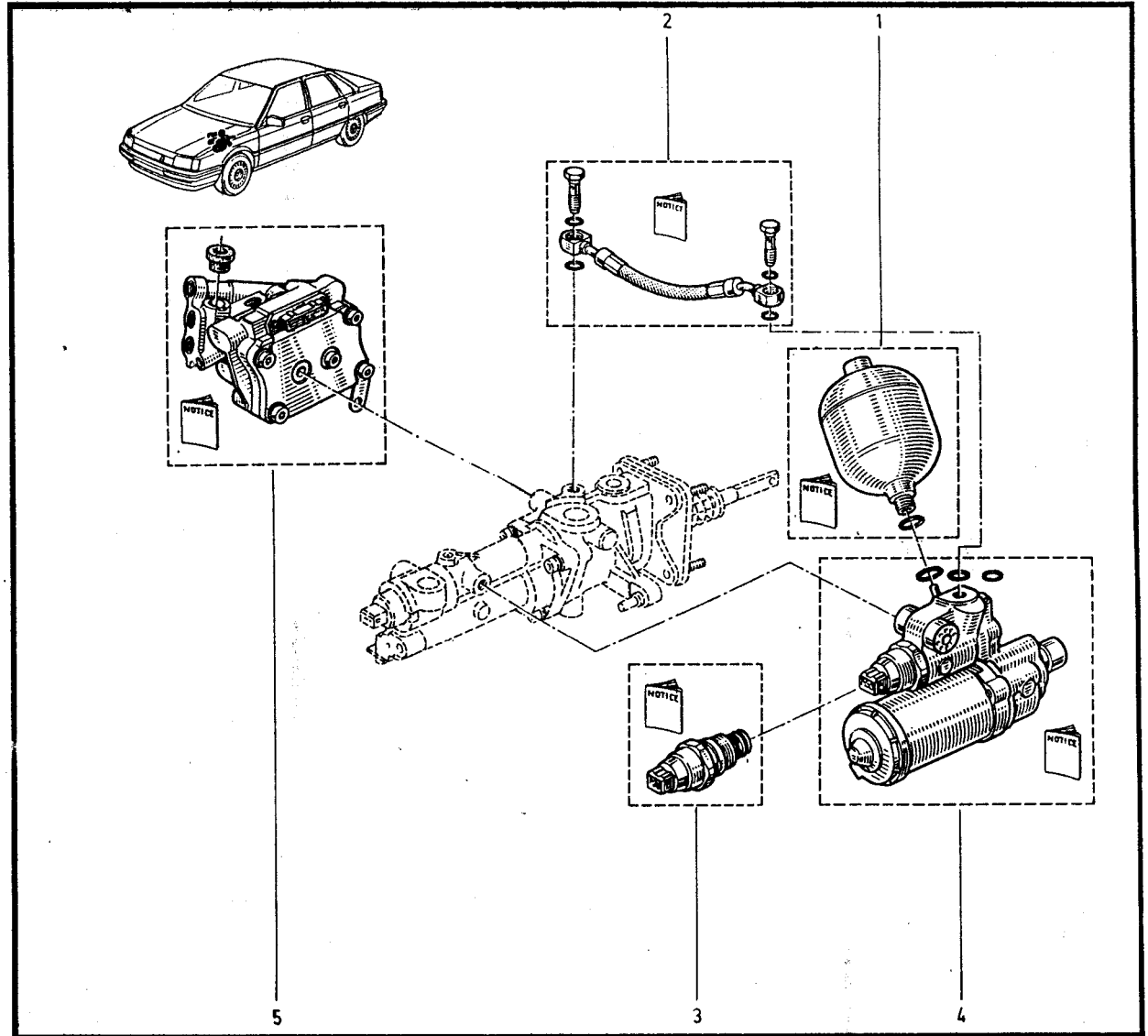
37.92
P.R. 1233**ABS**

ABS37.92.1

P.R. 1233

1- 77 01 202 807
2- 77 01 202 809
3- 77 01 202 804
4- 77 01 202 810

(ABS)

37.92.1

P.R. 1233

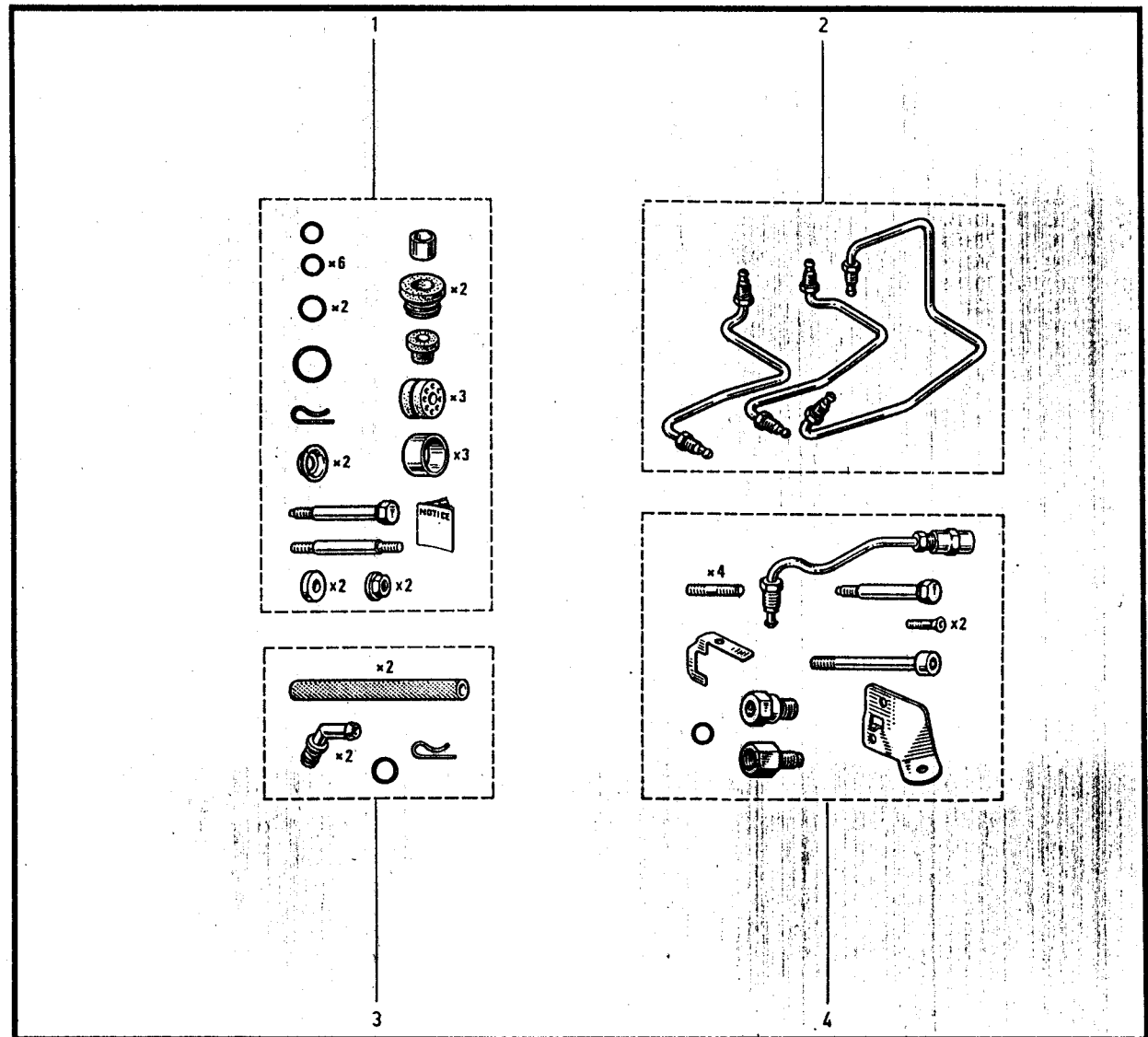
ABS

ABS37.94

P.R. 1233

- 1-77 02 205 426
- 2-77 00 785 075
- 3-77 00 792 425
- 4-77 02 220 176 [22]
- 5-77 00 773 916
- 6-77 00 780 859
- 7-77 00 773 917
- 8-77 00 807 090
- 9-77 00 782 705 [12]
- 10-77 00 787 307 [13]
- 11-77 00 782 706 [5]
- 77 02 218 566 [5]
- 12-77 00 782 704 [5]
- 13-77 03 081 054
- 14-77 00 784 964
- 15-77 00 785 231
- 16-77 00 807 091

(ABS)

37.94

P.R. 1233

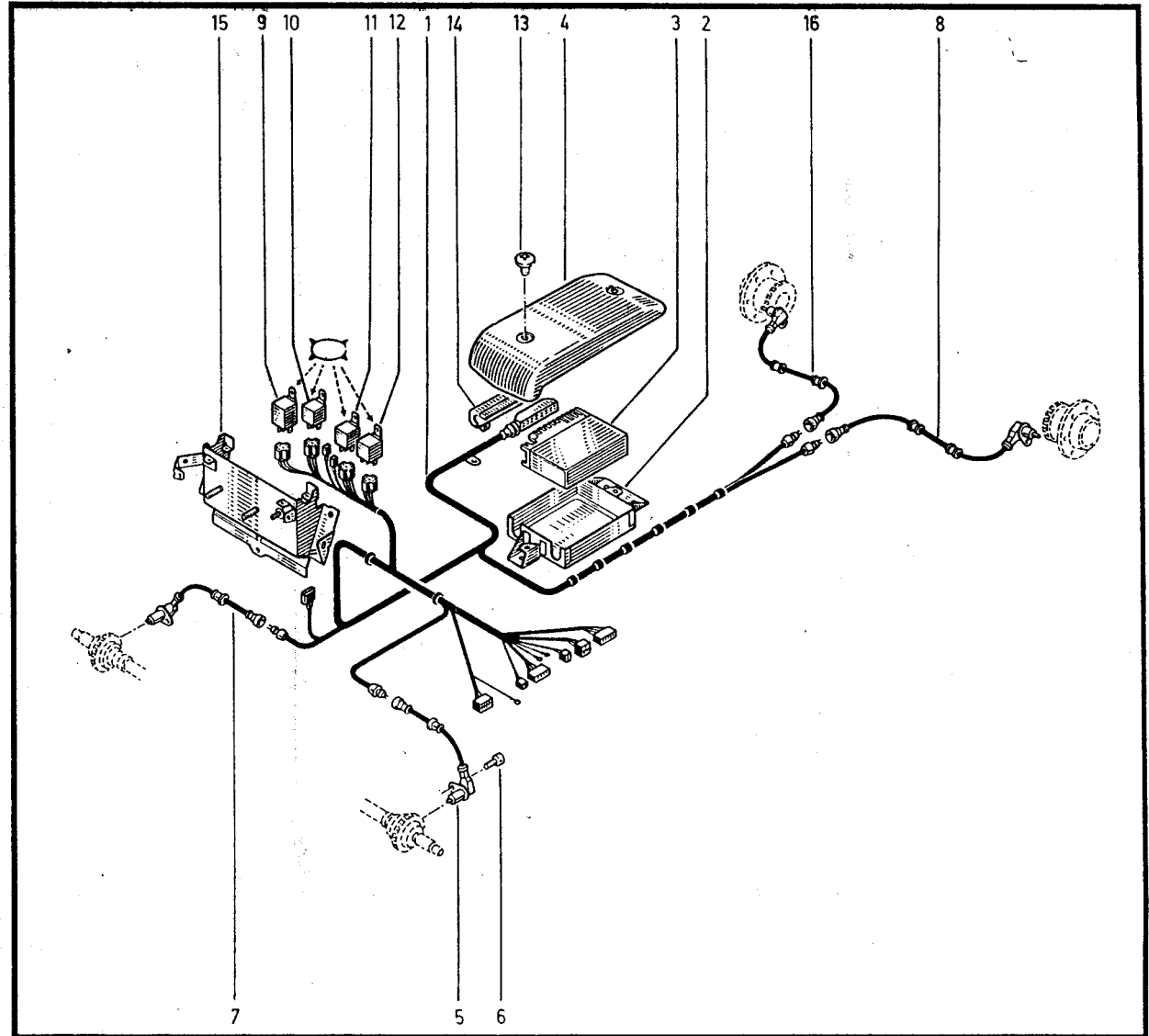
ABS

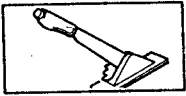

38.01

P.R. 1233

38.01

P.R. 1233



- 1- 77 00 789 846
- 2- 77 00 766 397
- 3- 77 01 366 156
- 4- 77 00 774 237
- 5- 77 00 768 710
- 6- 77 00 800 112
- 7- 77 00 533 137
- 8- 77 00 539 049
- 77 03 034 121
- 9- 77 03 050 054
- 10- 79 03 053 028
- 11- 10 89 020 302
- 12- 06 07 110 900
- 13- 08 24 376 400
- 14- 77 00 769 840 (x=1495)(a)
- 77 00 769 842 (b)
- 77 00 777 520 (x=1576)(c)(ABS)

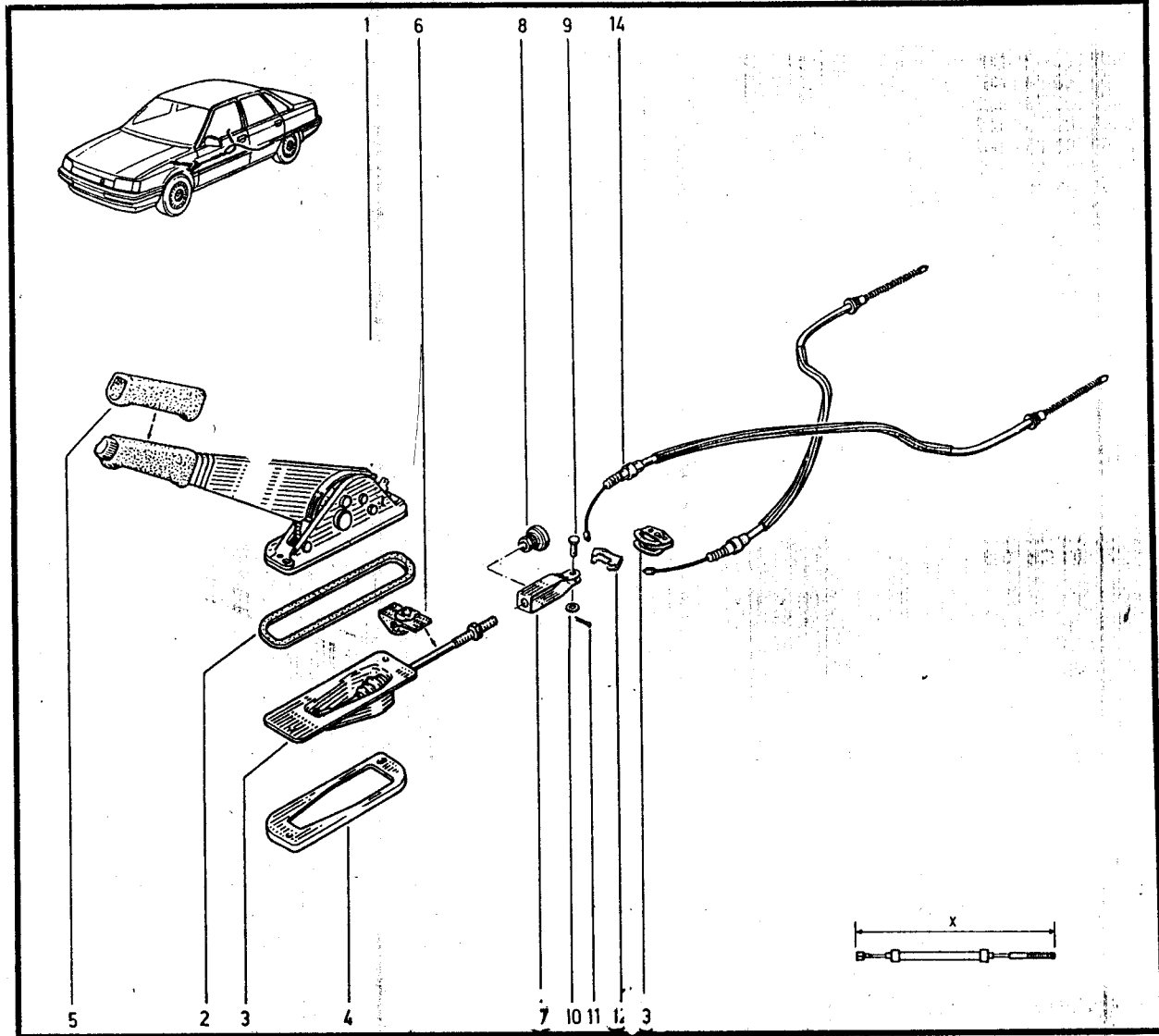

(a)	L48S 090/091
	L48Z 091/095/096
	L488 089
	L48X 208
	L48G 202
	L48Y 091/090

(b)	K48S 090/092
	K48Y 090/092
	K48G 202 - K487
	K48X 210
	K488 089

(c)	L48Z 095
	L48K 209



38.20

P.R. 1233



38.20

P.R. 1233



- 1-77 00 721 901 (x=137,5)
- 2-77 00 721 905
- 3-77 00 740 467
- 4-77 00 738 023
- 5-77 00 733 023
- 6-77 03 055 007
- 7-77 03 001 127
- 8-77 00 717 294
- 9-77 00 729 729
- 10-77 00 689 713
- 11-77 00 692 252
- 12-77 00 720 977
- 13-77 00 721 903
- 14-77 00 726 686
- 15-77 03 074 280
- 16-77 00 788 664 (a)
- 77 00 788 663 (b)
- 17-77 05 015 159
- 18-77 00 715 602
- 19-77 03 067 216
- 20-77 03 034 027
- 21-77 03 053 537
- 22-77 03 053 544
- 23-77 03 035 018
- 77 03 035 003

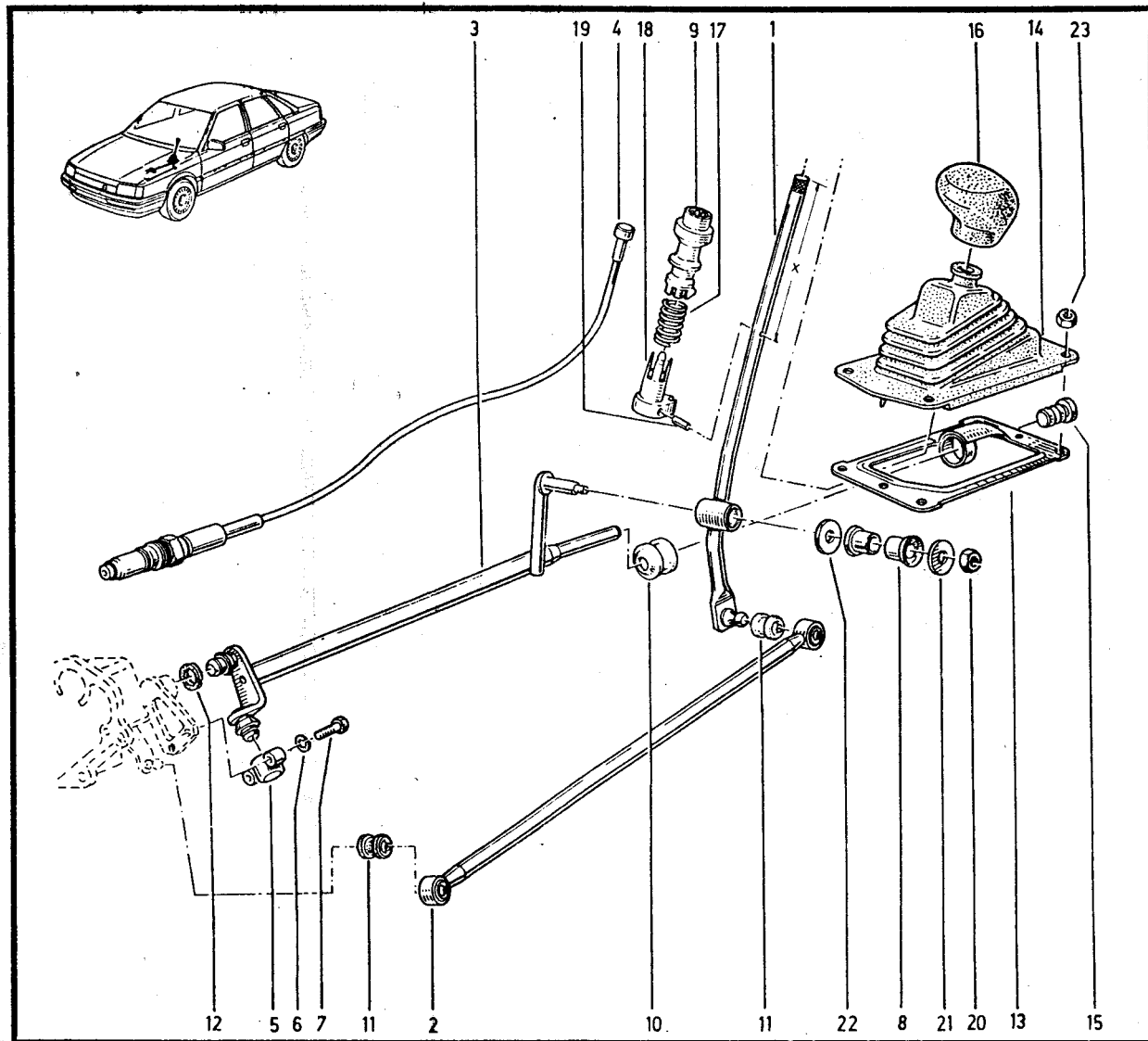

L48S 090/091
L48Y 091/090
L48Z 091/095
L48X 208
L48K 209
K48S 090/092
K48Y 090/092
K48X 210

(a)	K487
(b)	L48G 202
	K48G 202
	L488 089
	K488 089

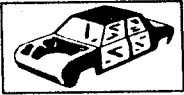

40.01

P.R. 1233

- 1- 77 02 206 805 (a)
- 2- 77 02 217 326 (b)
- 77 02 206 806 (c)

40.01

P.R. 1233

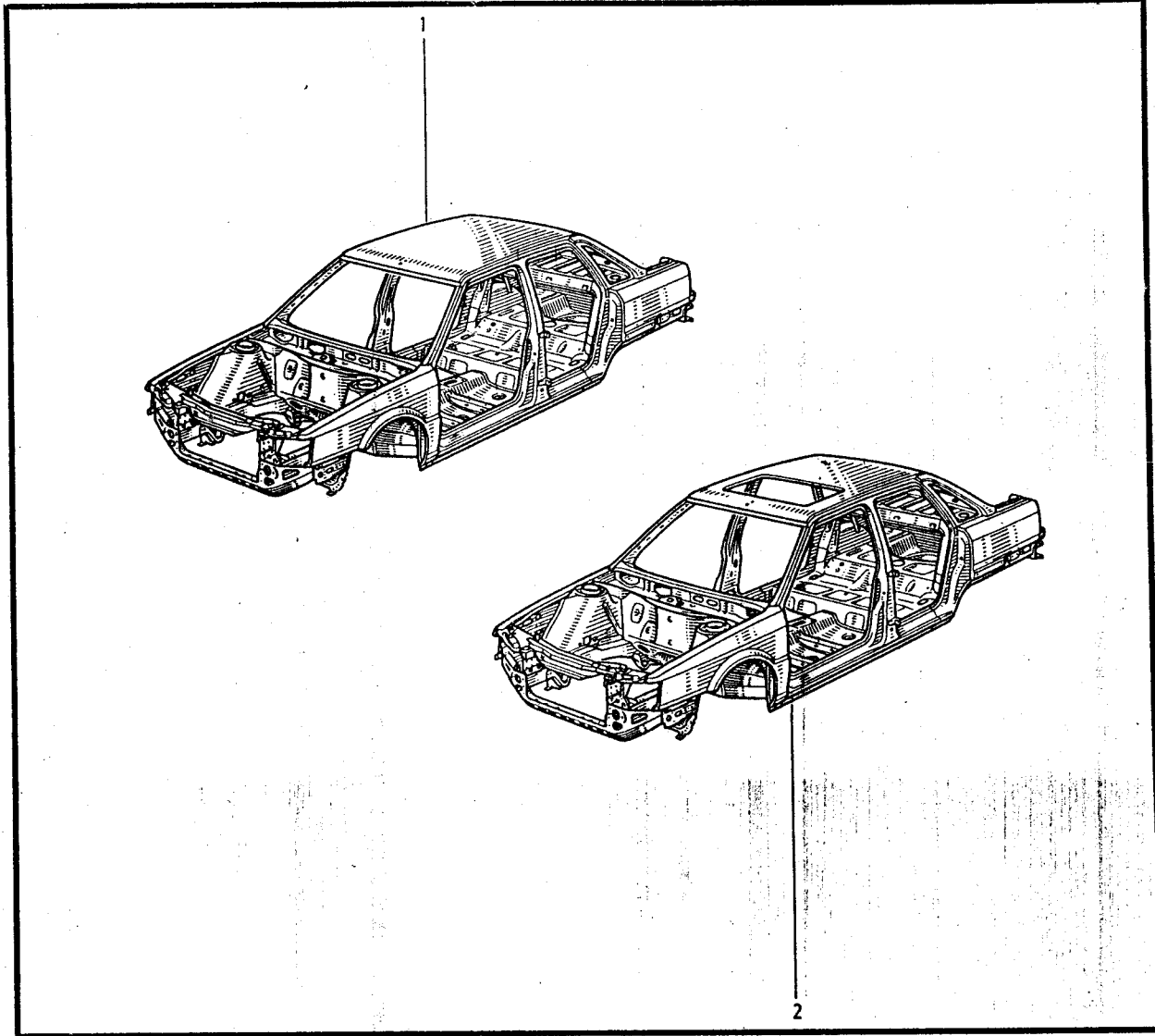

2

(a)	L48Y 090
	L488 089
	L48G 202
	L48S 090
(b)	L48S 091

(c)	L48X 208
	L48Z 091
	L48Z 095
	L48Y 091
	L48K 209

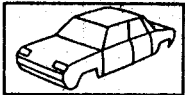

40.01.1

P.R. 1233

1 - 77 02 206 216 (a)
77 02 206 818 (b)

40.01.1

P.R. 1233

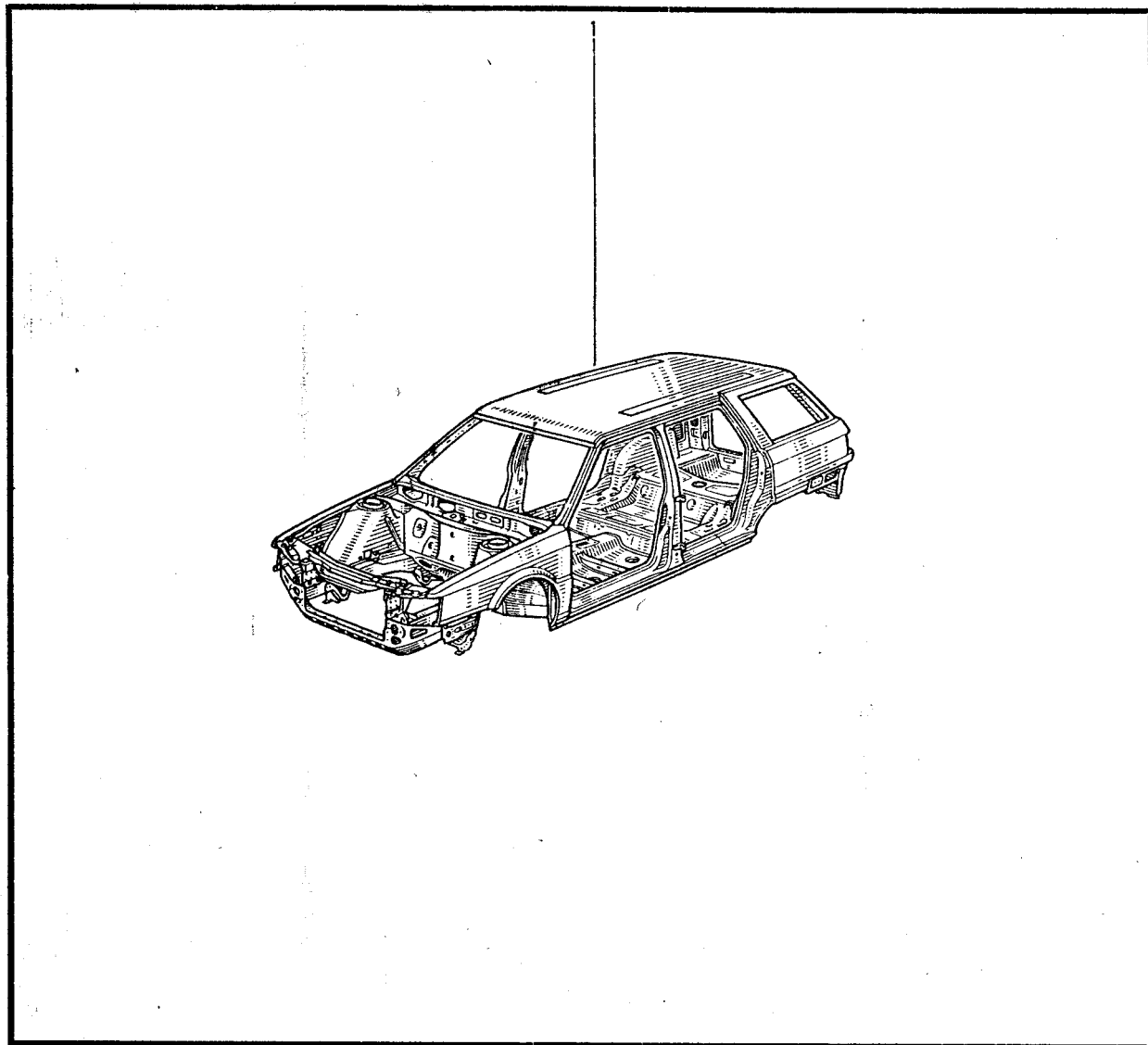
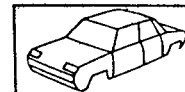

	K487
	K488 089/202
(a)	K48Y 090
	K48S 090
	K48S 092
(b)	K48Y 092
	K48X 210

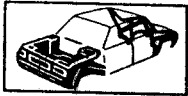

40.10

P.R. 1233

- 1- 77 02 206 181
- 2- 77 51 626 933
- 3- 77 01 463 698
- 4- 77 02 206 182†
- 77 02 217 509
- 5- 77 51 626 932

40.10

P.R. 1233

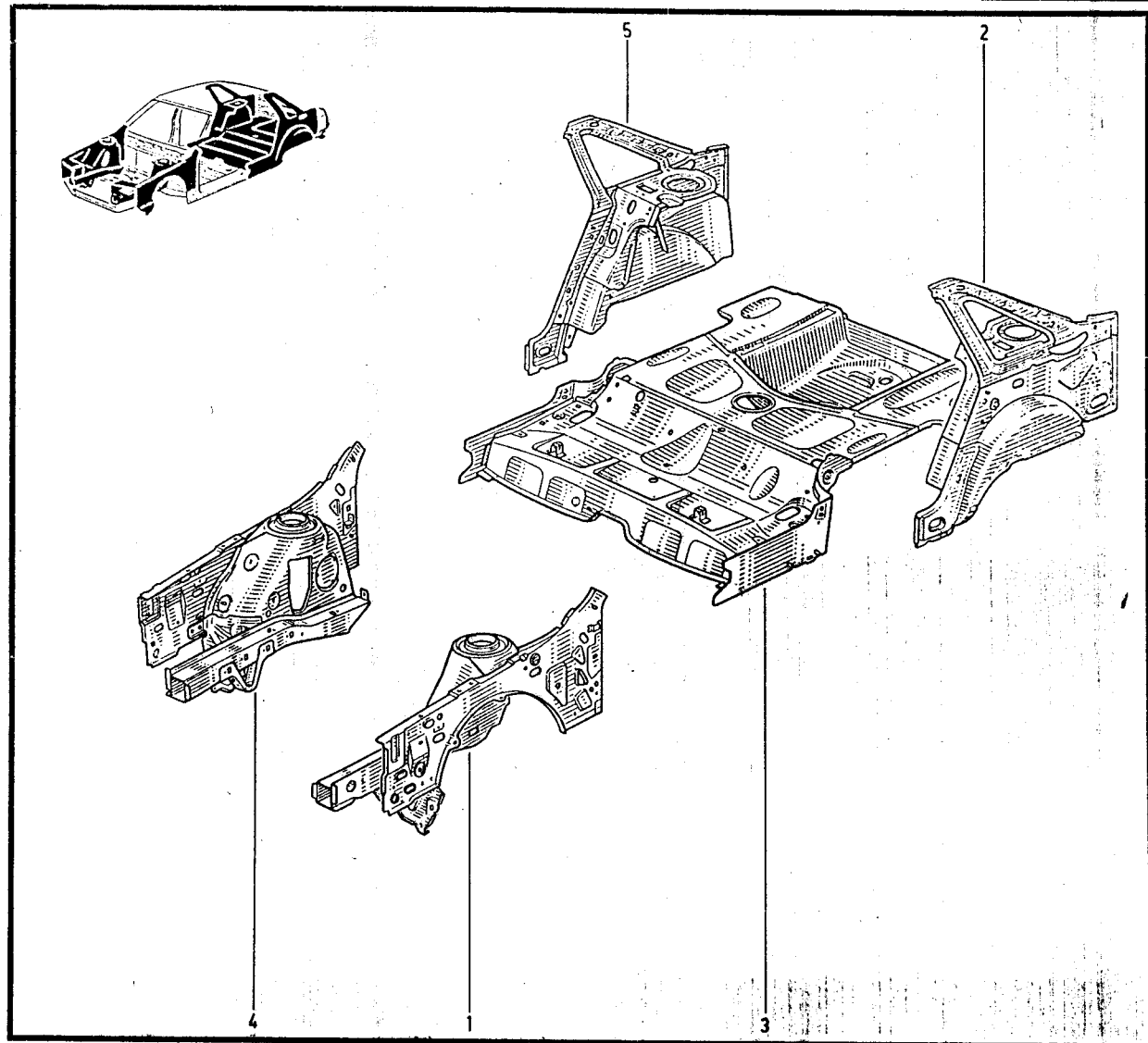



40.10.1

12.94 P.R. 1233

- 1- 77 02 206 181
- 2- 77 51 465 607
- 3- 77 51 629 112
- 4- 77 02 206 182†
- 77 02 217 509
- 5- 77 51 465 608

40.10.1

P.R. 1233

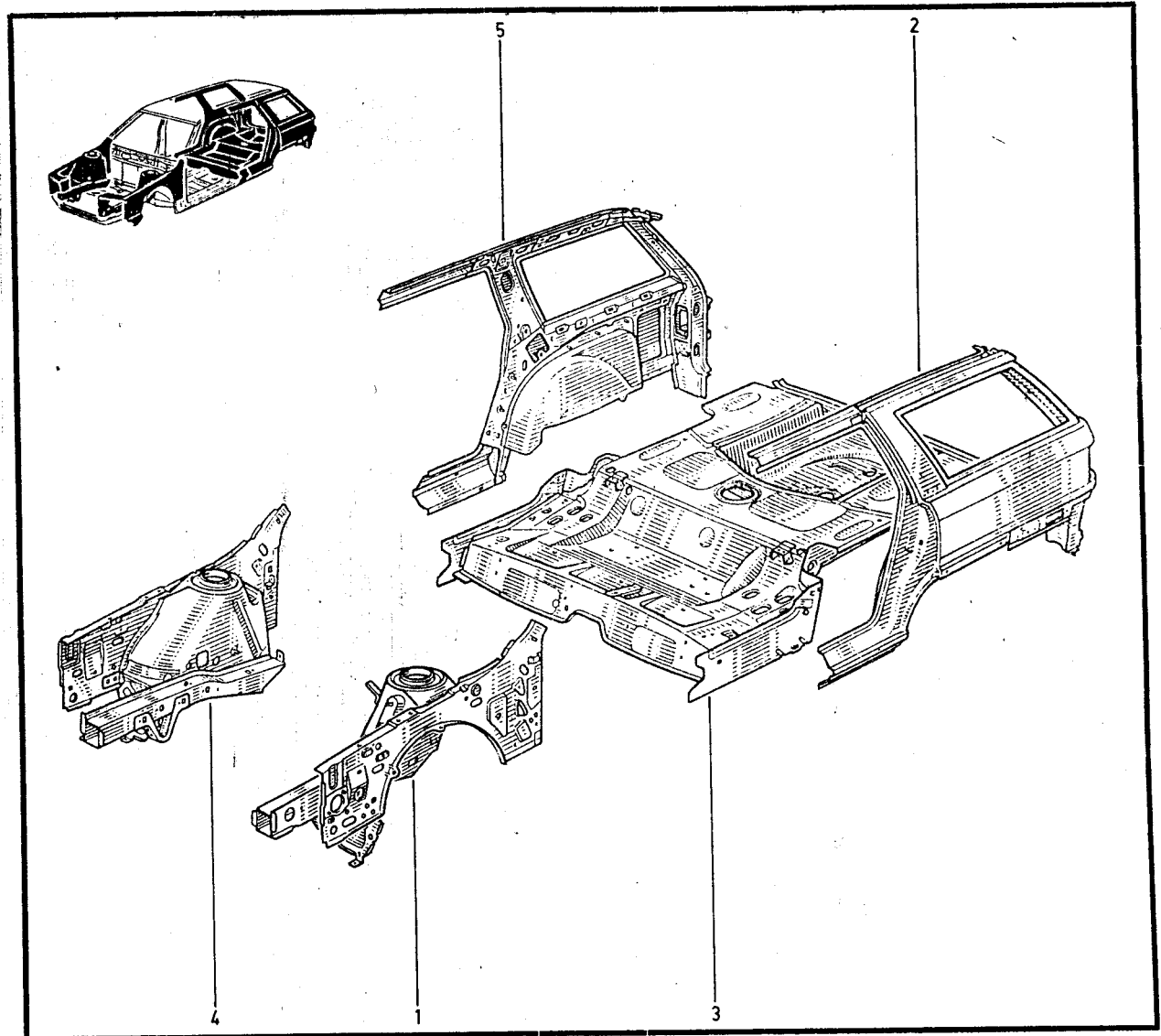

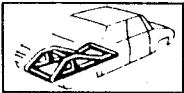

41.10

P.R. 1233

- 1-77 51 464 773
- 2-77 51 626 762
- 3-77 51 464 772
- 4-77 51 626 764
- 5-77 50 764 733
- 6-77 50 768 420
- 7-77 50 768 740
- 8-77 50 784 494
- 9-77 50 765 887
- 10-77 50 760 095
- 11-77 50 754 058
- 12-77 50 784 495
- 13-77 50 765 888
- 14-77 50 760 097
- 15-77 50 754 078
- 16-77 50 785 342
- 17-77 50 772 927
- 18-77 50 772 928
- 19-77 03 002 008
- 20-77 00 783 144
- 21-77 00 783 145

41.10

P.R. 1233

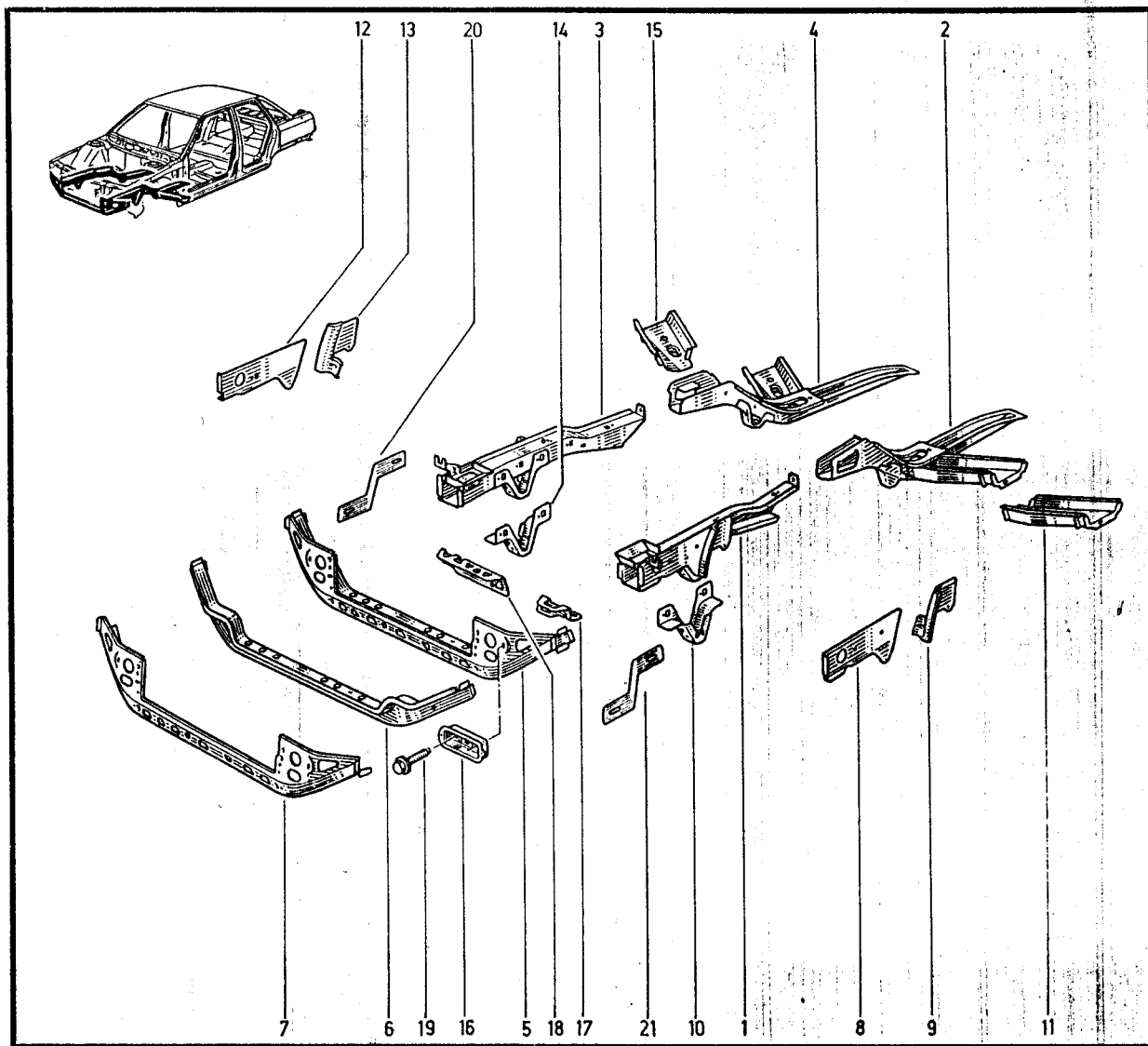
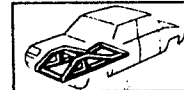

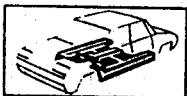

41.20
P.R. 1233

- 1-77 50 761 437
- 2-77 50 753 483
- 3-77 50 753 485
- 4-77 50 761 161
- 5-77 50 761 165
- 6-77 50 761 163
- 7-77 50 761 167
- 8-77 03 072 213

41.20
P.R. 1233

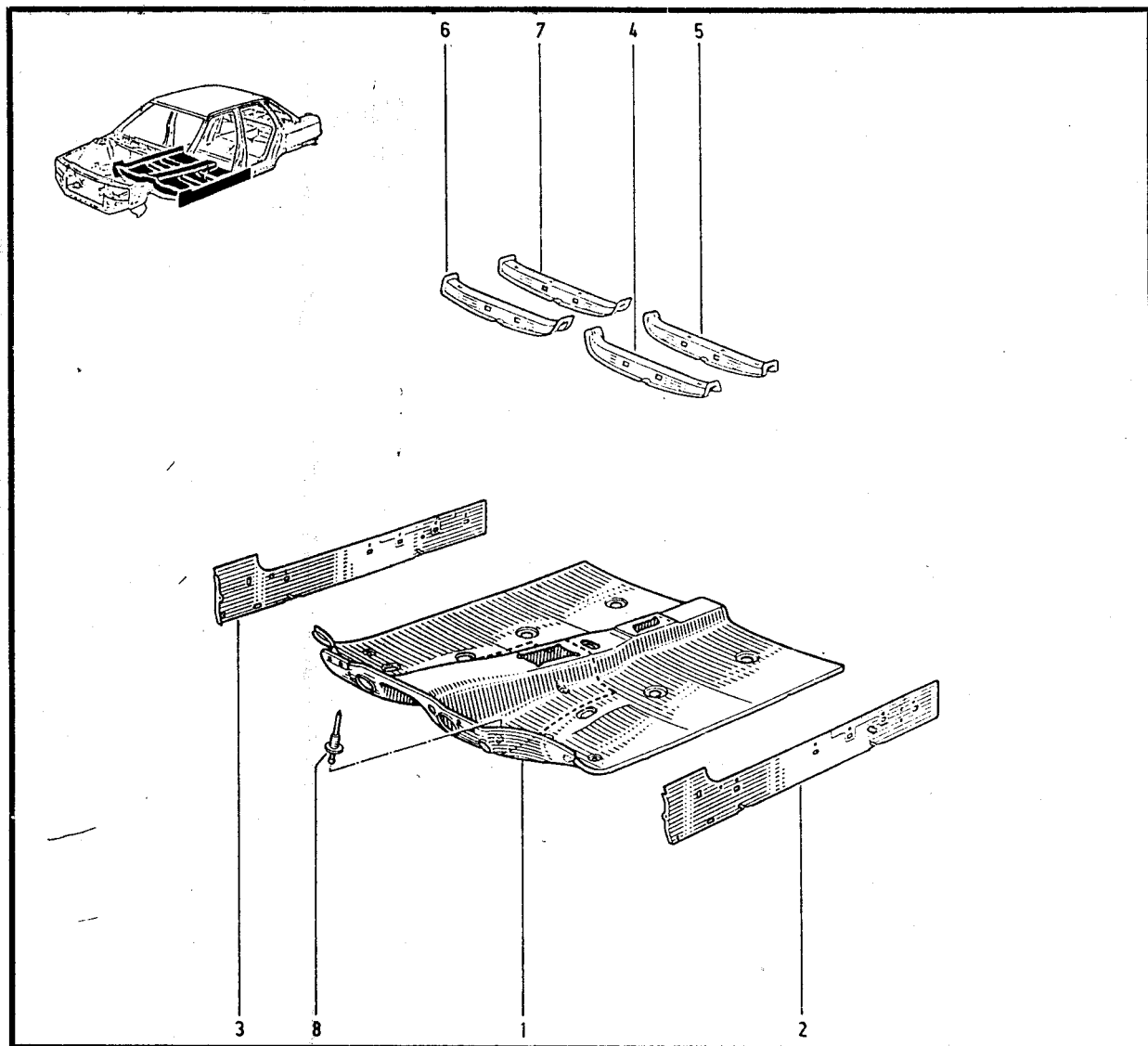
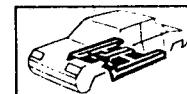

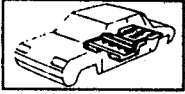

41.30.1

P.R. 1233

41.30.1

P.R. 1233



- 1- 77 51 629 117
- 77 51 465 633
- 2- 77 50 763 766
- 3- 77 50 769 633 †
- 77 50 823 378
- 4- 77 51 465 634
- 5- 77 50 753 998
- 6- 77 50 768 474
- 7- 77 50 774 031
- 8- 77 51 629 114
- 9- 77 50 763 648
- 10- 77 51 630 403
- 11- 77 50 771 962
- 12- 77 00 766 669
- 13- 77 02 098 678
- 14- 77 00 774 041
- 15- 77 03 001 160
- 16- 77 03 072 213
- 17- 77 50 768 214
- 18- 77 03 082 025

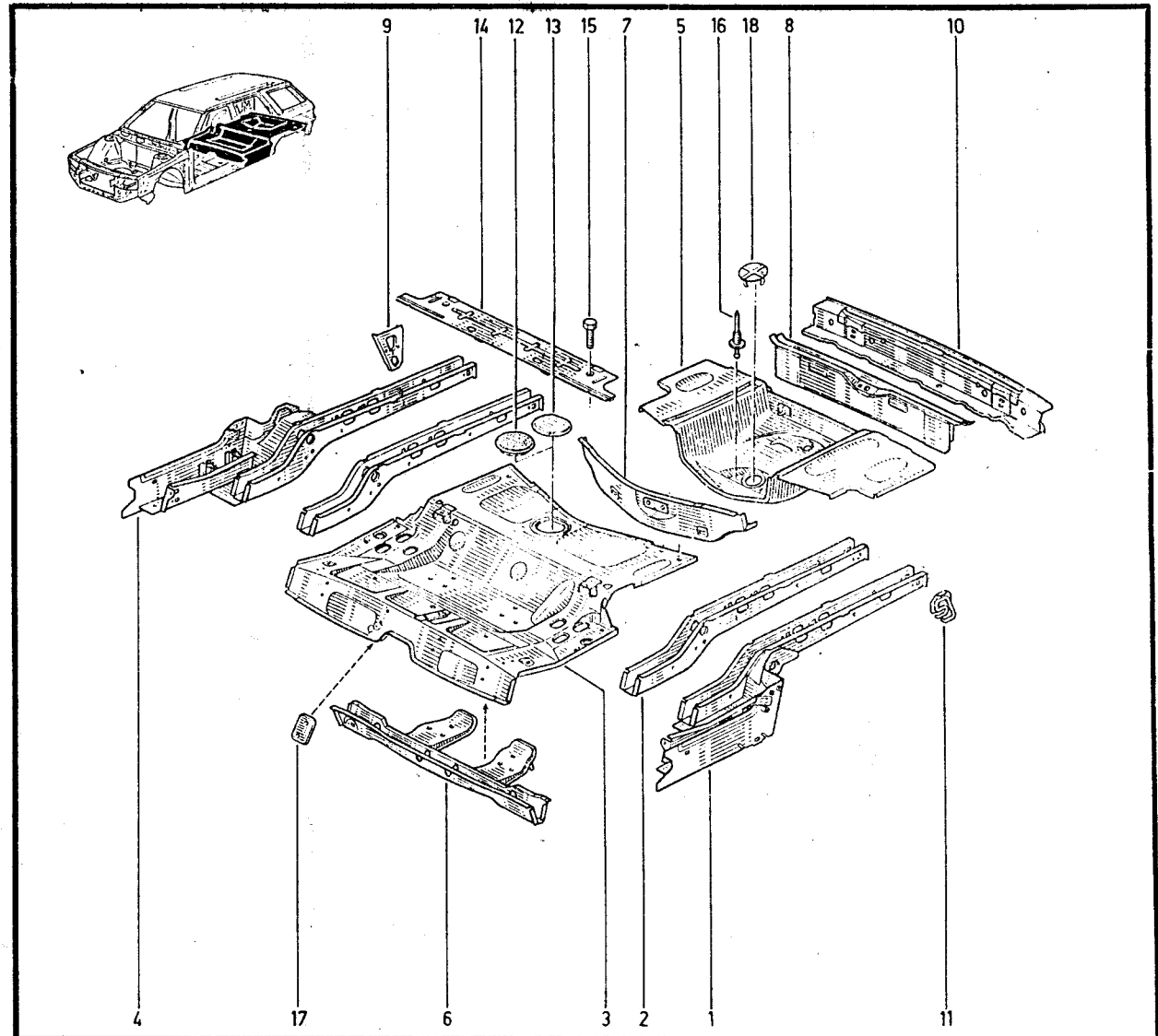

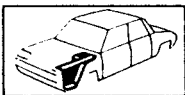

42.01

P.R. 1233

42.01

P.R. 1233

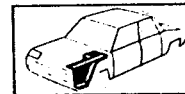

- 1- 77 02 206 107
- 2- 77 51 626 954
- 3- 77 02 206 109
- 4- 77 51 654 072
- 5- 77 02 206 106
- 6- 77 51 626 955
- 7- 77 02 206 108
- 8- 77 51 454 073
- 9- 77 50 777 569
- 10- 77 03 002 058
- 11- 77 50 762 099
- 12- 77 01 464 299
- 13- 77 01 464 300
- 14- 77 50 766 439
- 15- 77 50 770 683
- 16- 77 50 770 684
- 17- 77 00 765 608
- 18- 77 02 094 580
- 19- 77 03 033 033
- 20- 77 03 044 112
- 21- 77 02 094 579
- 22- 77 50 776 277
- 23- 77 50 776 363
- 24- 77 50 826 889
- 25- 77 03 001 122
- 26- 77 03 046 048
- 27- 77 50 785 991
- 28- 77 50 785 990

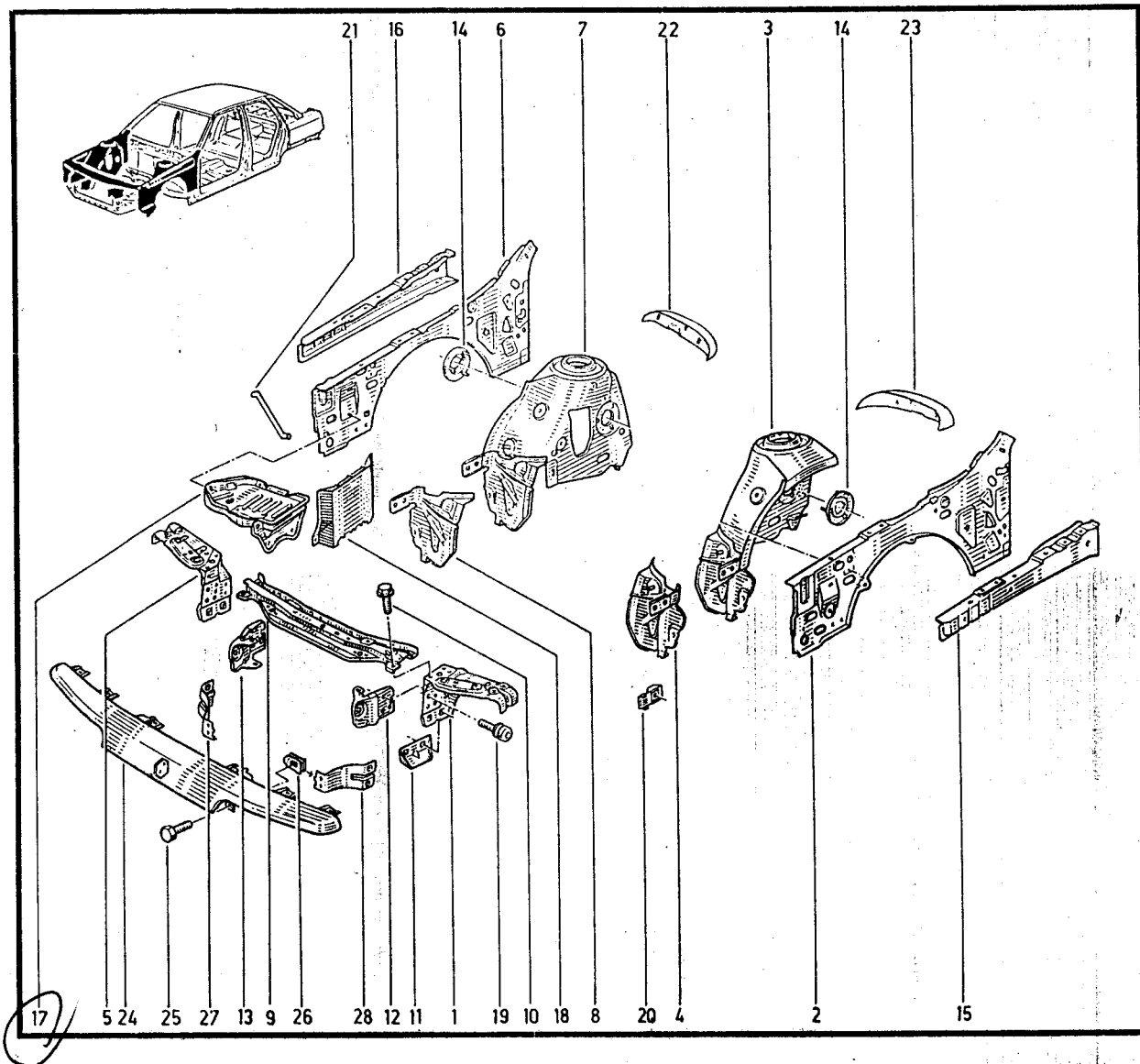

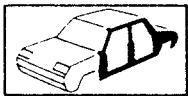

43.01

P.R. 1233

43.01

P.R. 1233



- 1- 77 51 465 469 †
- 77 02 217 393
- 2- 77 01 463 743
- 3- 77 51 465 471
- 4- 77 01 463 751
- 5- 77 51 640 413
- 6- 77 01 463 747
- 7- 77 01 463 749
- 8- 77 51 465 470 †
- 77 02 217 392
- 9- 77 01 463 744
- 10- 77 51 465 472
- 11- 77 01 463 752
- 12- 77 51 640 414
- 13- 77 01 463 748
- 14- 77 01 463 750
- 15- 77 50 761 581
- 16- 77 50 761 582
- 17- 77 05 029 020
- 18- 77 05 029 021
- 19- 77 50 771 546
- 20- 77 00 771 771
- 21- 77 03 088 069
- 22- 77 03 033 027
- 23- 77 03 088 070

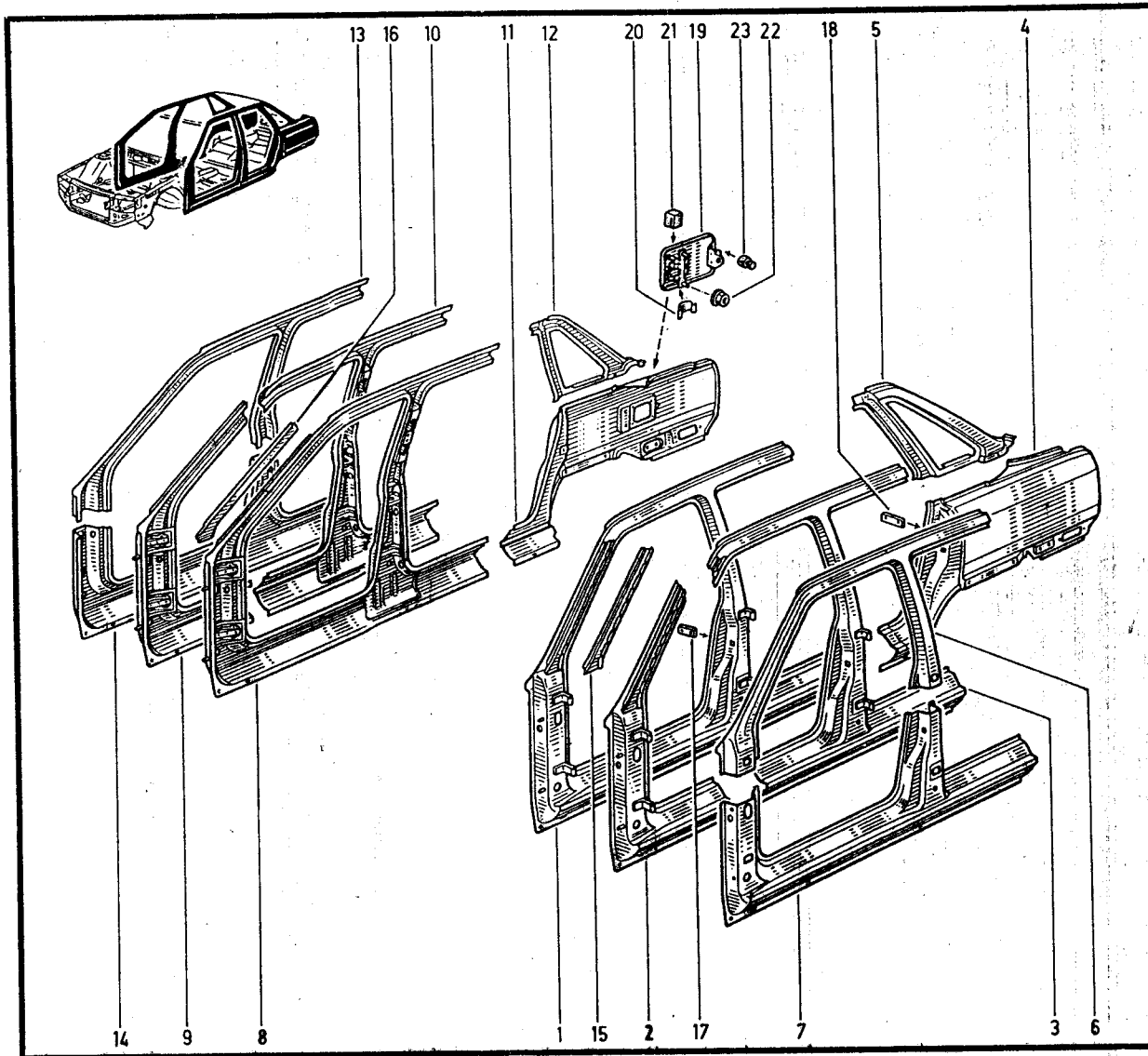

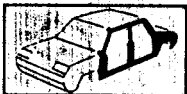

43.01.1
P.R. 1233

43.01.1
P.R. 1233

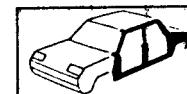

- 1- 77 51 465 469 †
- 77 02 217 393
- 2- 77 01 463 743
- 3- 77 51 465 471
- 4- 77 50 765 520
- 5- 77 51 465 605
- 6- 77 01 463 747
- 7- 77 01 463 749
- 8- 77 51 465 470 †
- 77 02 217 396
- 9- 77 01 463 744
- 10- 77 51 465 472
- 11- 77 50 765 521
- 12- 77 51 465 082
- 13- 77 01 463 748
- 14- 77 01 463 750
- 15- 77 50 761 581
- 16- 77 50 761 582
- 17- 77 05 029 020
- 18- 77 05 029 021
- 19- 77 50 771 546
- 20- 77 00 771 771
- 21- 77 03 088 069
- 22- 77 03 033 027
- 23- 77 03 088 070
- 24- 77 50 766 324
- 25- 77 50 766 323
- 26- 77 51 631 732
- 27- 77 51 631 731

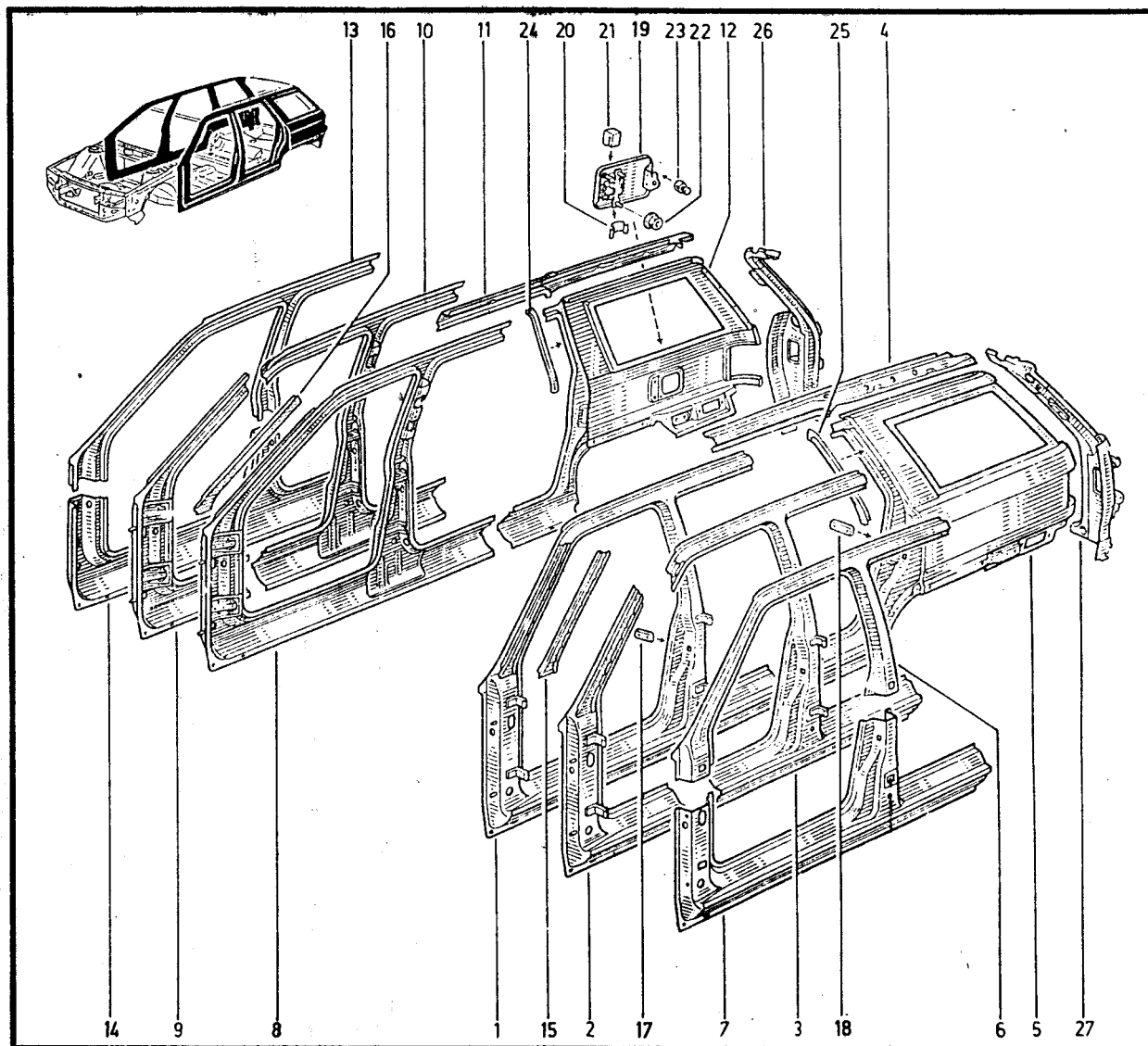



43.10

P.R. 1233

43.10

P.R. 1233

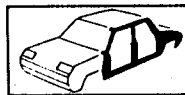

- 1- 77 51 631 740
- 2- 77 50 793 649
- 3- 77 51 647 776
- 4- 77 51 631 741
- 5- 77 50 793 650
- 6- 77 51 647 777
- 7- 77 51 464 499
- 8- 77 50 759 562

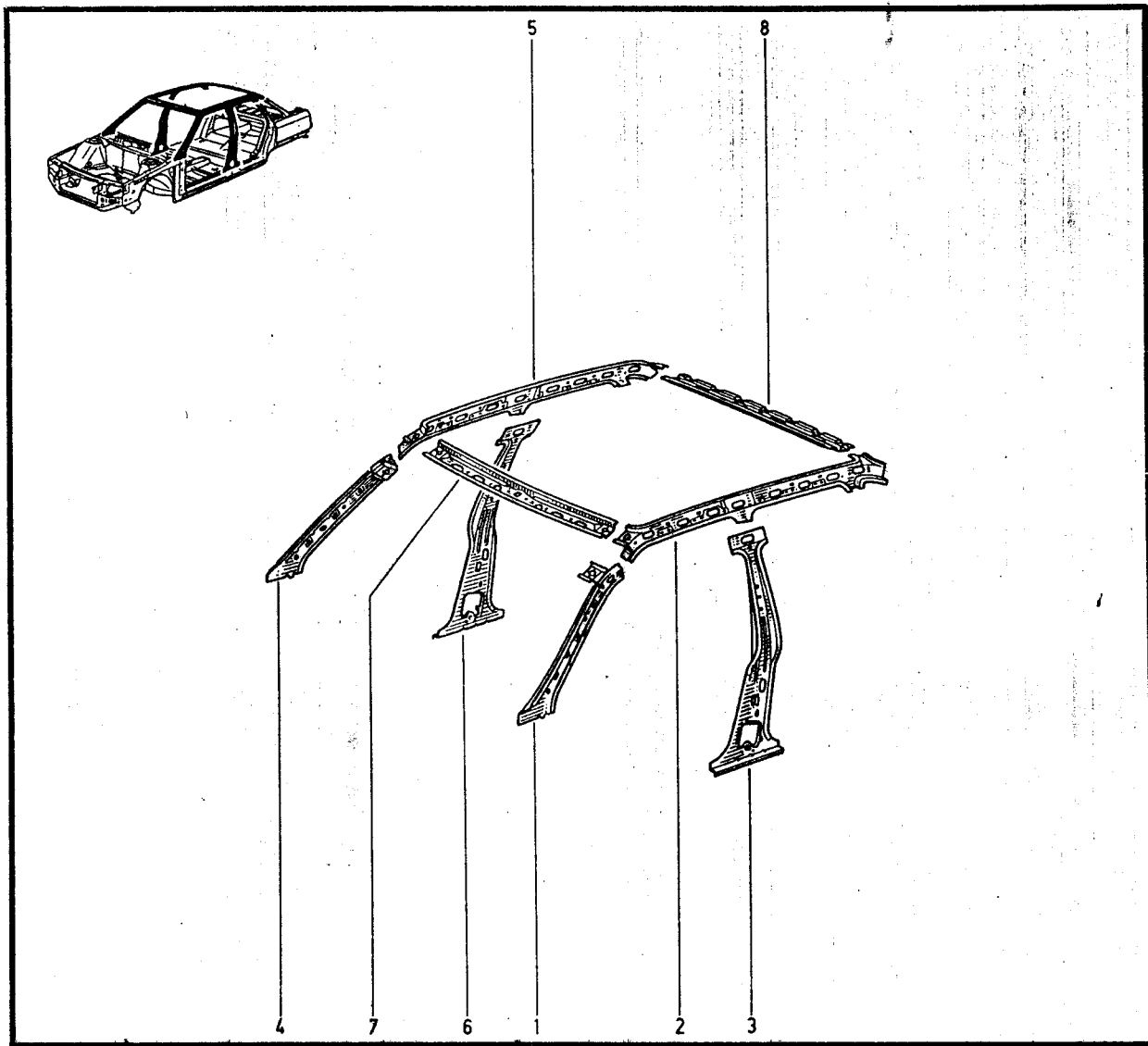

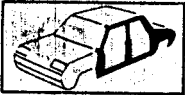

43.10.1

P.R. 1233

43.10.1

P.R. 1233

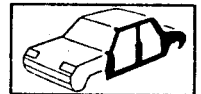

- 1 - 77 51 631 740
- 2 - 77 50 793 576
- 3 - 77 51 647 776
- 4 - 77 51 631 741
- 5 - 77 51 629 082
- 6 - 77 51 647 777
- 7 - 77 51 464 499
- 8 - 77 50 766 146
- 9 - 77 50 793 577
- 10 - 77 51 629 070
- 11 - 77 51 628 509
- 12 - 77 51 629 081
- 13 - 77 50 773 523
- 14 - 77 50 773 522
- 15 - 77 50 773 525
- 16 - 77 50 773 524

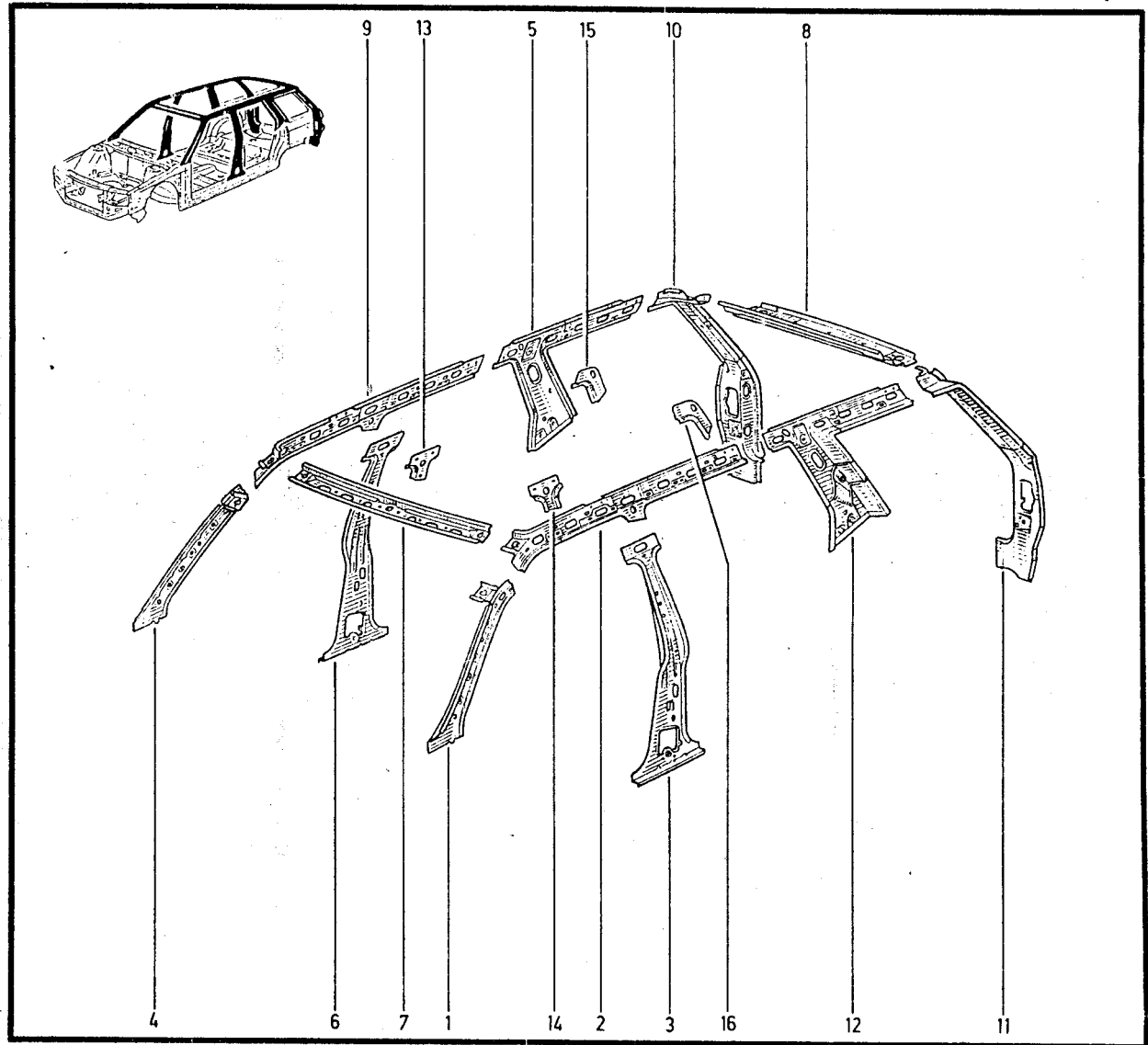

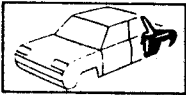

44.01

P.R. 1233

44.01

P.R. 1233

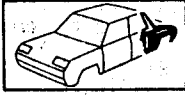

- 1- 77 51 626 732
- 2- 77 50 764 009
- 3- 77 50 770 321
- 4- 77 51 631 742
- 5- 77 51 626 969
- 6- 77 51 626 733
- 7- 77 50 764 010
- 8- 77 50 770 322
- 9- 77 51 631 743

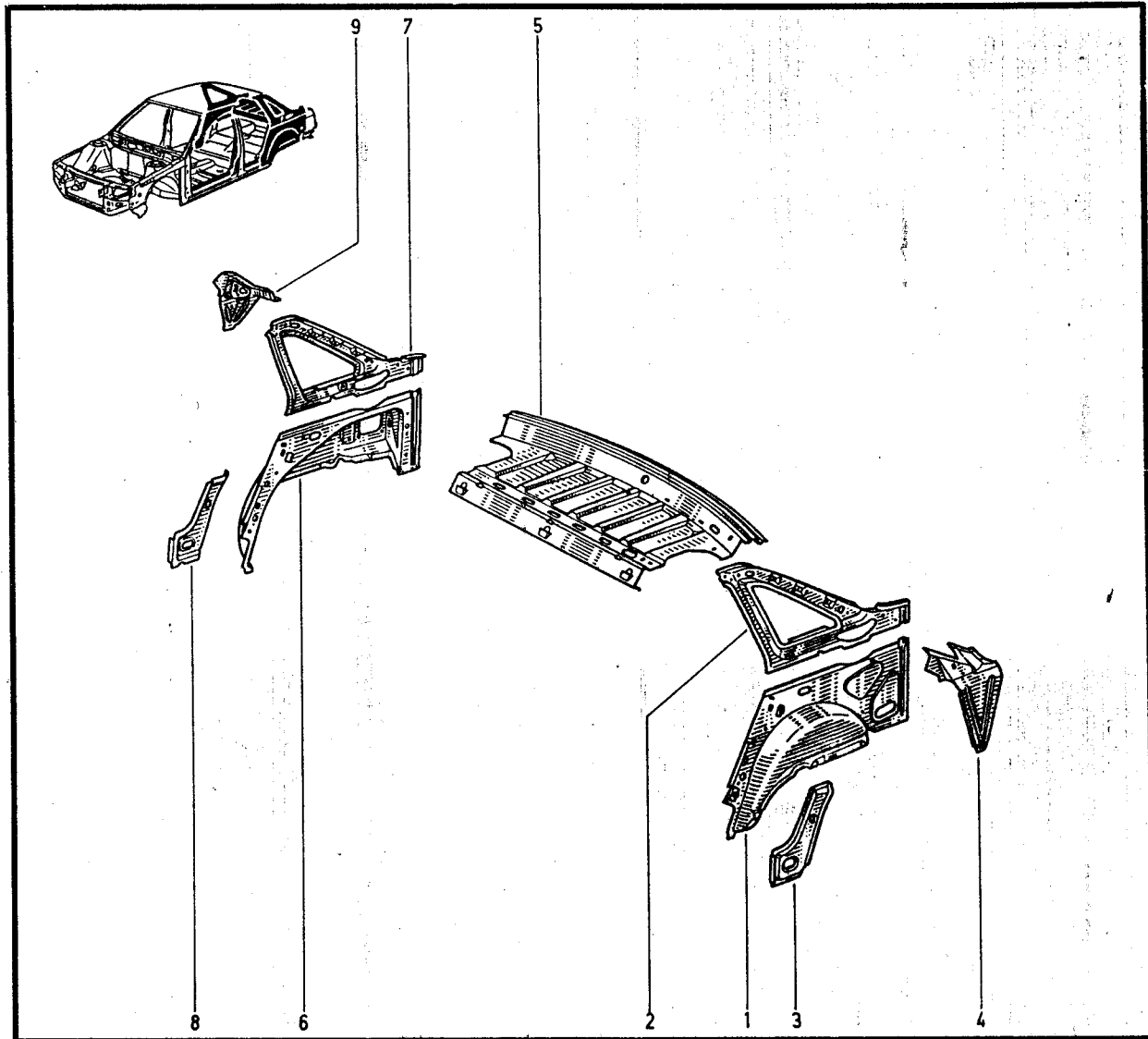



44.01.1

P.R. 1233

- 1 - 77 51 465 606
- 2 - 77 51 464 188
- 3 - 77 50 760 645
- 4 - 77 50 760 646

44.01.1

P.R. 1233

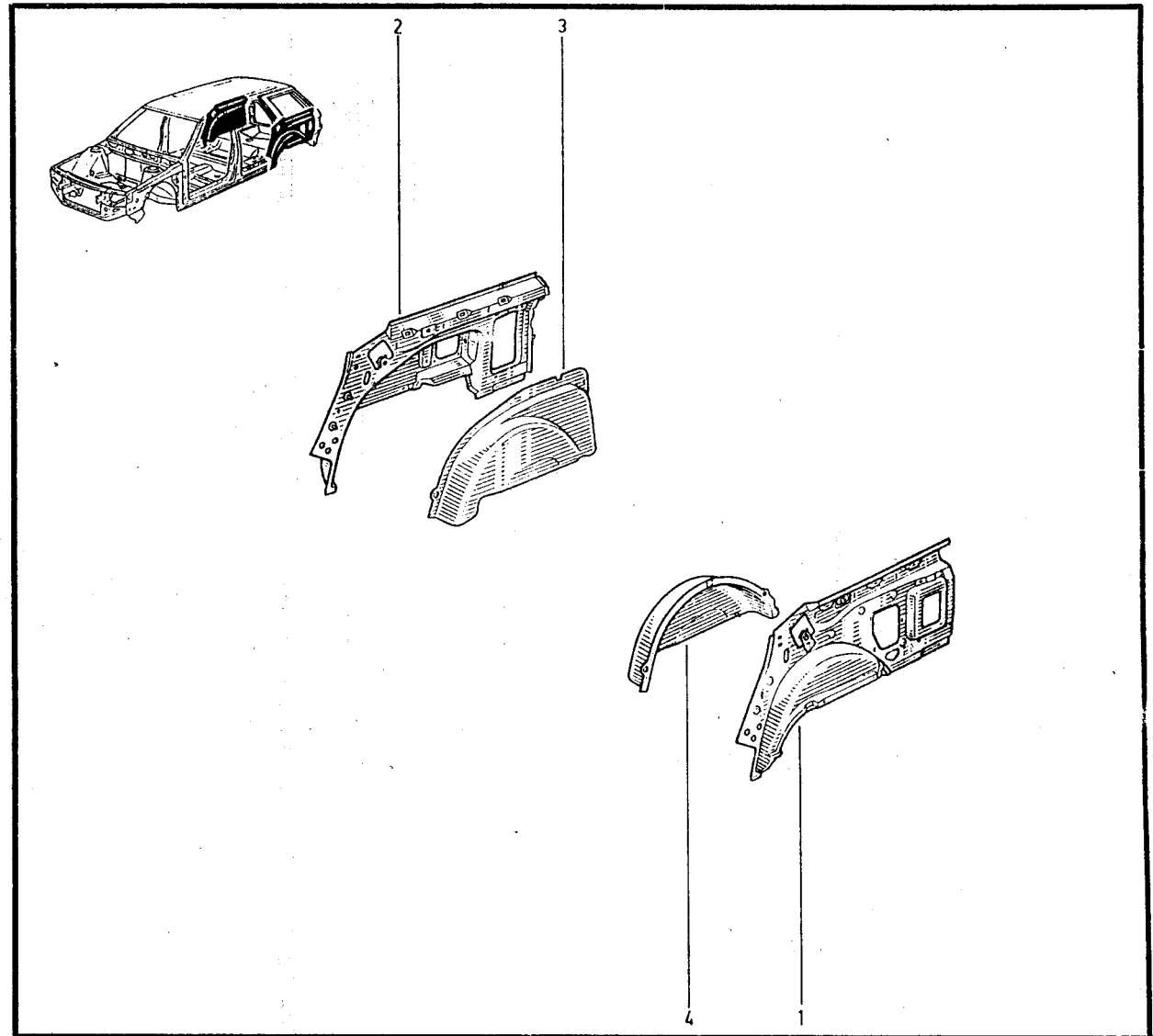
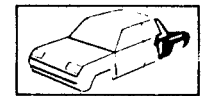

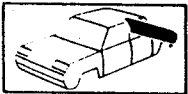

44.20

P.R. 1233

- 1- 77 50 785 678
- 2- 77 51 465 596
- 3- 77 51 647 793
- 4- 77 51 647 794

44.20

P.R. 1233

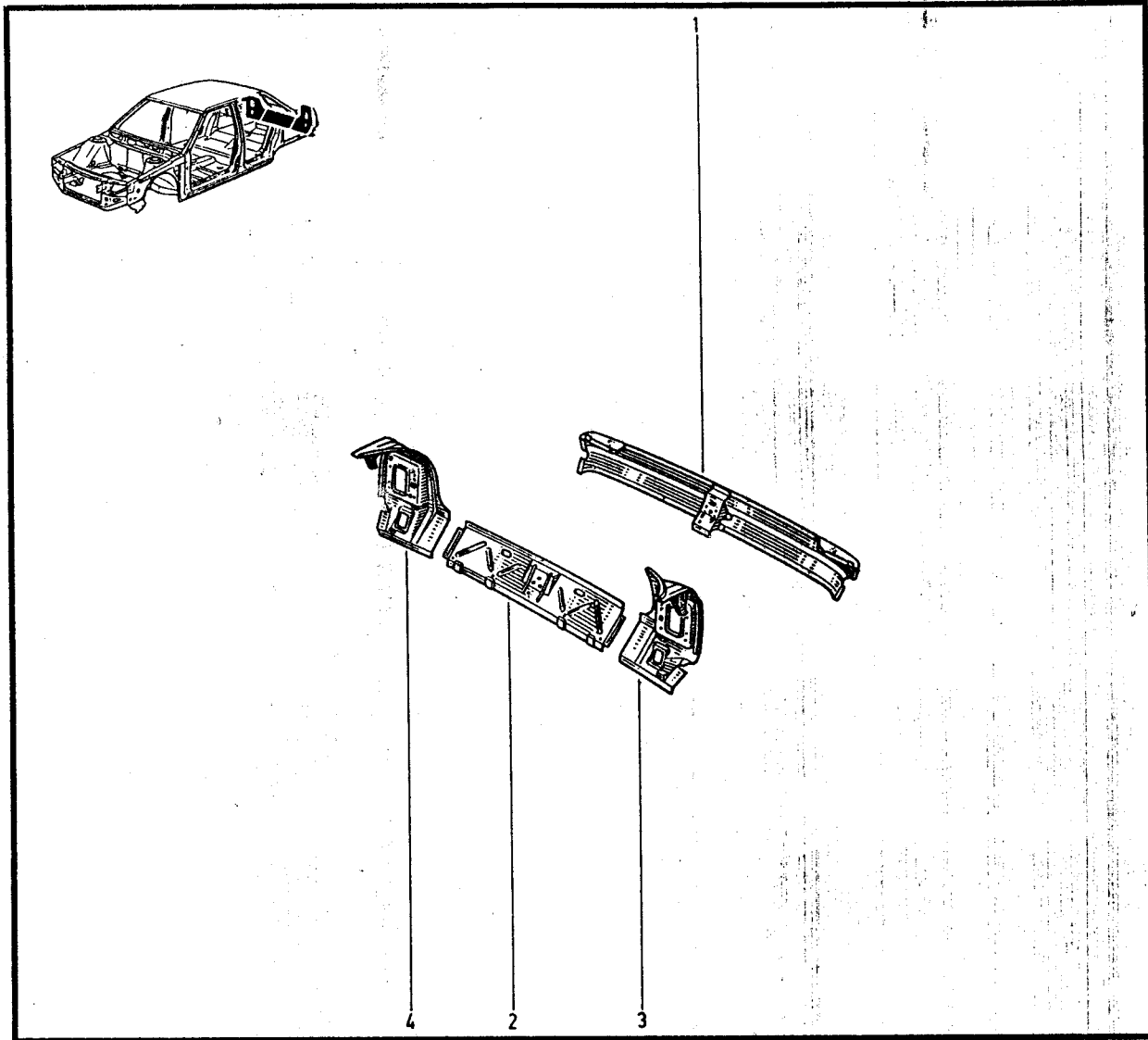
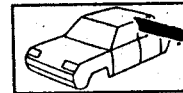

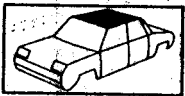

45.01
P.R. 1233

45.01
P.R. 1233



1- 77 50 760 680 ⇌ (a)
2- 77 51 466 720 ⇌ (b)

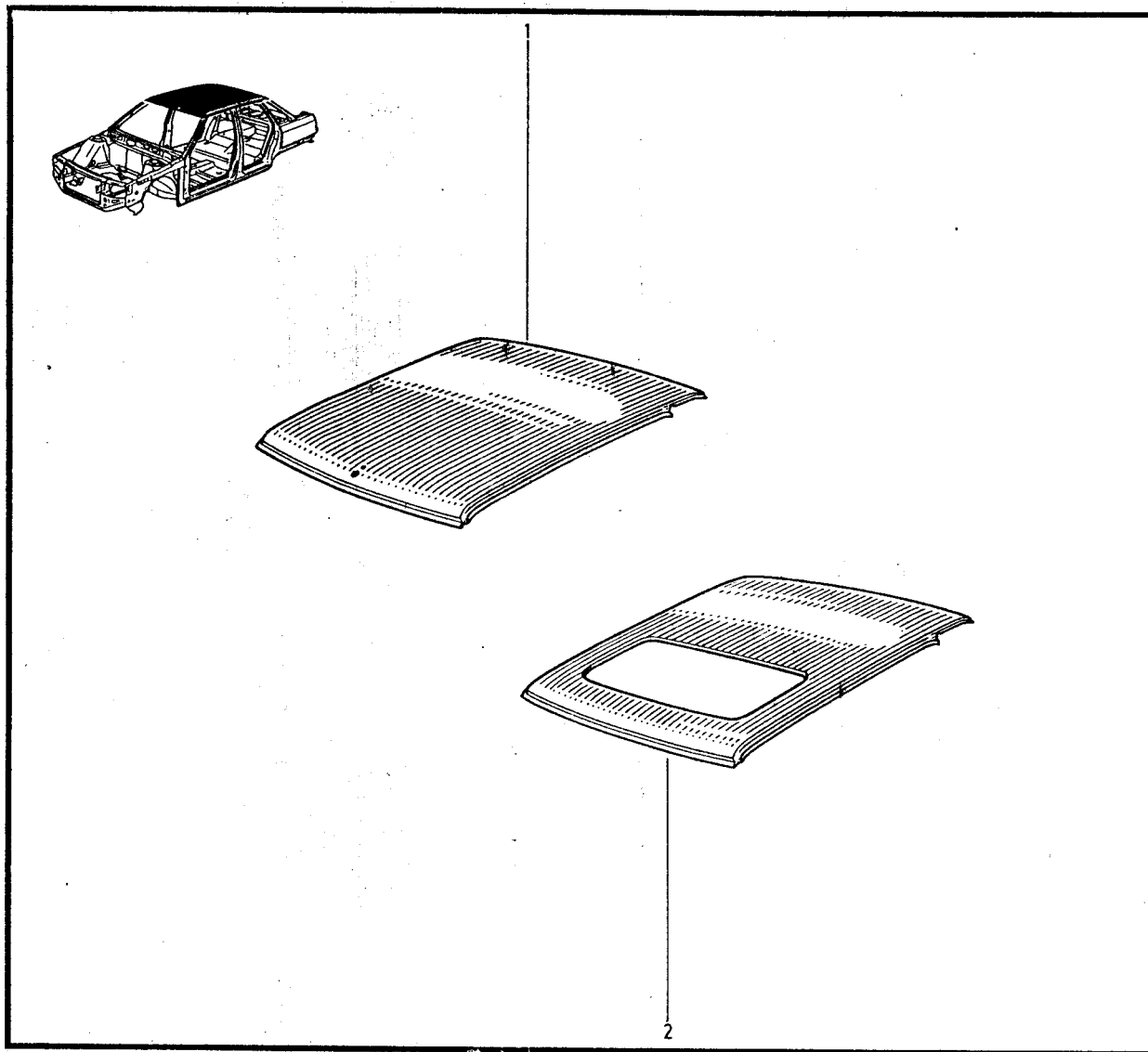

(a) L488 089
L48G 202
L48S 090
L48Y 090
L48Z 096

(b) L48X 208
L48Z 091
L48Z 095
L48S 091
L48Y 091
L48K 209

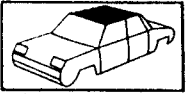

45.01.1
P.R. 1233

- 1 - 77 01 464 314
- 2 - 77 02 099 089
- 3 - 77 50 783 932
- 4 - 77 02 099 090
- 5 - 77 03 044 087
- 6 - 77 03 006 106

45.01.1
P.R. 1233

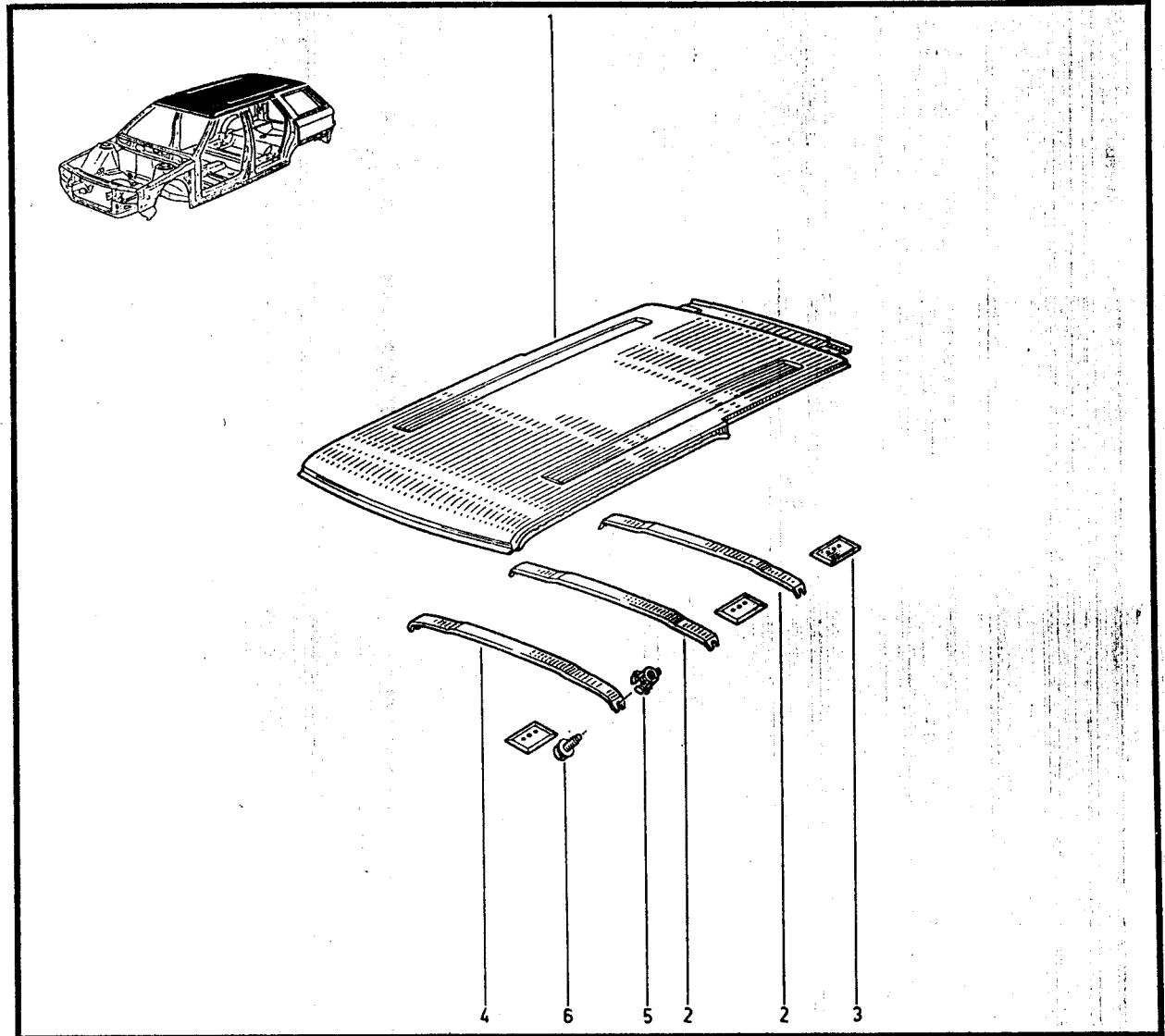
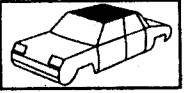

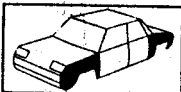

46.01

P.R. 1233

- 1-77 02 206 811
- 2-77 02 206 812
- 3-77 03 035 011
- 4-77 03 001 865
- 77 03 002 020

46.01

P.R. 1233

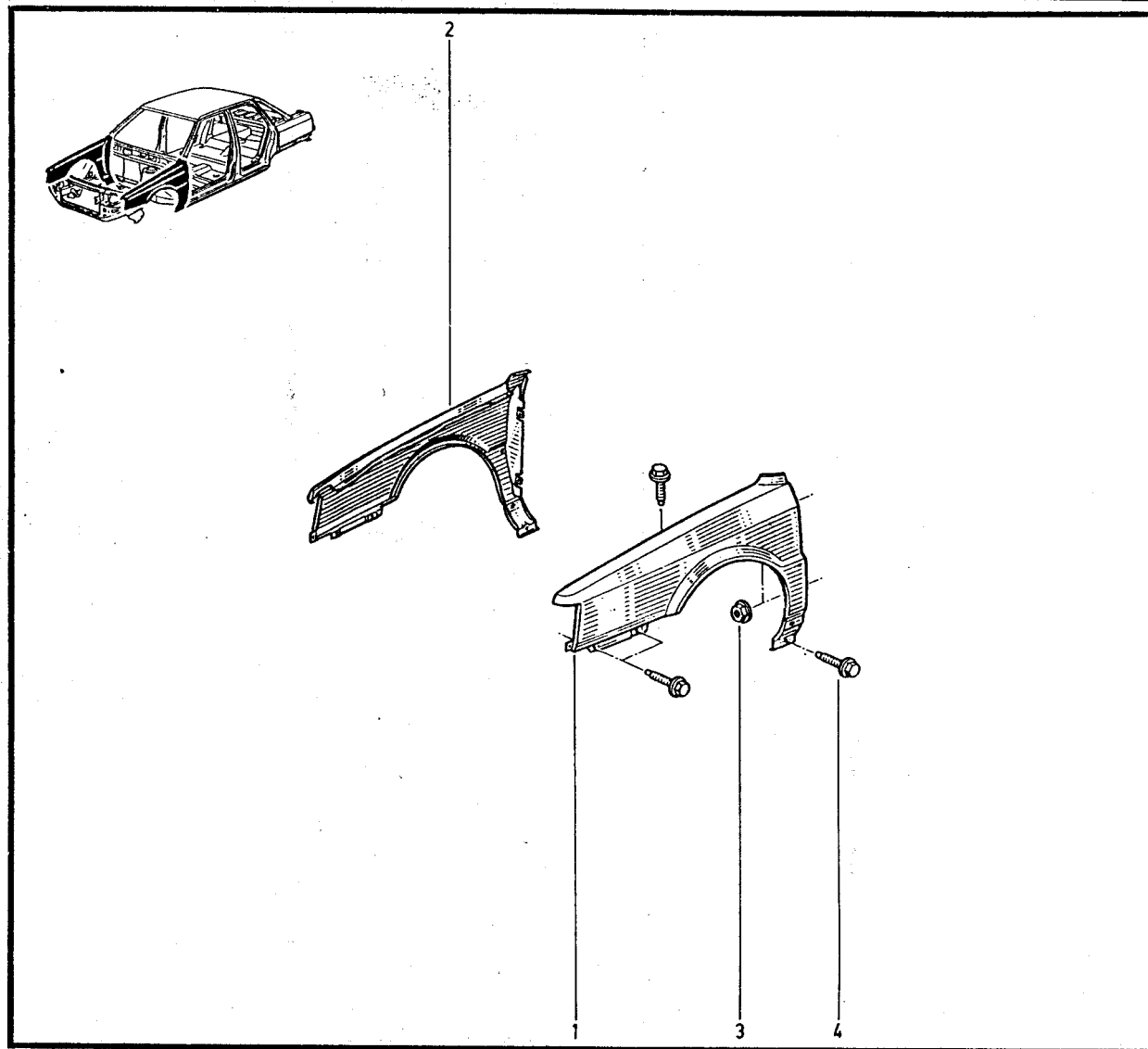
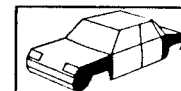

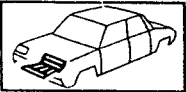

46.10

P.R. 1233

46.10

P.R. 1233

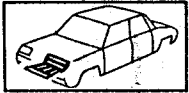

- 1- 77 00 763 109
- 2- 77 00 704 480
- 3- 77 00 704 479
- 4- 77 02 094 793
- 5- 77 00 784 917
- 77 00 777 437
- 6- 77 00 784 918
- 77 00 784 304
- 7- 77 00 786 688 (ABS)
- 8- 77 00 786 689 (ABS)
- 9- 77 00 776 500
- 10- 77 00 782 217
- 11- 77 00 782 215
- 12- 77 00 771 672
- 13- 77 00 776 627
- 14- 77 00 774 000 (a)
- 15- 77 03 058 045 (a)
- 16- 77 03 001 158 (a)
- 17- 77 03 044 094 (a)
- 18- 77 02 094 445 (a)
- 19- 77 02 094 411
- 20- 77 03 072 046

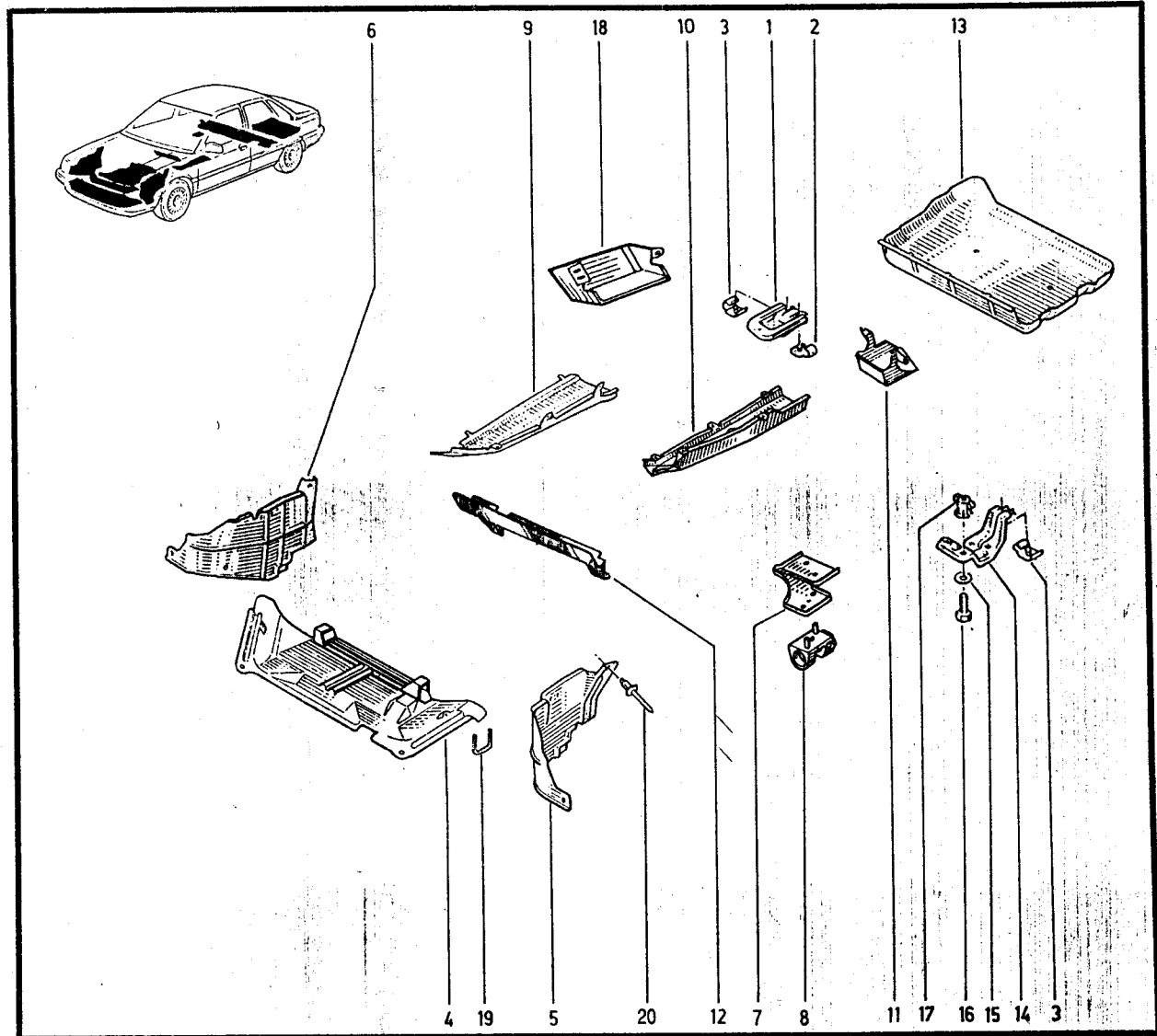

	K48Y 090/092
	K48S 090/092
(a)	K488 089- K487
	K48G 202
	K48X 210



48.05.1

P.R. 1233

- 1- 77 51 465 359
- 2- 77 02 206 913
- 3- 77 01 639 510
- 4- 77 01 639 511
- 5- 77 03 001 904
- 6- 77 03 056 083
- 7- 77 00 775 035
- 8- 77 03 073 222
- 9- 77 50 805 979
- 10- 77 50 805 980
- 11- 77 00 775 466
- 12- 77 00 775 465
- 13- 77 03 101 160
- 14- 77 03 088 015
- 15- 77 03 002 022
- 16- 77 00 785 658
- 17- 77 03 033 033
- 18- 77 00 634 996

48.05.1

P.R. 1233

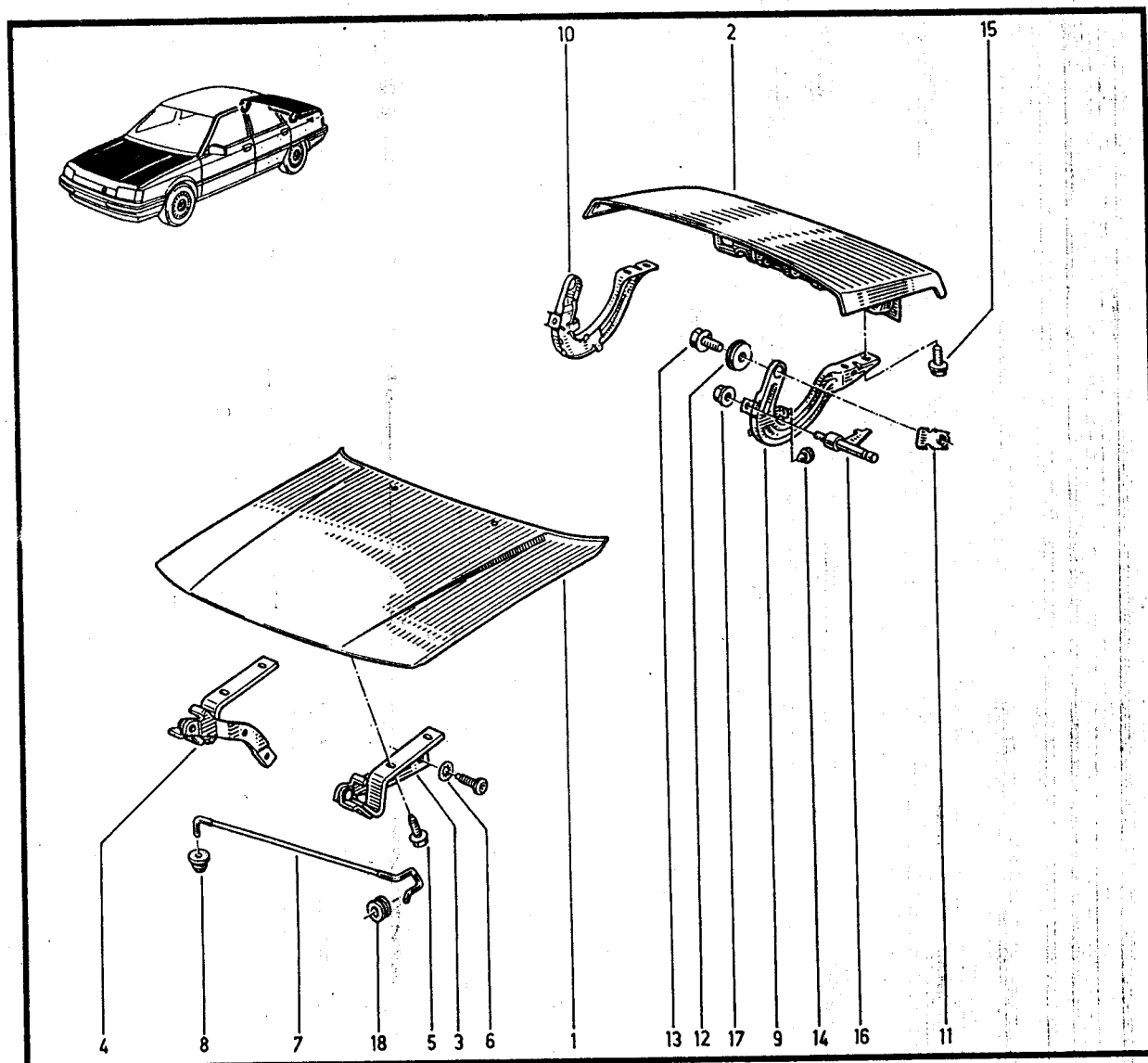

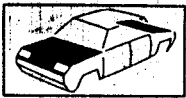

48 . 06

P.R. 1233

48 . 06

P.R. 1233

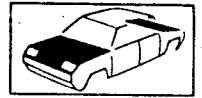

- 1- 77 51 465 359
- 2- 77 02 217 235
- 3- 77 01 639 510
- 4- 77 01 639 511
- 5- 77 03 001 904
- 6- 77 03 056 083
- 7- 77 00 775 035
- 8- 77 03 073 222
- 9- 77 00 804 222
- 10- 77 51 629 126
- 11- 77 03 033 039
- 12- 77 00 767 776
- 77 02 098 685
- 13- 77 00 768 695
- 14- 77 00 634 996

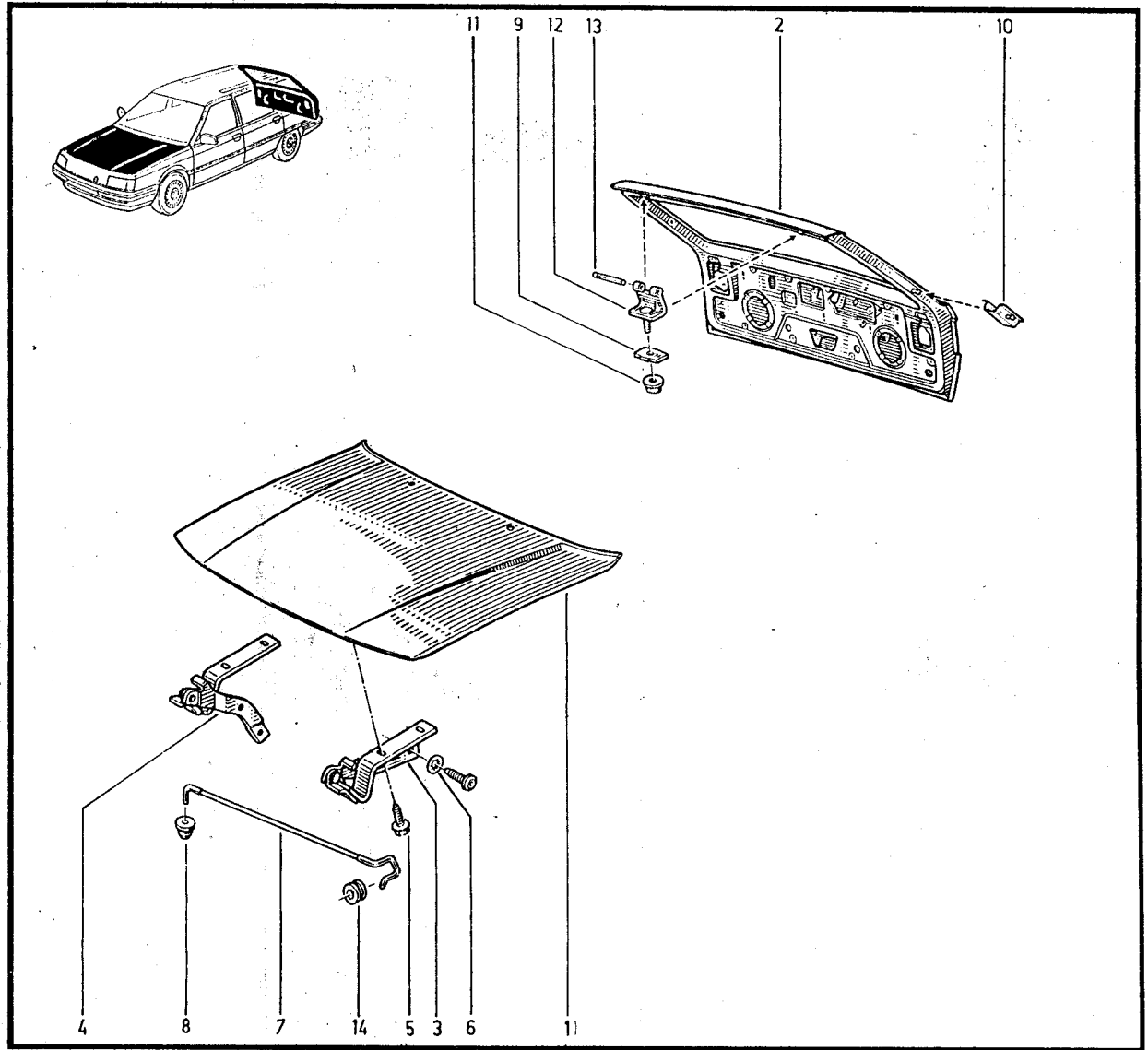



48.05.1

P.R. 1233

- 1- 77 51 465 359
- 2- 77 02 206 913
- 3- 77 01 639 510
- 4- 77 01 639 511
- 5- 77 03 001 904
- 6- 77 03 056 083
- 7- 77 00 775 035
- 8- 77 03 073 222
- 9- 77 50 805 979
- 10- 77 50 805 980
- 11- 77 00 775 466
- 12- 77 00 775 465
- 13- 77 03 101 160
- 14- 77 03 088 015
- 15- 77 03 002 022
- 16- 77 00 785 658
- 17- 77 03 033 033
- 18- 77 00 634 996

48.05.1

P.R. 1233

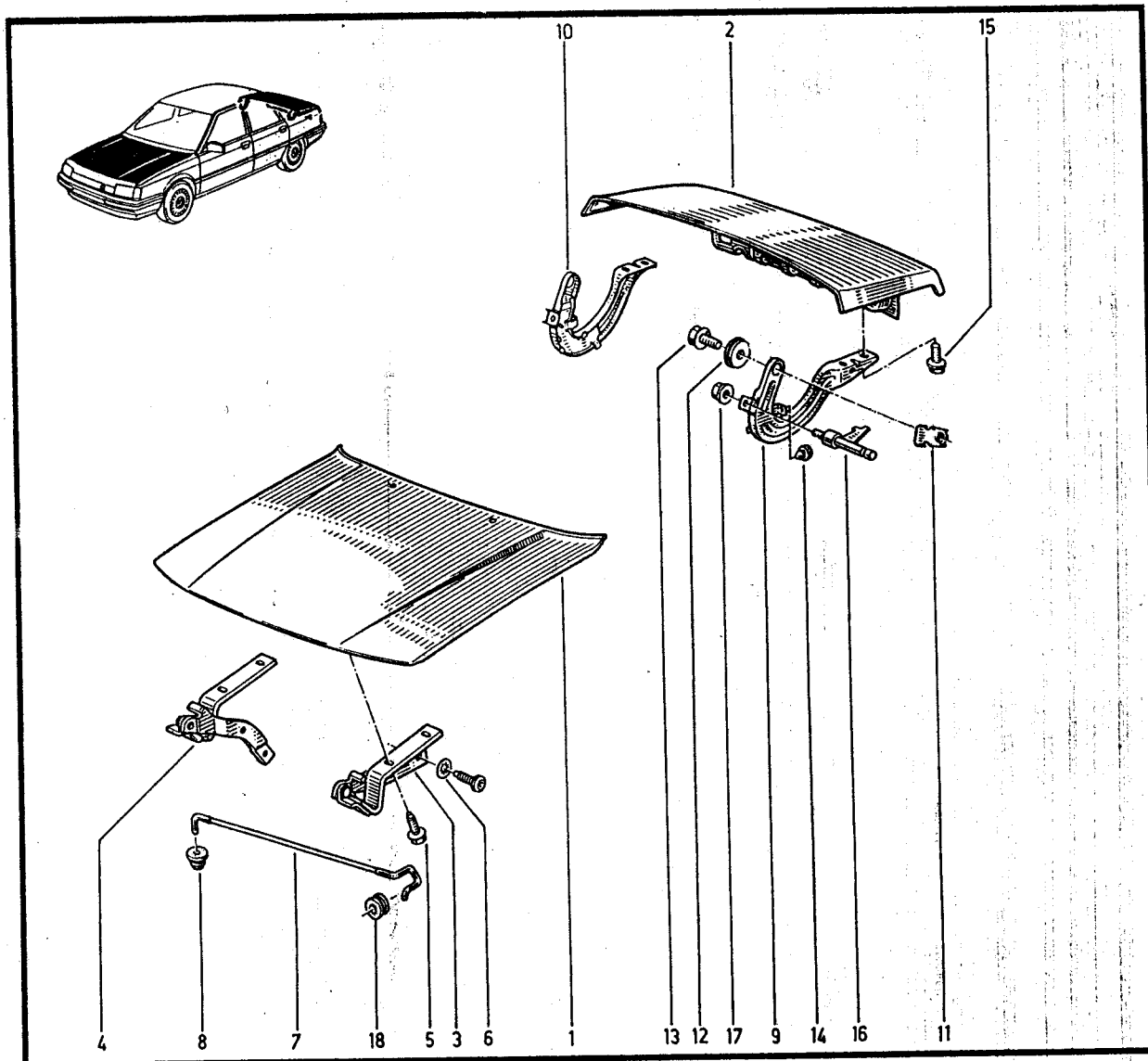
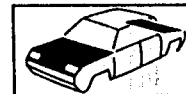

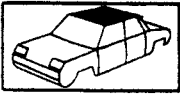

48.10.1
P.R. 1233

1- 77 01 035 828
2- 77 01 035 831 (2x)
77 01 035 829 (2x)



48.10.1
P.R. 1233

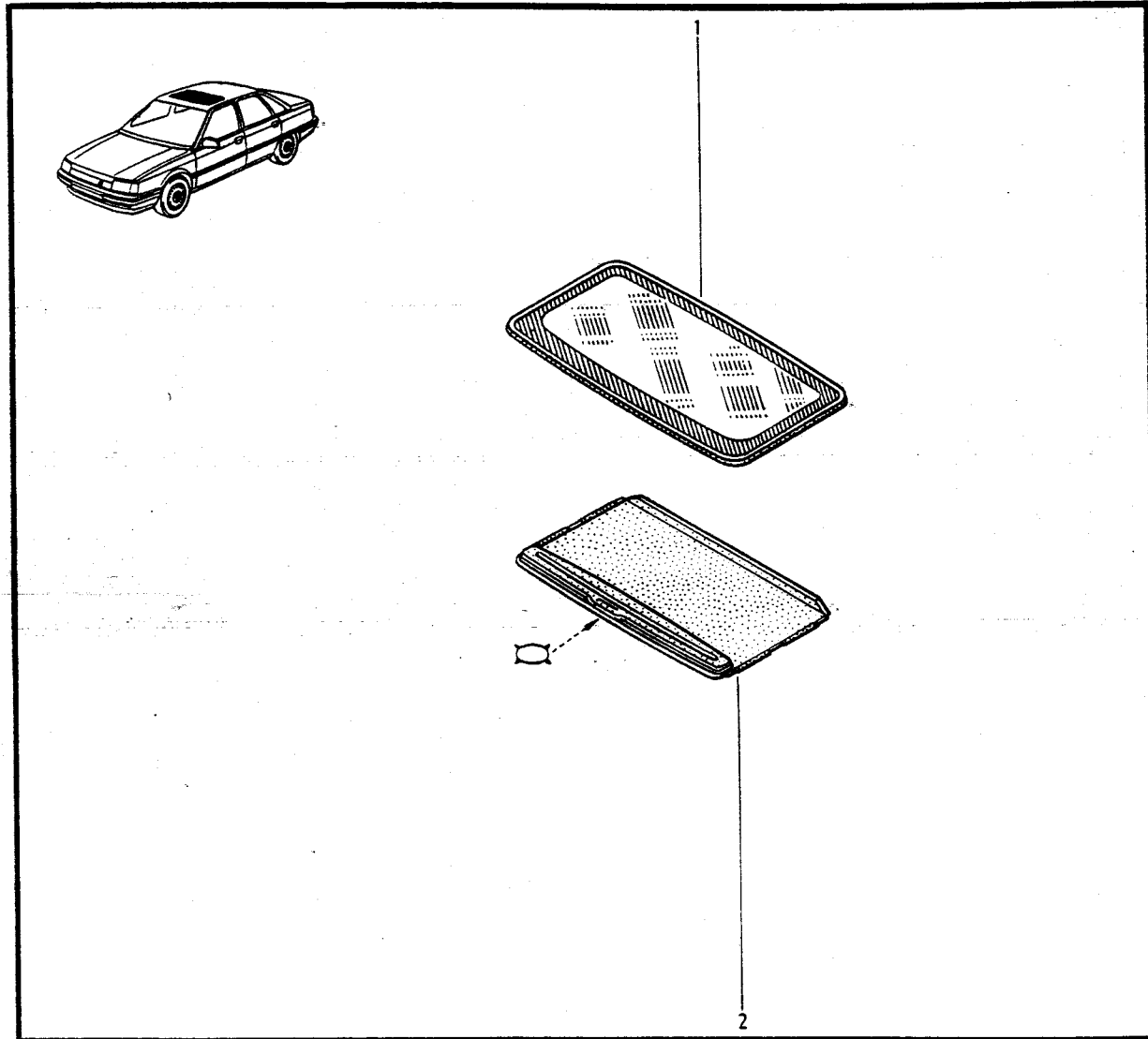
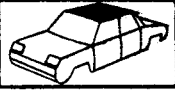

L48X 208
L48Z 091
L48Z 095
L48S 091
L48Y 091
L48K 209

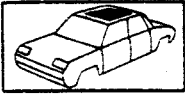

48.15.1

P.R. 1233

- 1- 77 01 035 836
- 2- 77 01 035 834
- 3- 77 01 035 833
- 4- 77 01 035 838
- 5- 77 01 035 839
- 6- 77 01 035 835
- 7- 77 02 098 425
- 8- 77 01 033 495
- 9- 77 00 793 246
- 10- 77 02 098 426



48.15.1

P.R. 1233

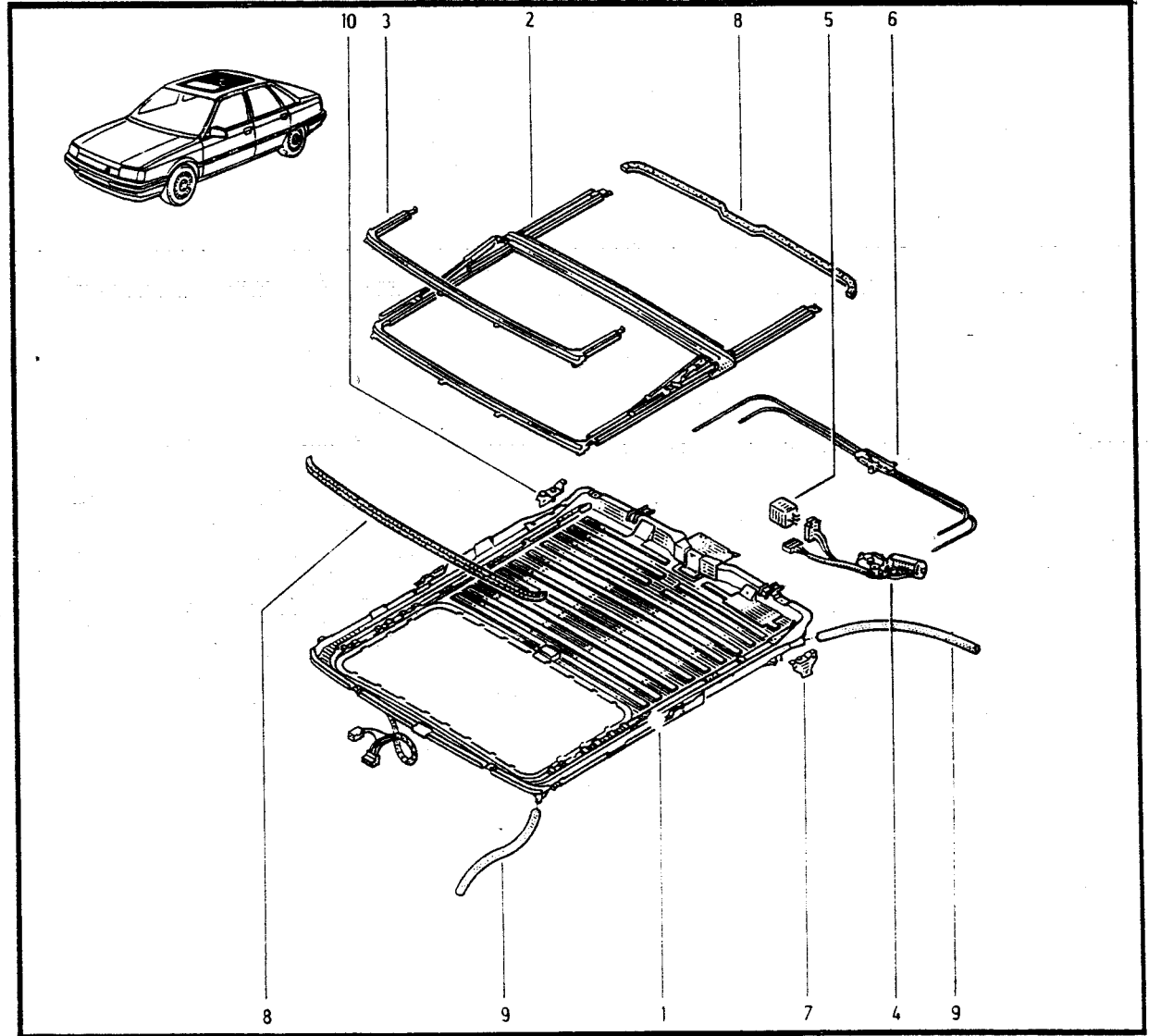
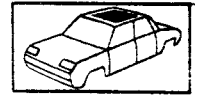

- L48X 208
- L48Z 091
- L48Z 095
- L48S 091
- L48Y 091
- L48K 209

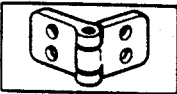

50.01

P.R. 1233

- 1- 77 00 824 055
- 2- 77 03 033 027
- 3- 77 00 784 233
- 4- 77 03 001 904
- 5- 77 03 056 083
- 6- 77 03 067 293
- 7- 77 00 824 056
- 8- 77 01 464 919
- 9- 77 00 792 313
- 10- 77 00 781 413
- 11- 77 00 722 443
- 12- 77 00 722 442
- 13- 77 05 010 084
- 14- 77 03 005 065

50.01

P.R. 1233

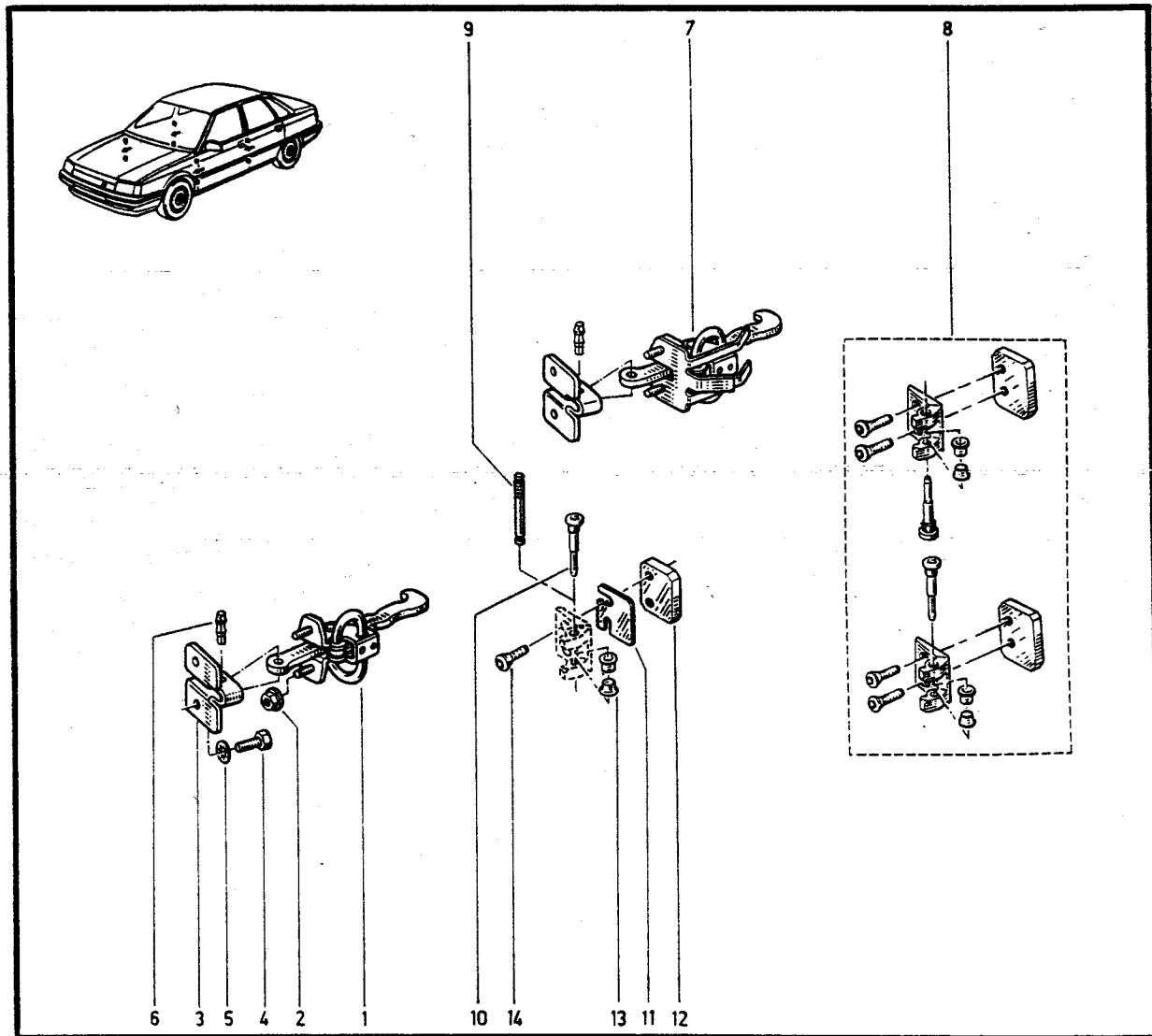
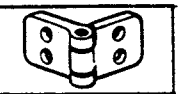



50.10
P.R. 1233

50.10
P.R. 1233



- 1- 77 01 367 308
- 2- 77 01 023 201
- 3- 77 01 034 393
- 4- 77 03 004 077
- 5- 77 01 030 061 ←
- 6- 77 01 030 062 ←
- 7- 77 01 034 489 ←
- 77 01 039 564 ←
- 8- 77 01 029 260 ←
- 9- 77 01 030 058
- 10- 77 01 030 059
- 11- 77 01 034 396
- 12- 77 01 034 489 ←
- 77 01 039 564 ←
- 13- 77 01 033 009 (x=1)

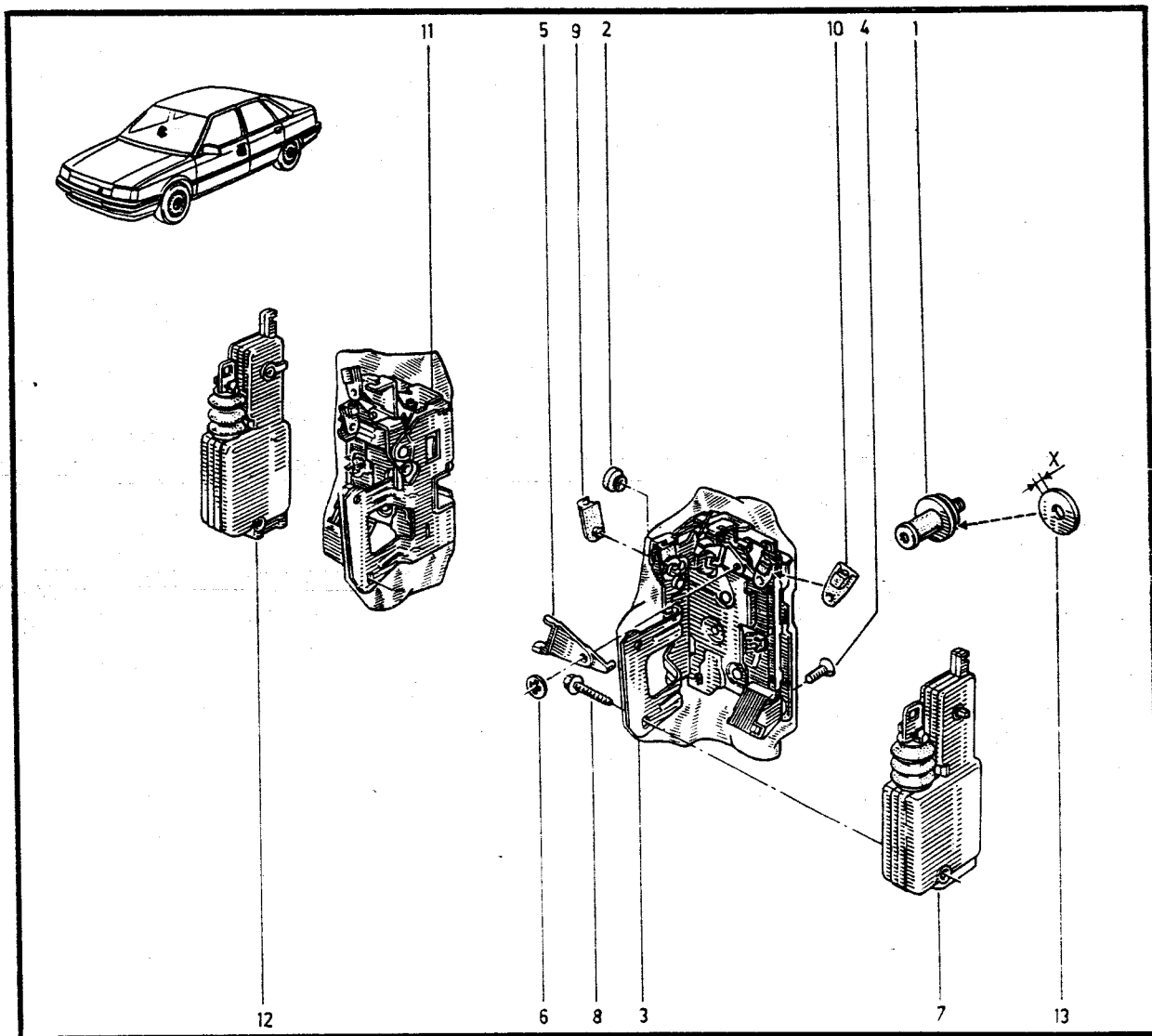

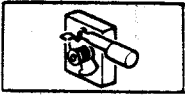

50.20
P.R. 1233

- 1- 77 01 036 308
- 2- 77 01 023 201
- 77 01 034 487
- 4- 77 03 004 077
- 5- 77 01 029 259 \blacktriangle +
- 77 01 039 565 \blacktriangle
- 6- 77 01 029 260 \blacktriangle
- 7- 77 01 034 488
- 8- 77 01 033 009 (x=1)

50.20
P.R. 1233

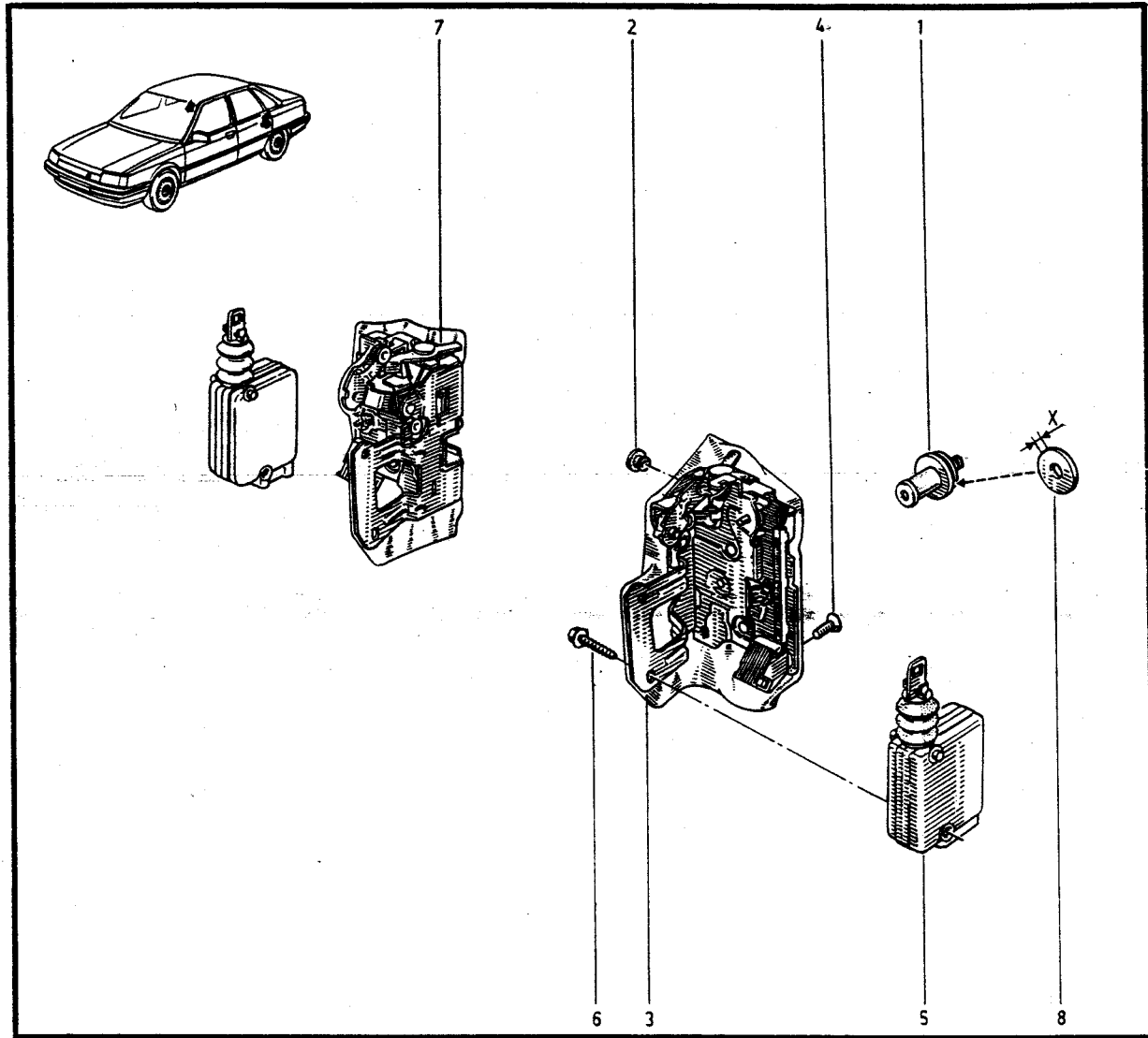

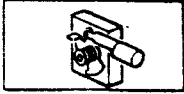

50.27
P.R. 1233

- 1-77 00 768 825
- 2-77 03 072 050
- 3-77 00 712 901
- 4-77 03 017 002
- 5-77 00 767 837
- 6-77 00 767 838
- 7-77 00 767 836
- 8-77 01 030 059

50.27
P.R. 1233

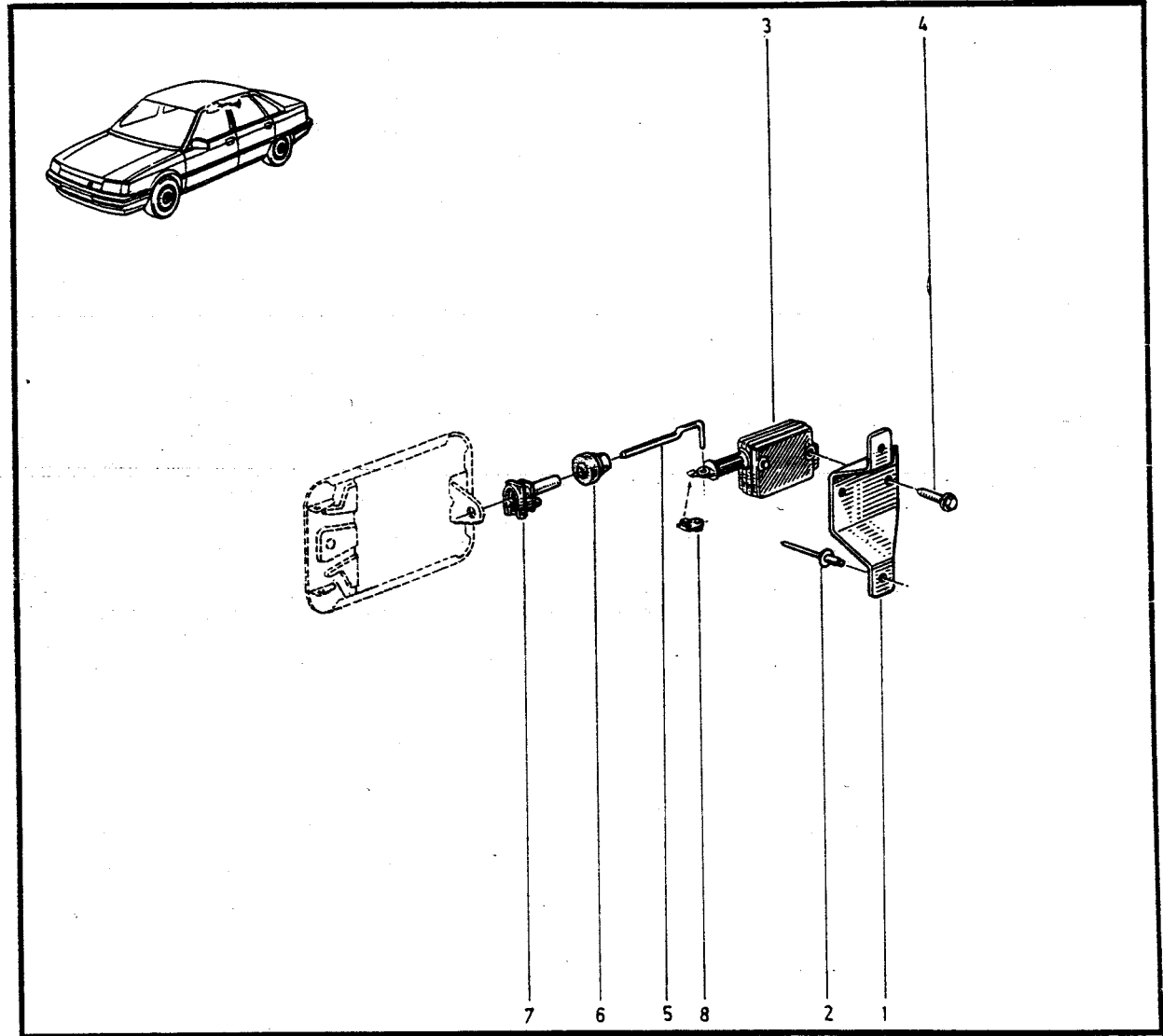



50.30
P.R. 1233

- 1- 77 00 767 632
- 2- 77 03 001 118
- 3- 77 03 056 083
- 4- 77 00 771 309
- 5- 77 00 767 633
- 6- 77 00 767 635
- 7- 77 00 767 636

50.30
P.R. 1233

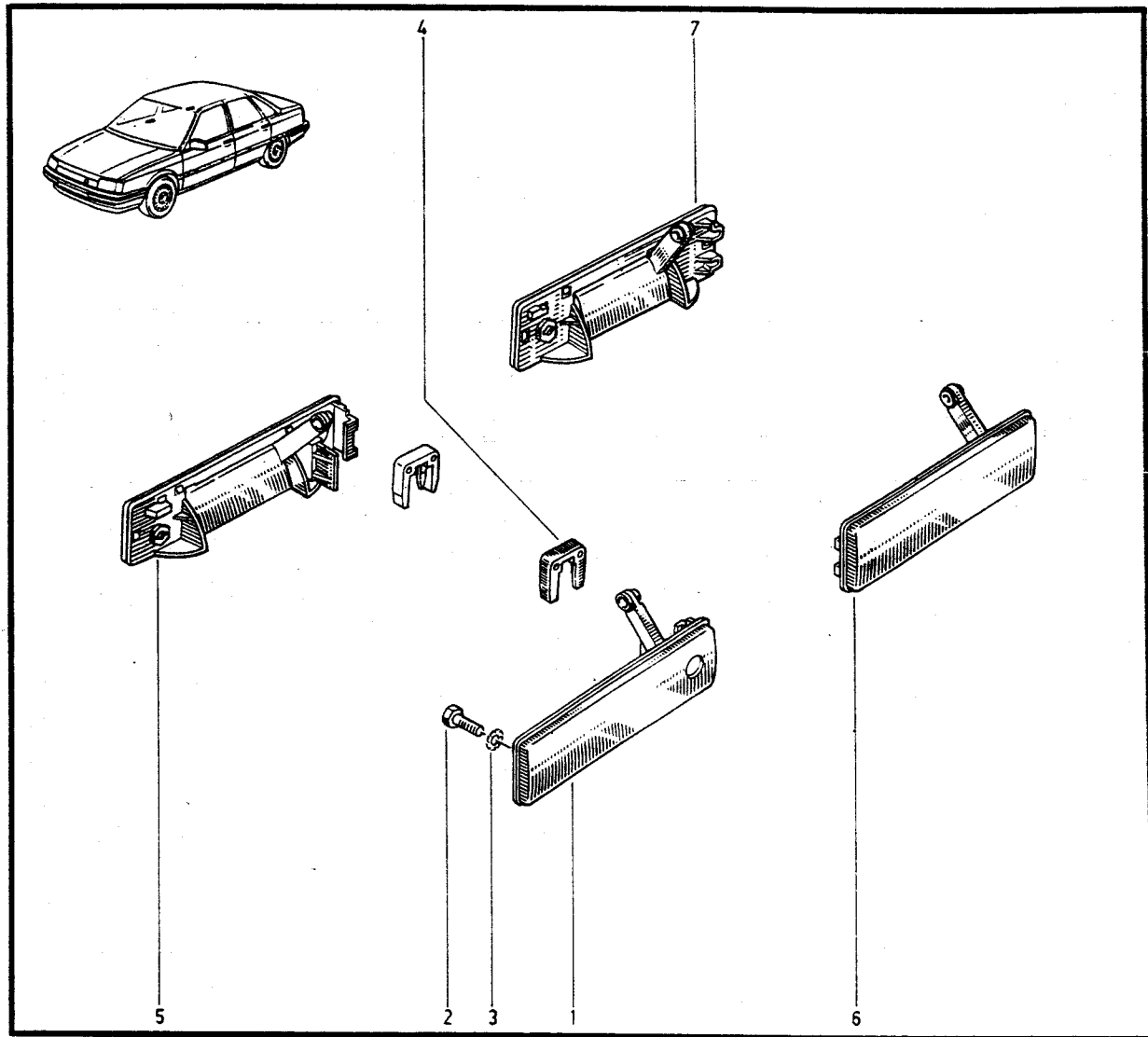



50.40

P.R. 1233

50.40

P.R. 1233



- 1- 77 00 768 903
- 2- 77 03 072 050
- 3- 77 00 797 424 [2]
- 4- 77 03 006 133
- 5- 77 03 053 032
- 6- 77 00 767 766
- 7- 77 00 765 276
- 8- 77 00 765 278
- 9- 77 00 763 215
- 10- 77 00 805 480 [2]
- 11- 77 00 768 904
- 12- 77 00 797 425 [2]
- 13- 77 00 767 767
- 14- 77 00 765 277
- 15- 77 00 765 279
- 16- 77 00 763 216

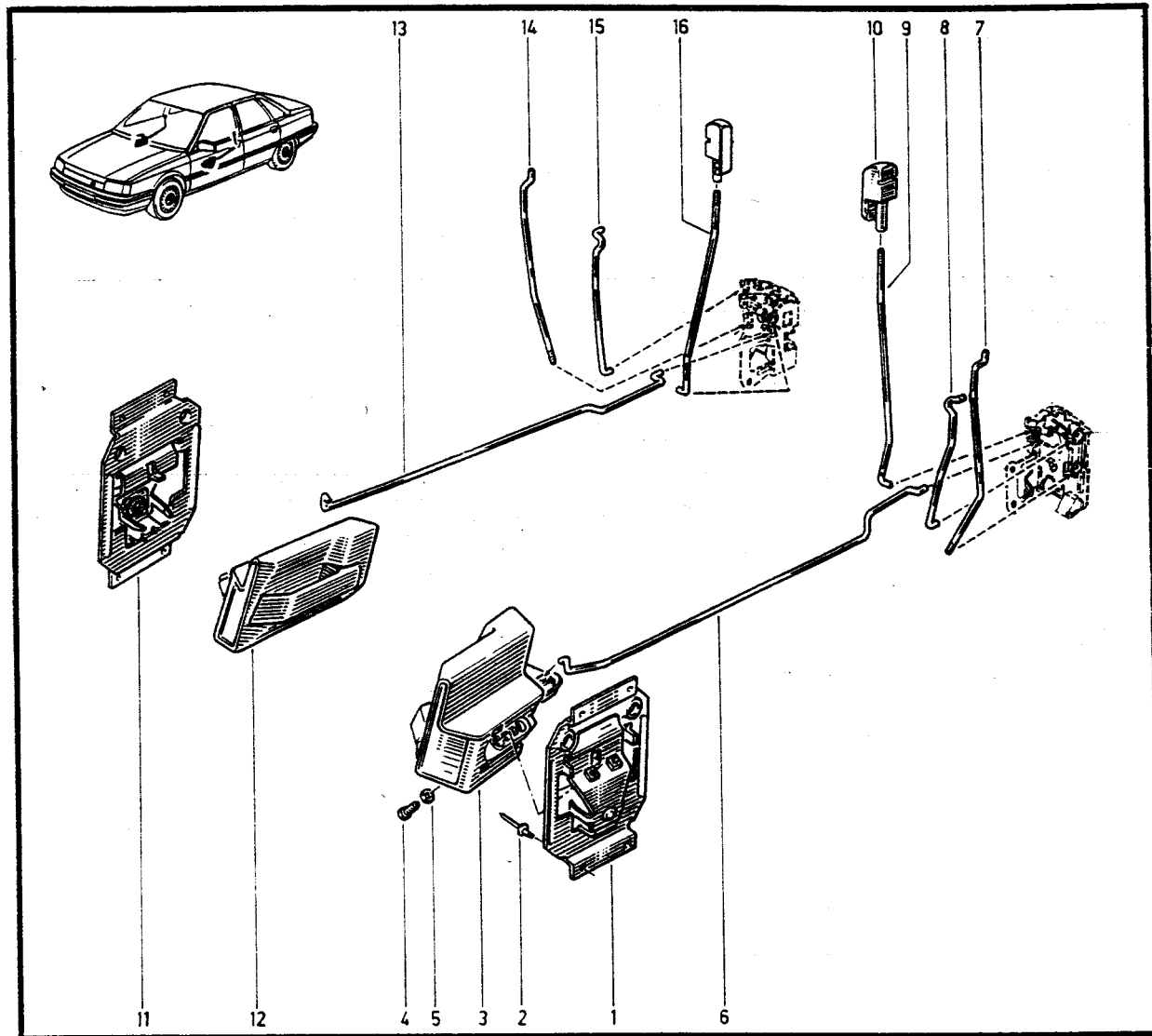



50.50

P.R. 1233

50.50

P.R. 1233



- 1- 77 00 768 903
- 2- 77 03 072 050
- 3- 77 00 797 424 (a)
- 4- 77 03 006 133
- 5- 77 03 053 032
- 6- 77 00 767 768 (a)
- 77 02 098 689 (b)
- 7- 77 03 079 027
- 8- 77 00 765 274
- 9- 77 02 098 363 (a)
- 77 02 098 555 (b)
- 10- 77 00 757 267
- 11- 77 00 805 480 (a)
- 12- 77 00 768 904
- 13- 77 00 797 425 (a)
- 14- 77 00 767 769 (a)
- 77 02 098 690 (b)
- 15- 77 02 098 364 (a)
- 77 02 098 554 (b)
- 16- 77 00 765 275

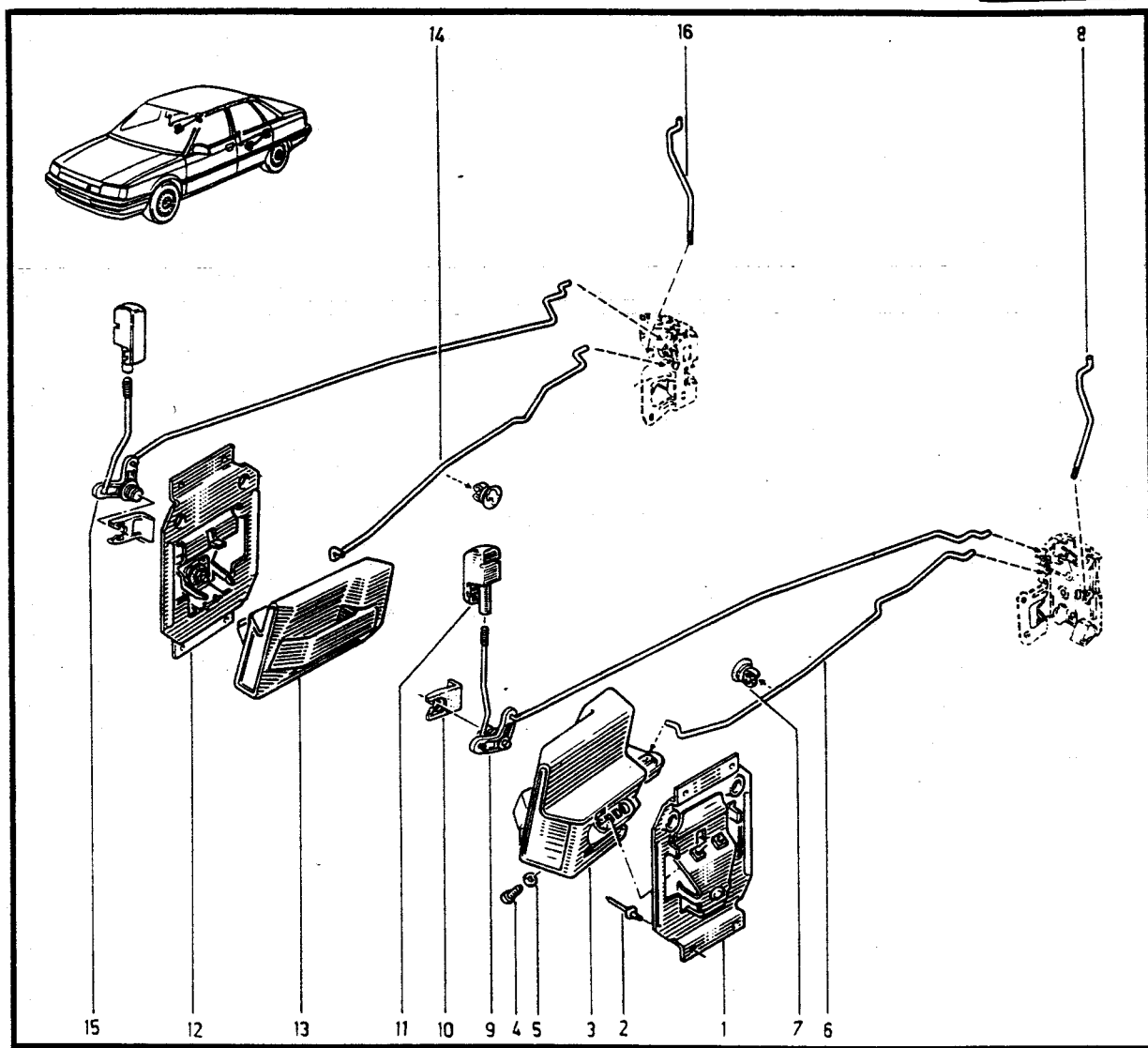



50.60

P.R. 1233

E

50.60

P.R. 1233



- 1- 77 00 767 814 †
- 77 02 098 348
- 2- 77 03 008 069
- 3- 77 03 035 015
- 4- 77 03 079 409
- 5- 77 00 767 815 †
- 77 02 098 349
- 6- 77 00 759 574
- 7- 77 00 781 877
- 8- 77 00 781 878

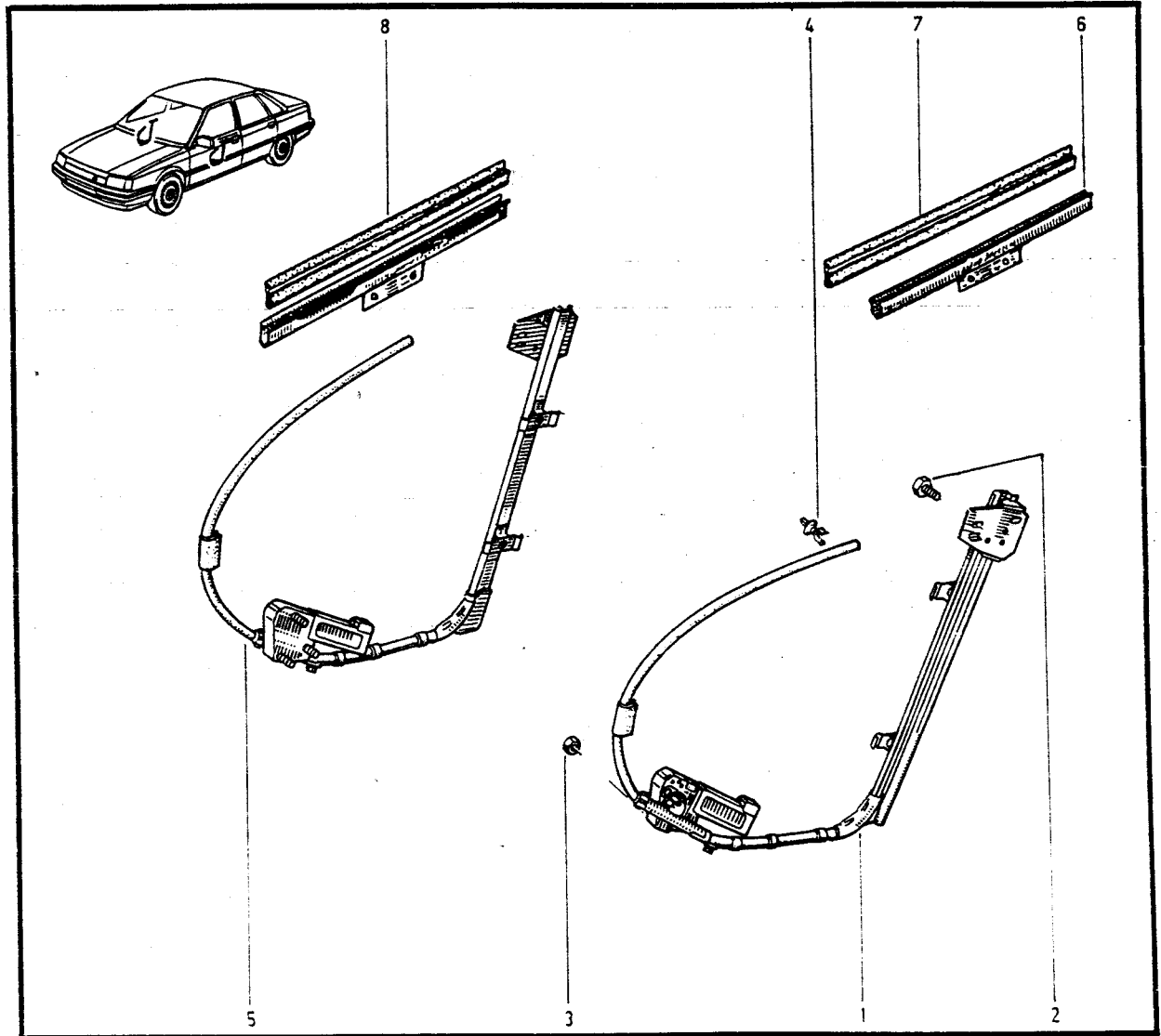



50.70

P.R. 1233

E

50.70

P.R. 1233



- 1 - 77 00 767 818
- 2 - 77 03 008 069
- 3 - 77 03 035 015
- 4 - 77 00 773 758
- 5 - 77 00 767 819
- 6 - 77 03 079 409
- 7 - 77 00 759 574
- 8 - 77 00 781 875 (a)
- 77 00 781 879 (b)
- 9 - 77 00 781 876 (a)
- 77 00 781 880 (b)

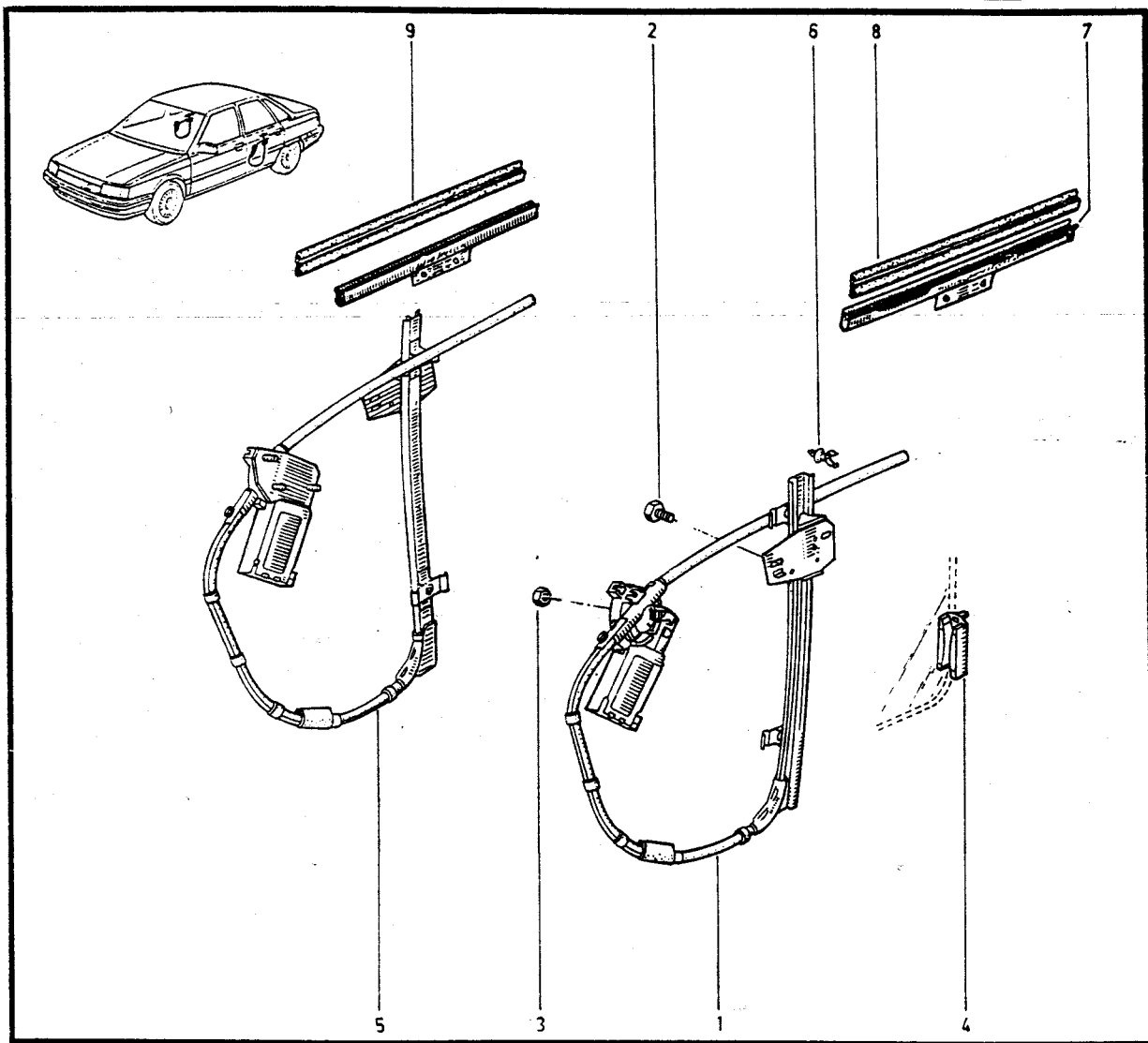

L48Z 091/095/096

L48S 090/091

L488 089

(a) L48X 208

L48G 202

L48K 209

L48Y 091

K48S 090/092

K48Y 090/092

(b) K48G 202

K488 089-K487

K48X 210

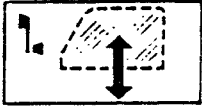

50 . 72
P.R. 1233

MI

50 . 72
P.R. 1233

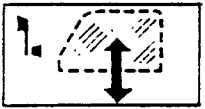

- 1- 77 00 767 816
- 2- 77 03 008 069
- 3- 77 03 079 409
- 4- 77 00 773 758
- 5- 77 00 767 817
- 6- 77 00 797 102 (a)
- 7- 77 00 781 876 (a)
- 77 00 781 880 (b)
- 8- 77 00 781 875 (a)
- 77 00 781 879 (b)
- 9- 77 00 759 574

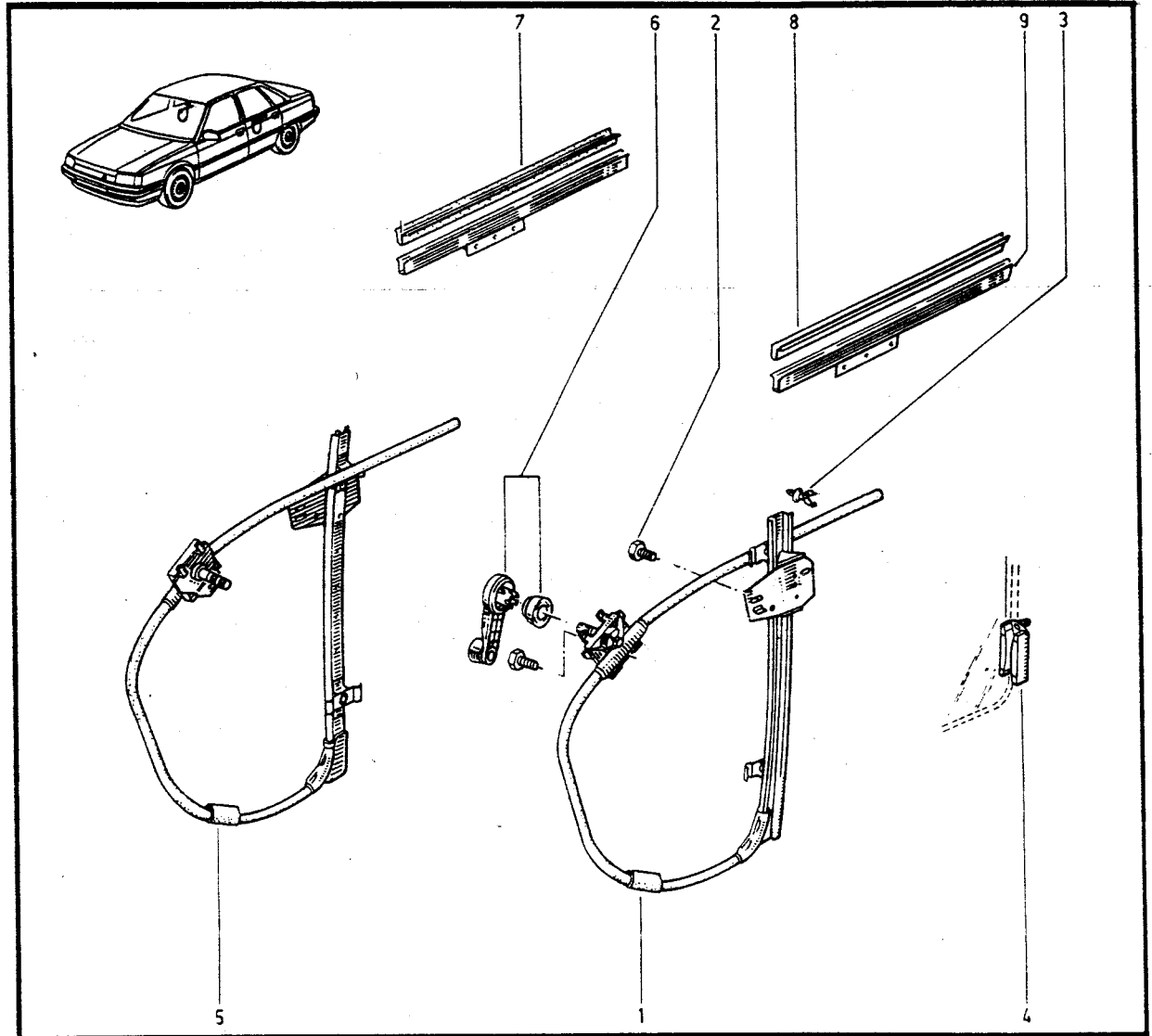

- (a) / L48G 202
- L488 089
- (b) / K48G 202
- K488 089-K487



52.01
P.R. 1233

- 1-77 00 766 409
- 2-77 03 044 102
- 3-77 03 001 241
- 4-77 03 056 083
- 5-77 00 761 466 +
- 6-77 03 001 865
- 7-77 00 767 823
- 8-77 00 761 461
- 9-79 03 032 009
- 10-77 03 079 389
- 11-79 03 056 014

52.01
P.R. 1233

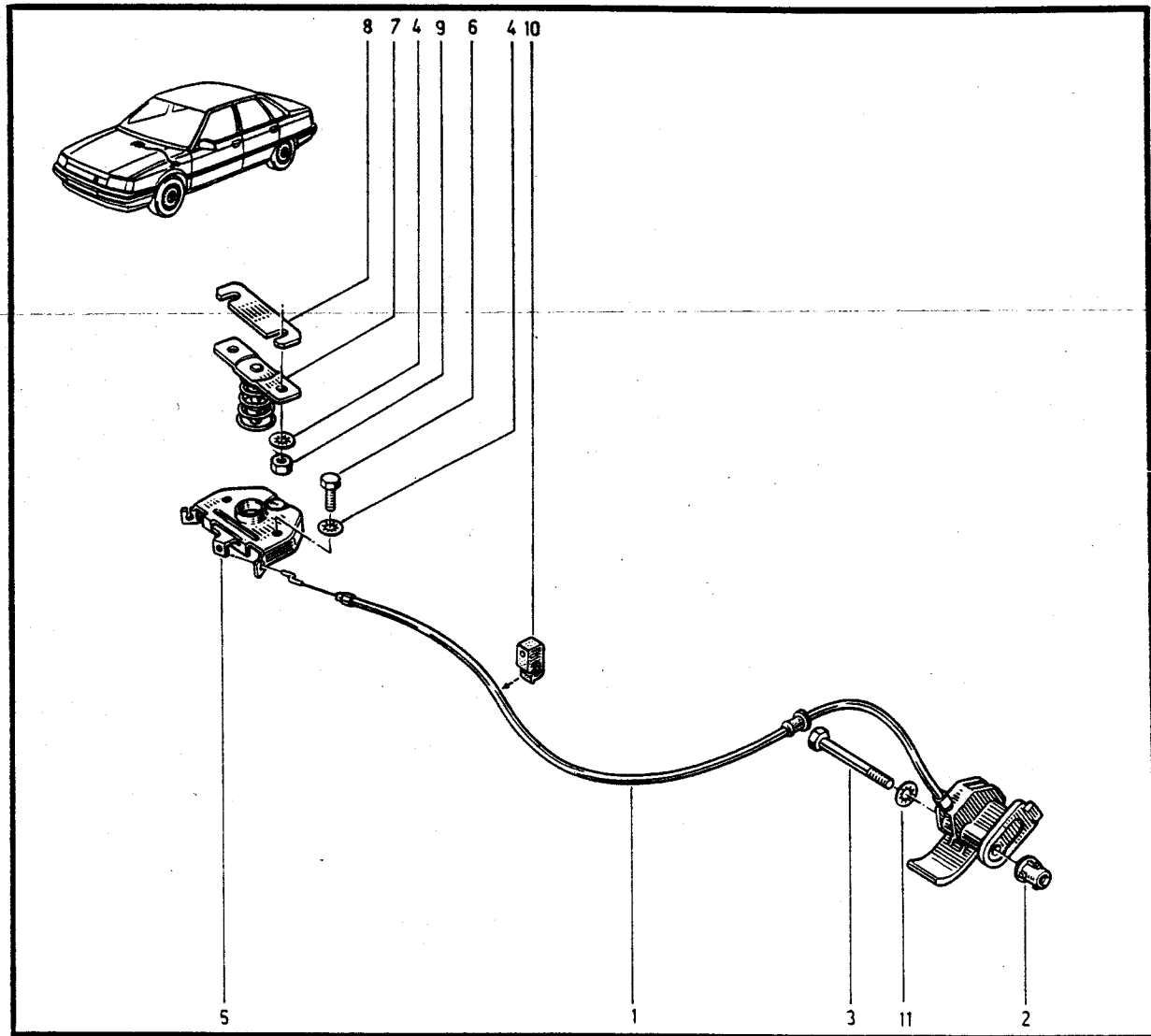



52.20.1

P.R. 1233

52.20.1

P.R. 1233



- 1 - 77 00 785 587
- 2 - 79 03 056 014
- 3 - 77 00 781 702
- 4 - 77 00 771 371
- 5 - 77 03 001 123
- 6 - 77 03 056 083
- 7 - 77 02 098 660
- 8 - 77 01 033 789
- 9 - 77 01 032 911
- 10 - 77 03 066 153
- 11 - 77 00 771 167
- 12 - 77 00 712 901 ←
- 13 - 77 03 017 002 ←
- 14 - 77 00 771 166 ←
- 15 - 77 01 030 059 ←
- 16 - 77 01 031 090
- 17 - 77 00 780 722

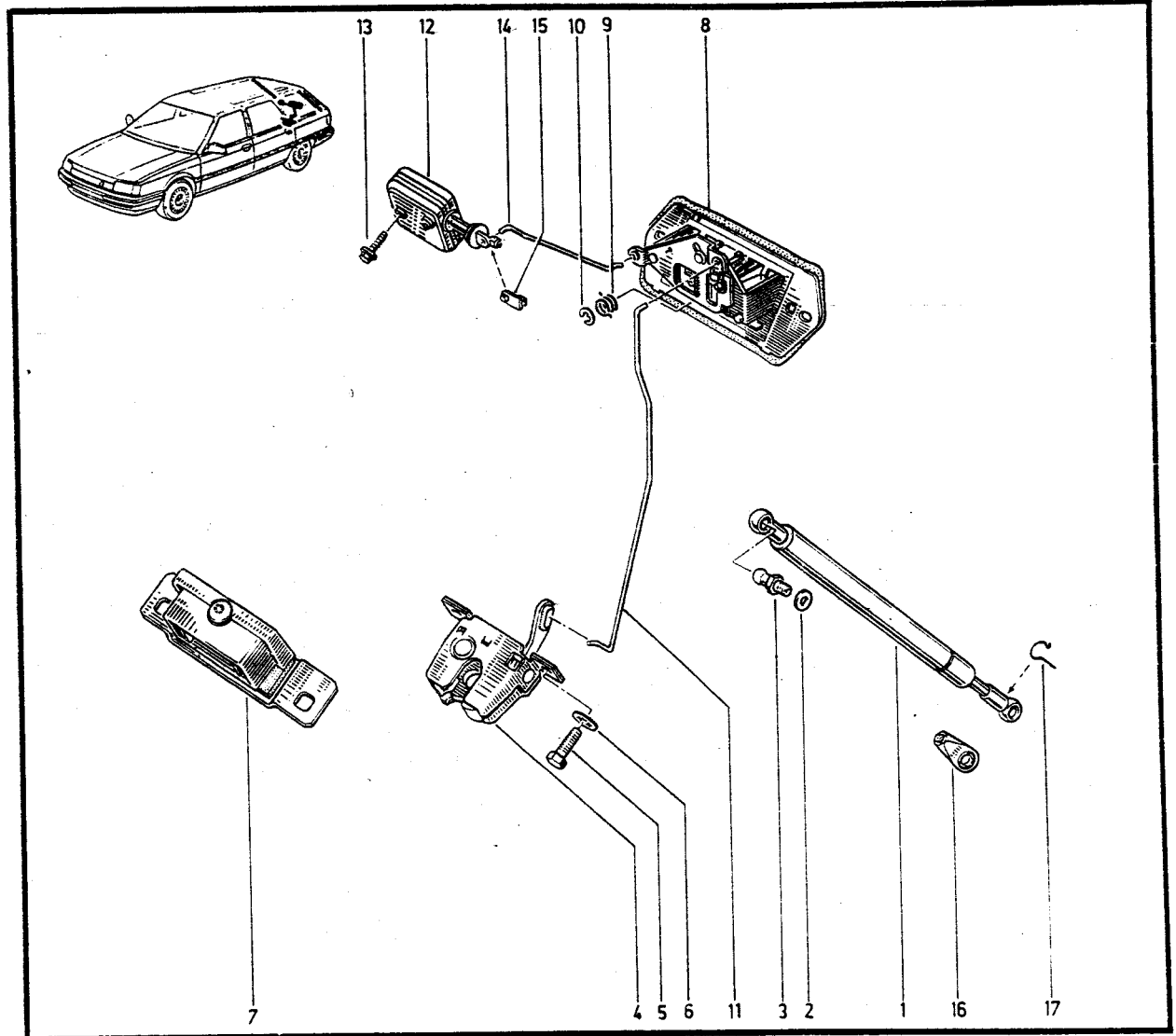



52.21.1
P.R. 1233

52.21.1
P.R. 1233



- 1- 77 00 795 730 (a)
- 77 00 802 094 (b)
- 2- 77 00 807 703
- 3- 77 03 001 123
- 4- 77 03 056 083
- 5- 77 00 816 409
- 6- 77 00 788 764
- 7- 77 00 712 901 ←
- 8- 77 00 785 204 ←
- 9- 77 01 030 059 ←
- 10- 77 03 017 002 ←
- 11- 77 00 794 982 ←
- 12- 77 01 035 372 ←

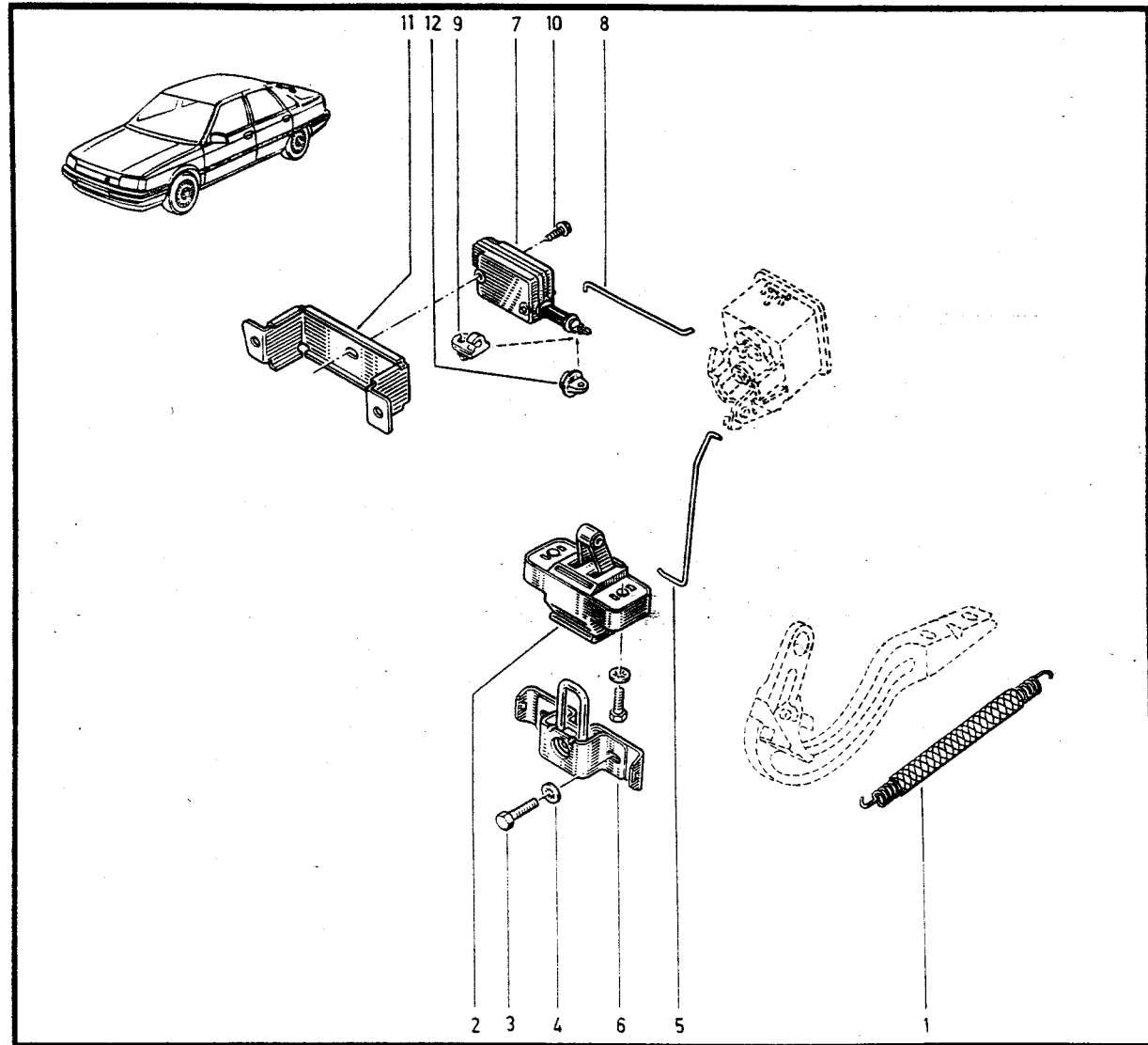

- | |
|------------------|
| L48S 090/091 |
| (a) L48G 202 |
| L48X 208 |
| L488 089 |
| L48Z 091/095/096 |
| (b) L48Y 091/090 |
| L48K 209 |

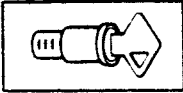

53.01

P.R. 1233

- 1- 77 01 202 568 (a)
- 77 01 203 953 (c)
- 2- 77 00 767 675
- 3- 77 01 349 791
- 4- 77 01 349 790
- 5- 77 01 032 412
- 6- 77 01 032 244
- 7- 77 00 859 167 (b)†
- 77 00 900 574 (b)
- 8- 77 00 703 348 (b)
- 9- 77 00 803 941 (b)

53.01

P.R. 1233

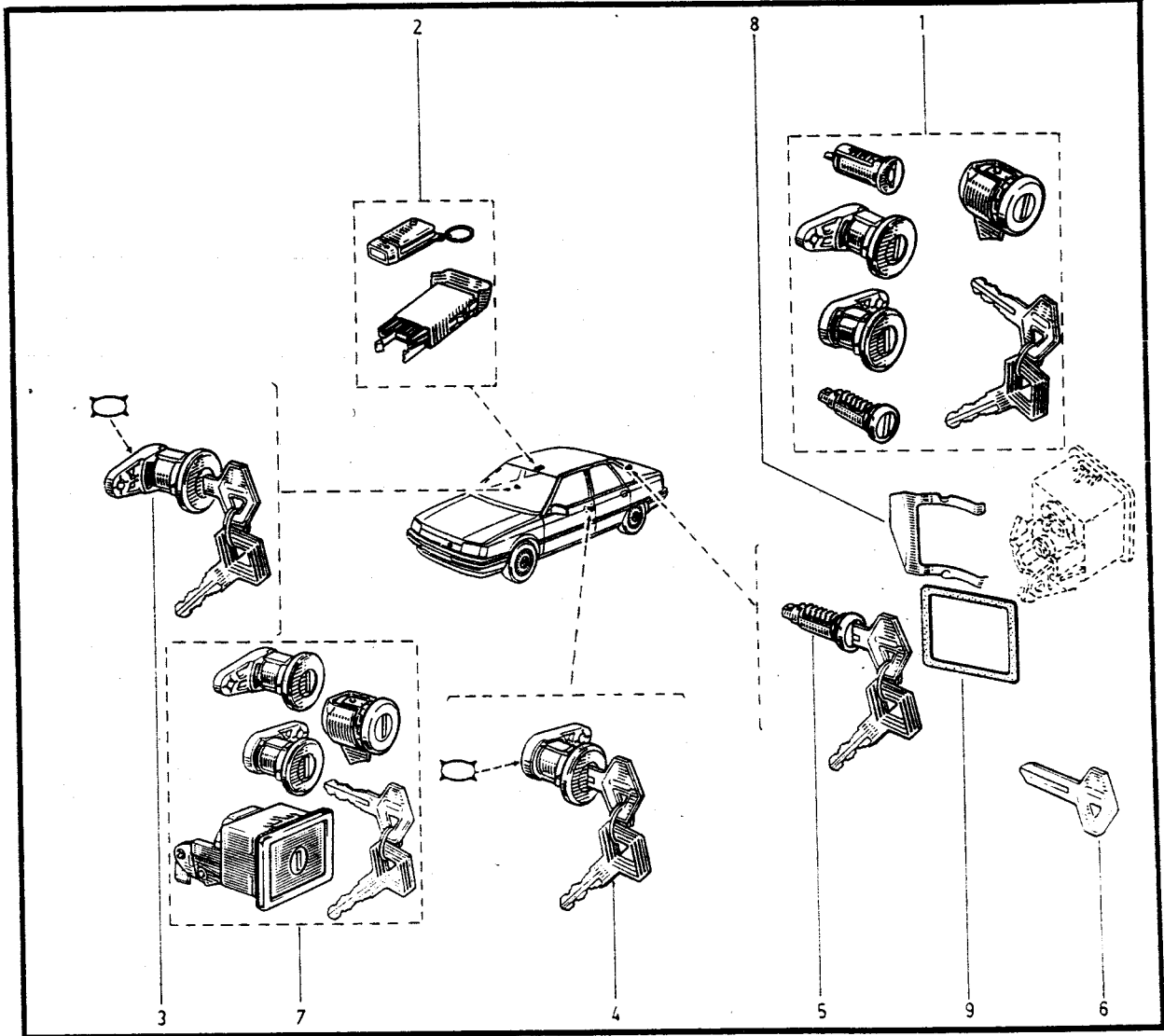
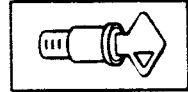

- L48S 090/091
- L48Z 091/095/096
- L48X 208
- (a) L48Y 091/090
- L488 089
- L48K 209
- L48G 202

- K48S 090/092
- K48Y 090/092
- (b) K488 089-K487
- K48X 210
- K48G 202

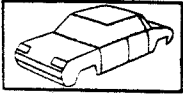

54.01

P.R. 1233

- 1- 77 02 206 973
- 2- 77 01 211 435
- 3- 77 02 206 196
- 4- 77 02 211 469
- 5- 77 02 211 471
- 6- 77 02 211 477
- 7- 77 02 211 470
- 8- 77 02 211 472
- 9- 77 02 211 478
- 10- 02 25 191 100
- 11- 77 03 076 188
- 12- 77 03 072 252

54.01

P.R. 1233

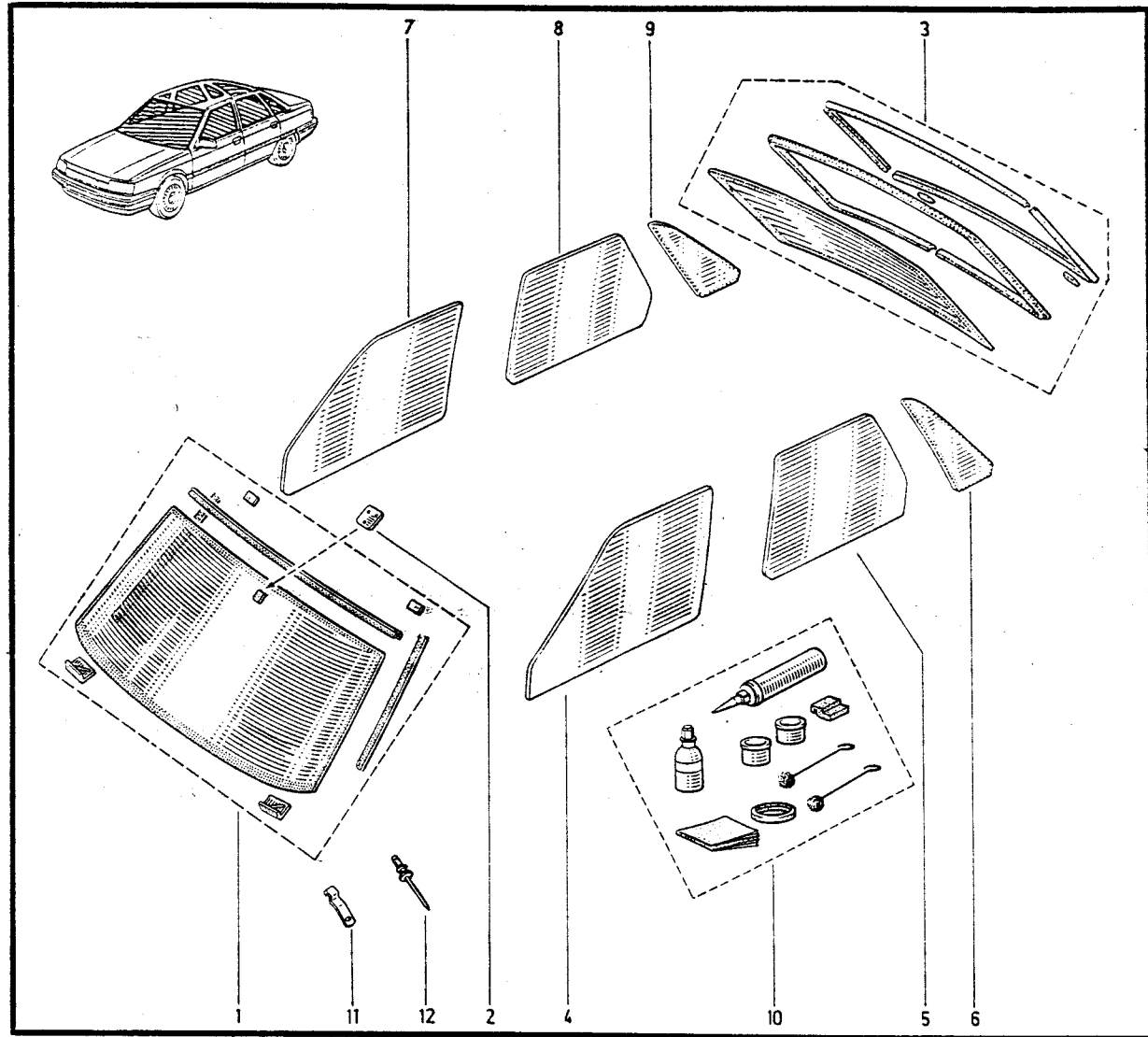
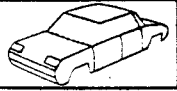

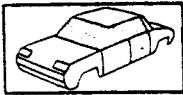

54.01.1

P.R. 1233

- 1- 77 02 206 973
- 2- 77 02 211 435
- 3- 77 02 211 469
- 4- 77 00 766 214
- 77 02 211 490
- 5- 77 02 206 229
- 6- 77 02 211 470
- 7- 77 02 211 491
- 8- 77 02 206 230
- 9- 77 02 213 946
- 10- 02 25 191 100
- 11- 77 03 076 188
- 12- 77 03 072 252

54.01.1

P.R. 1233

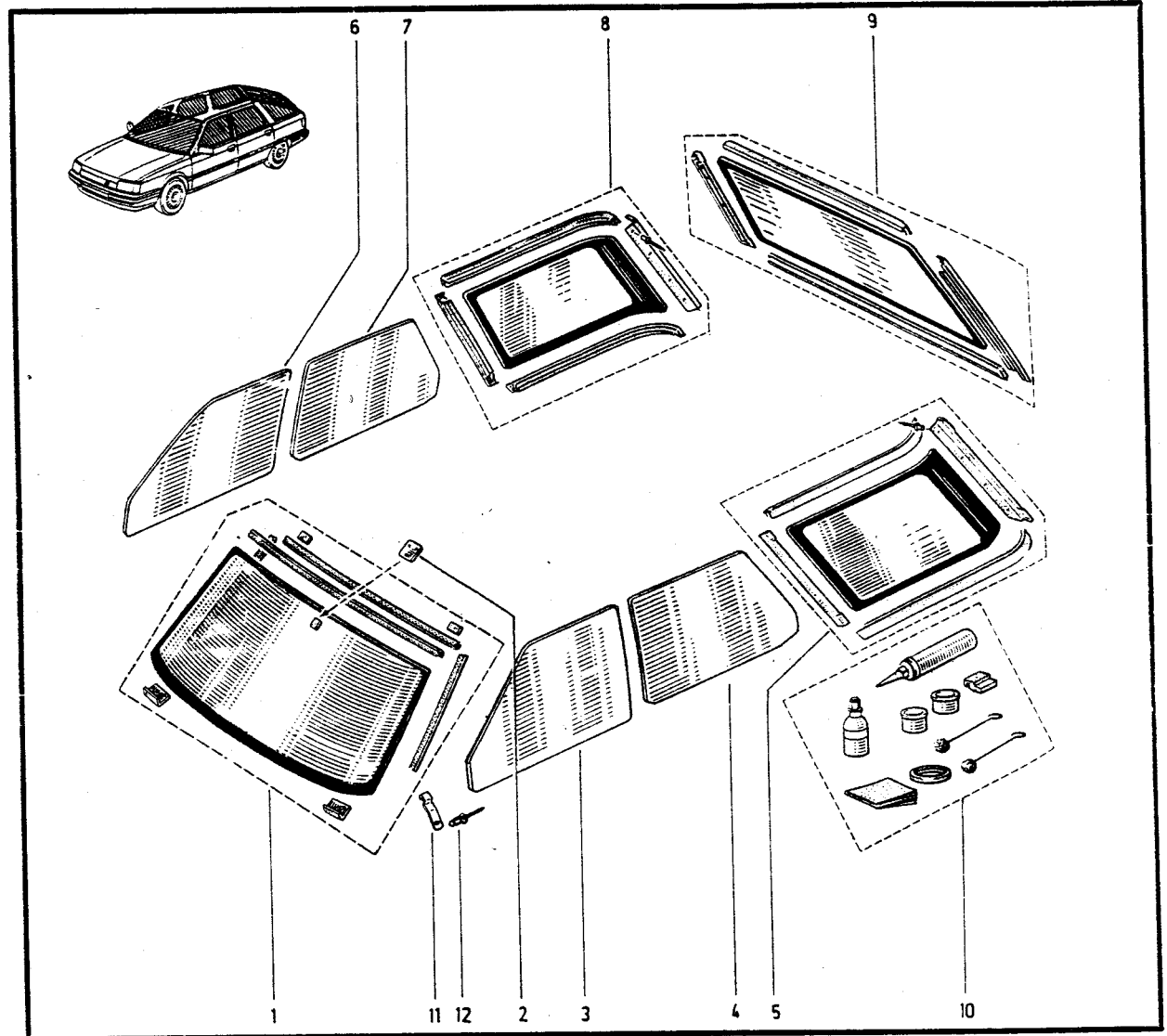
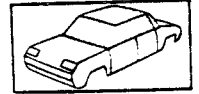

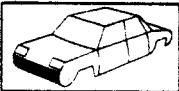

55.01.1

P.R. 1233

55.01.1

P.R. 1233

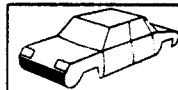

- 1- 77 00 900 451 → (a)
- 77 00 900 526 → (b)
- 77 02 219 427 (c)
- 2- 77 00 789 562 (a)(b)
- 77 00 800 510 (c)
- 3- 77 00 789 896
- 4- 77 03 046 020
- 5- 77 03 001 167
- 6- 77 00 789 897
- 7- 77 03 077 135
- 8- 77 00 790 117
- 9- 77 00 789 894
- 10- 77 01 465 617
- 11- 77 00 900 452 → (a)(b)
- 77 00 802 654 (c)
- 12- 77 02 214 333

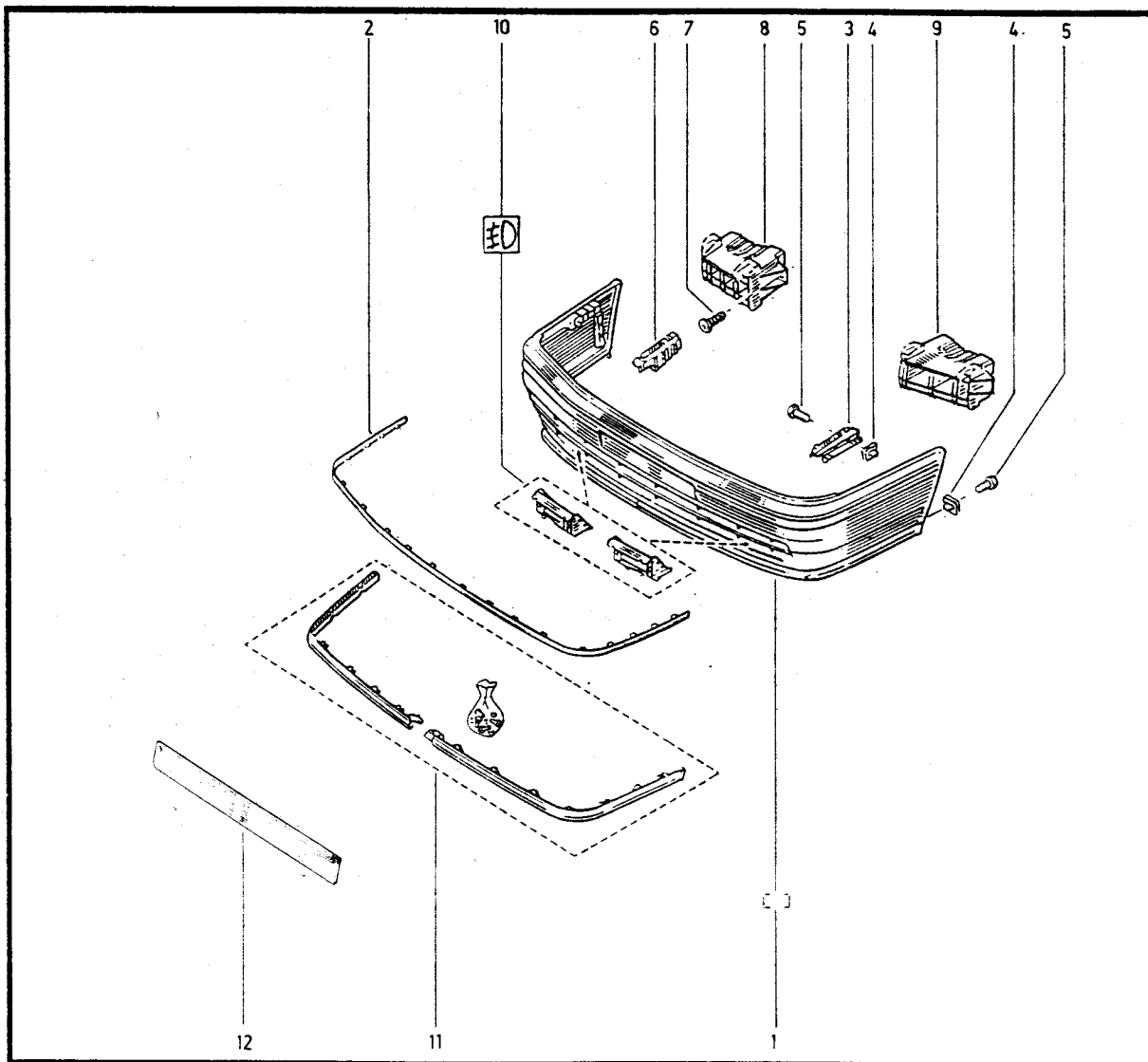

- L48G 202
- (a) L488 089
- K48G 202
- K488 089
- (c) K487 089

- L48Z 091/095/096
- L48S 090/091
- (b) L48X 208 K48X 210
- K48S 090/092
- K48Y 090/092
- L48Y 091

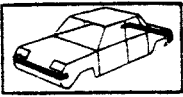

55.10.2

P.R. 1233

55.10.2

P.R. 1233

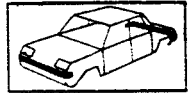

- 1- 77 00 900 454 ➡+
- 77 02 217 521 ➡-
- 2- 77 00 793 371
- 3- 77 00 790 924
- 4- 77 03 015 115
- 5- 77 03 034 008
- 6- 77 03 046 020
- 7- 77 03 056 085
- 8- 77 03 001 162
- 9- 77 00 790 925
- 10- 77 03 046 048
- 11- 77 03 053 032
- 12- 77 03 001 904

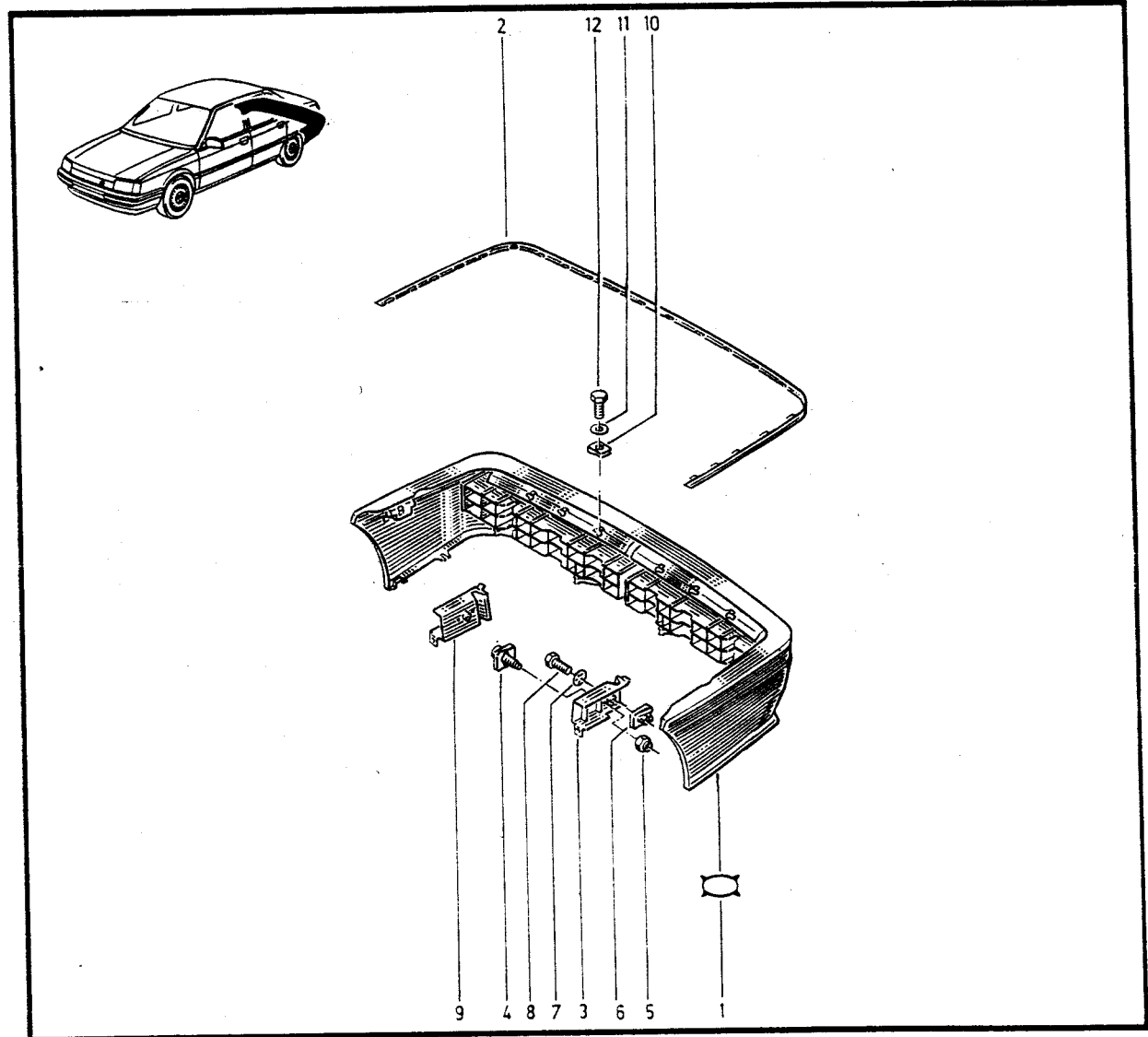

- L488 089
- L48Z 091/095/096
- L48S 090/091
- L48G 202
- L48X 208
- L48Y 091

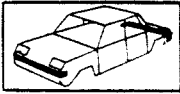

55.10.3

P.R. 1233

- 1 - 77 00 900 453 (a)
- 77 00 790 335 (b)
- 2 - 77 00 793 368
- 3 - 77 00 793 369
- 4 - 77 00 791 103
- 5 - 77 03 015 115
- 6 - 77 03 034 008
- 7 - 77 03 046 020
- 9 - 77 03 056 085
- 9 - 77 03 001 162
- 10 - 77 00 791 104
- 11 - 77 03 006 104
- 12 - 77 03 044 102
- 13 - 77 00 805 742
- 14 - 77 03 072 230
- 15 - 77 03 016 407
- 16 - 77 03 046 082
- 17 - 77 00 805 743

55.10.3

P.R. 1233

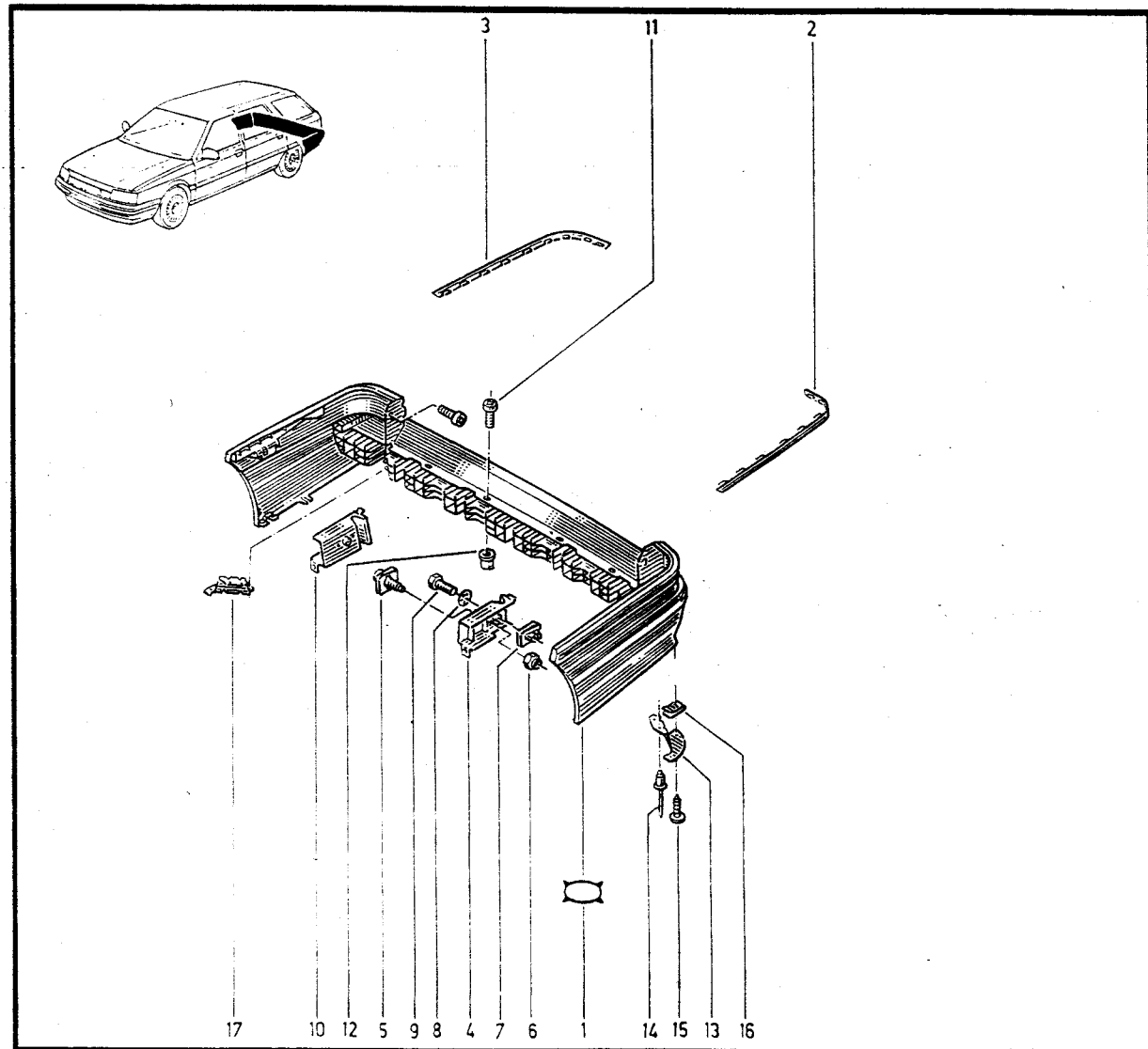
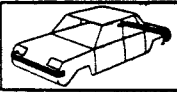

- (a) / K48S 090/092
- / K48Y 090/092
- / K48G 202
- / K48X 210
- / K488 089

(b) / K487 089

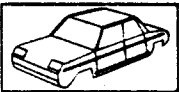

55.20

P.R. 1233



55.20

P.R. 1233

- 1- 77 00 827 694
- 2- 77 03 072 172
- 3- 77 00 817 696
- 4- 77 03 016 518
- 5- 77 00 827 700
- 6- 77 00 787 979
- 7- 77 03 072 276
- 8- 77 00 827 704
- 9- 77 00 827 695
- 10- 77 00 827 697
- 11- 77 00 827 701
- 12- 77 00 827 705
- 13- 77 00 772 190
- 14- 77 03 016 287
- 15- 77 03 077 006
- 16- 77 00 772 191
- 17- 77 00 795 309 [5]
- 18- 77 00 795 310 [3]

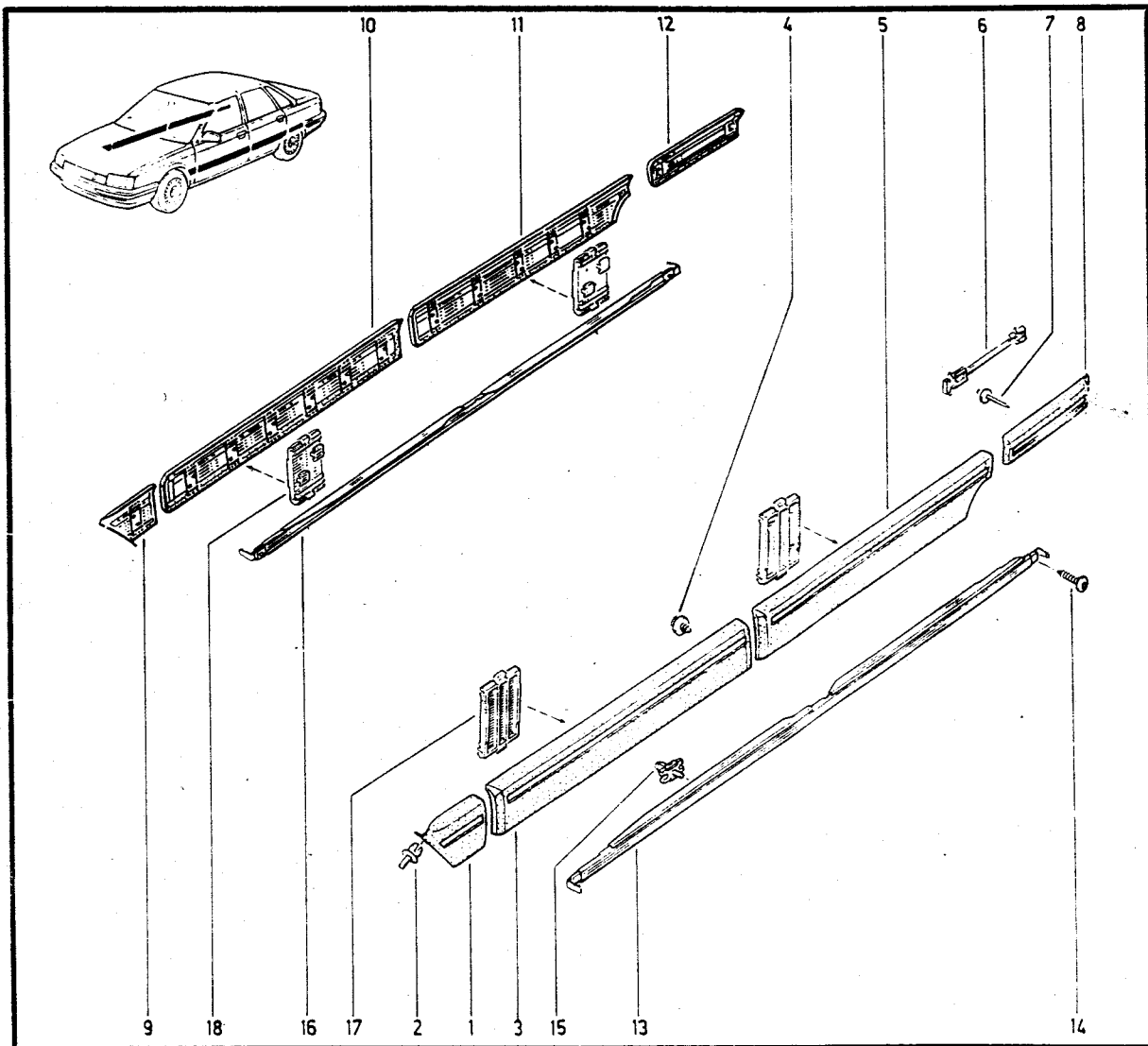

L48S	⇄	n ²	12397	⇄	n ²
L48Z	⇄	n ²	4	⇄	n ²
L488	⇄	n ²	355	⇄	n ²
L48K	⇄	n ²	5	⇄	n ²
L48G	⇄	n ²	1	⇄	n ²
L48X	⇄	n ²	1	⇄	n ²
L48Y	⇄	n ²	1	⇄	n ²

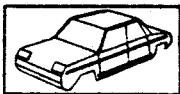

55.22

P.R. 1233

55.22

P.R. 1233

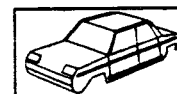

- 1-77 00 827 694
- 2-77 03 072 172
- 3-77 00 827 696
- 4-77 03 016 518
- 5-77 00 827 702
- 6-77 00 787 977
- 7-77 03 072 276
- 8-77 00 827 706
- 9-77 00 827 695
- 10-77 00 827 697
- 11-77 00 827 703
- 12-77 00 827 707
- 13-77 00 772 186
- 14-77 03 016 287
- 15-77 03 077 006
- 16-77 00 772 187
- 17-77 00 775 416
- 18-77 03 076 183
- 19-77 00 770 347
- 20-77 00 777 614
- 21-77 00 777 613
- 22-77 00 806 968
- 23-77 00 771 970
- 24-77 00 806 969
- 25-77 00 794 727
- 26-77 03 061 048
- 27-77 03 033 027
- 28-77 01 034 097
- 29-77 00 795 309 [5]
- 30-77 00 795 310 [3]

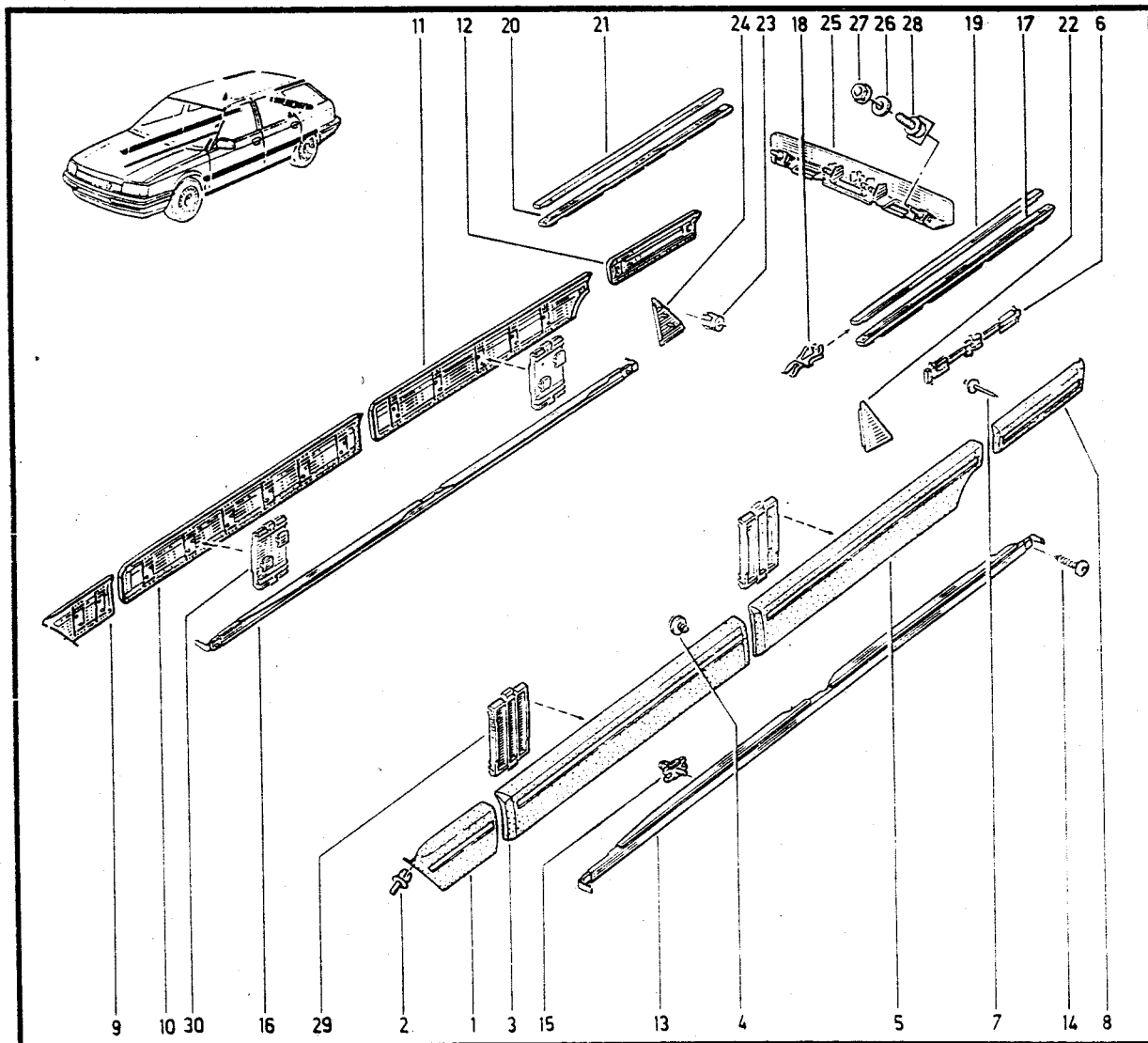

K48S		n ²	01707		n ²
K488		n ²	00002		n ²
K48G		n ²	1		n ²
K48Y		n ²	1		n ²
K48X		n ²	1		n ²

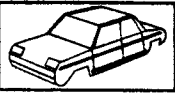

55.22.1

P.R. 1233

- 1-77 00 789 207
- 2-77 03 072 172
- 3-77 00 789 213
- 4-77 03 016 518
- 5-77 00 789 225
- 6-77 00 787 977
- 7-77 03 072 276
- 8-77 00 789 237
- 9-77 00 789 208
- 10-77 00 789 214
- 11-77 00 789 226
- 12-77 00 789 238
- 13-77 00 772 186
- 14-77 03 016 287
- 15-77 03 077 006
- 16-77 00 772 187
- 17-77 00 775 416
- 18-77 03 076 183
- 19-77 00 770 347
- 20-77 00 777 614
- 21-77 00 777 613
- 22-77 00 806 968
- 23-77 00 771 970
- 24-77 00 806 969
- 25-77 00 794 727
- 26-77 03 061 048
- 27-77 03 033 027
- 28-77 01 034 097
- 29-77 00 795 309 [5]
- 30-77 00 795 310 [3]

55.22.1

P.R. 1233

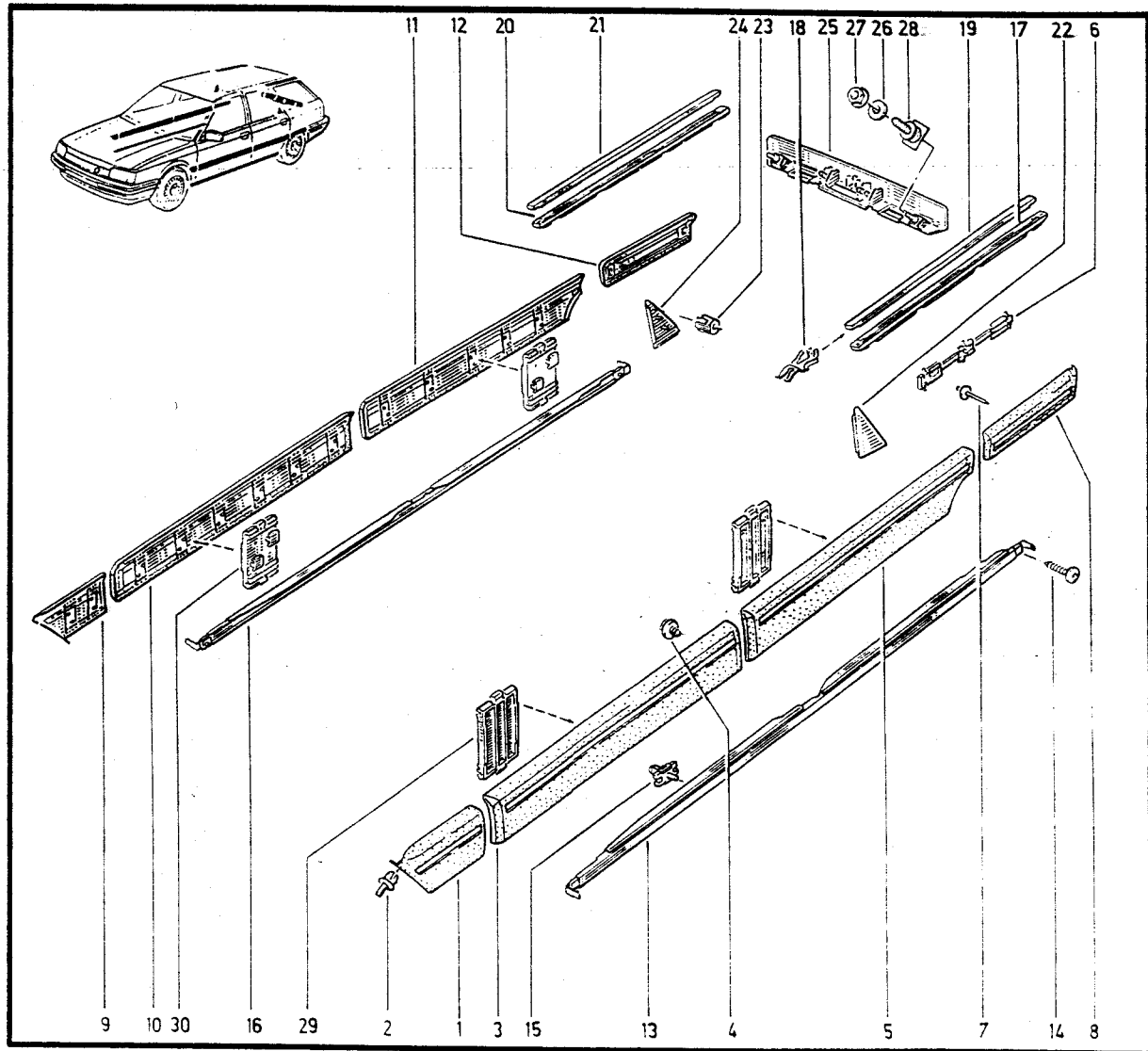
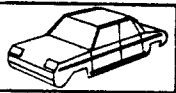

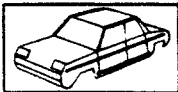

55.23

P.R. 1233

55.23

P.R. 1233

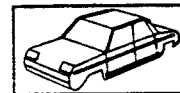

- 1- 77 01 465 626 † →
- 77 00 900 489 →
- 2- 77 03 077 238
- 3- 77 05 035 169
- 4- 77 03 080 049
- 5- 77 01 464 846
- 6- 77 00 790 734
- 7- 77 03 033 027
- 8- 77 03 061 048
- 9- 77 01 464 845

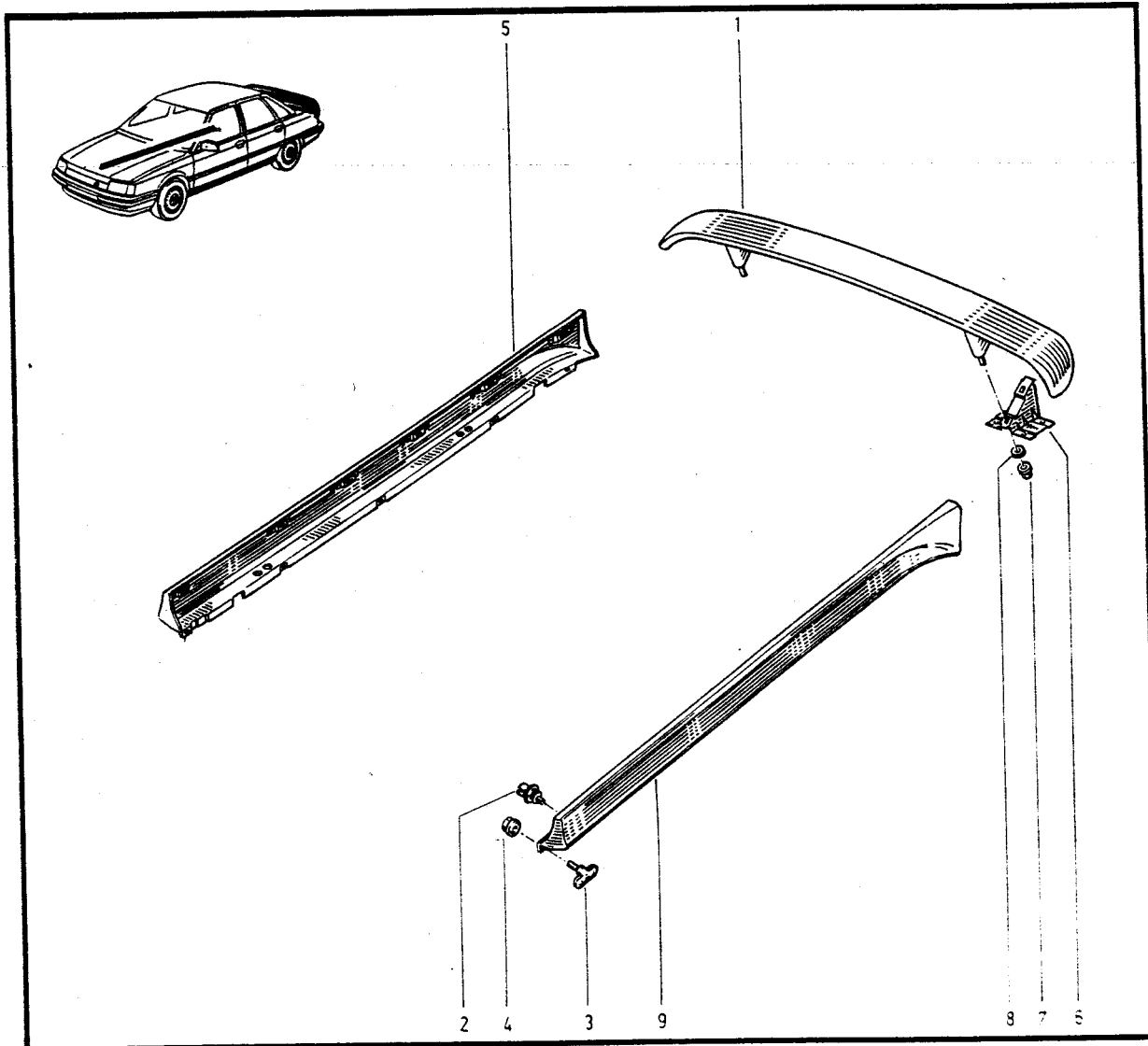

L48K	↔	n ²	1	⇨	n ²
L48Z	↔	n ²	1	⇨	n ²



55.25

P.R. 1233

- 1- 77 02 098 828
- 2- 77 03 081 026
- 77 03 081 086
- 3- 77 03 016 340
- 4- 77 00 764 366
- 5- 77 03 076 171
- 6- 77 00 764 367
- 7- 77 00 799 581
- 8- 77 00 799 582
- 9- 77 00 766 155
- 10- 77 00 761 983
- 11- 77 00 766 156
- 12- 77 02 211 497
- 13- 77 03 008 084
- 14- 77 03 061 031
- 15- 77 03 081 081
- 16- 77 00 767 520

55.25

P.R. 1233

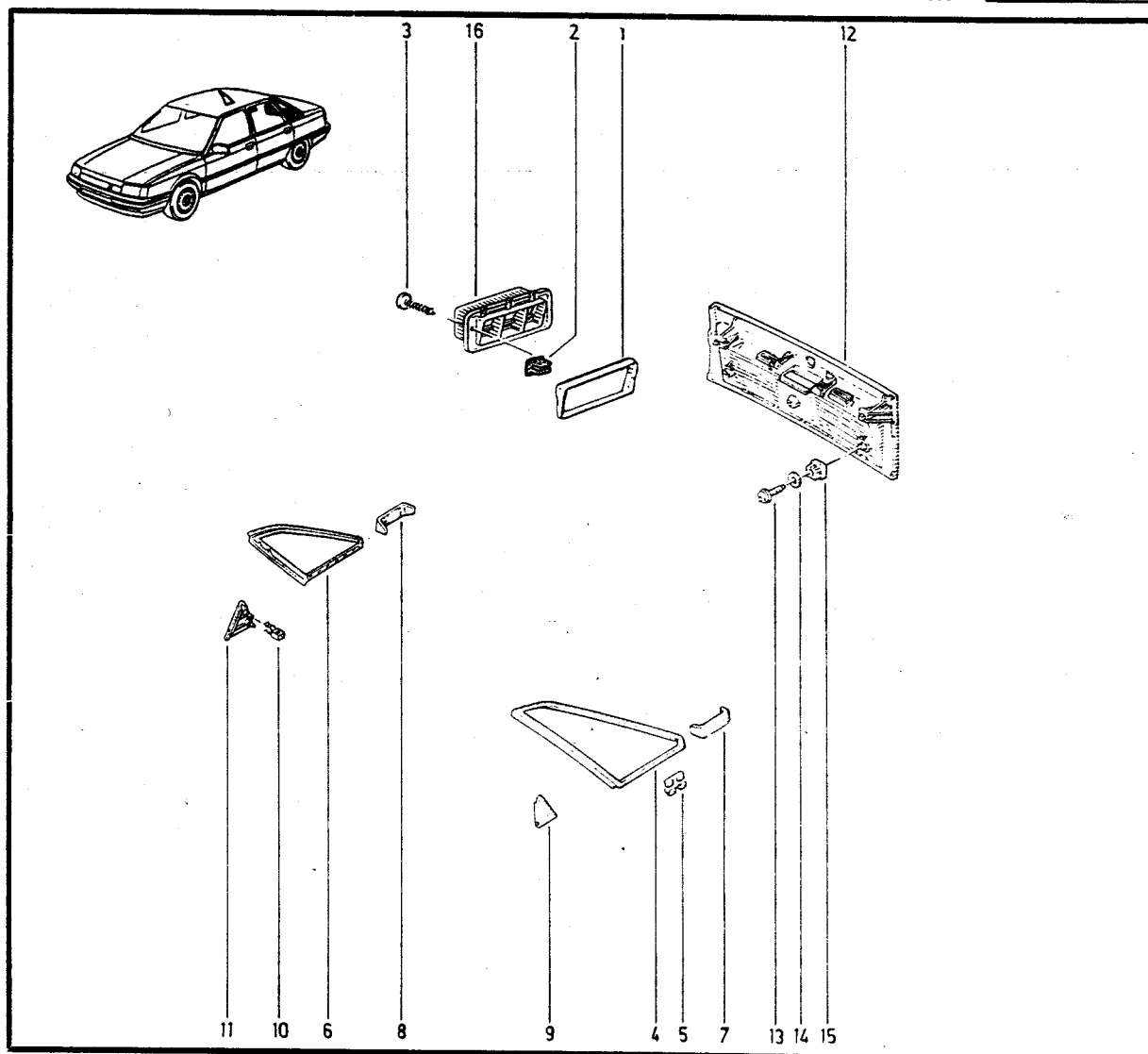
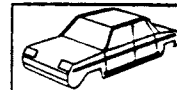



55.28

P.R. 1233

1- 77 03 034 008
2- 77 00 900 455 →
3- 77 00 793 372

55.28

P.R. 1233

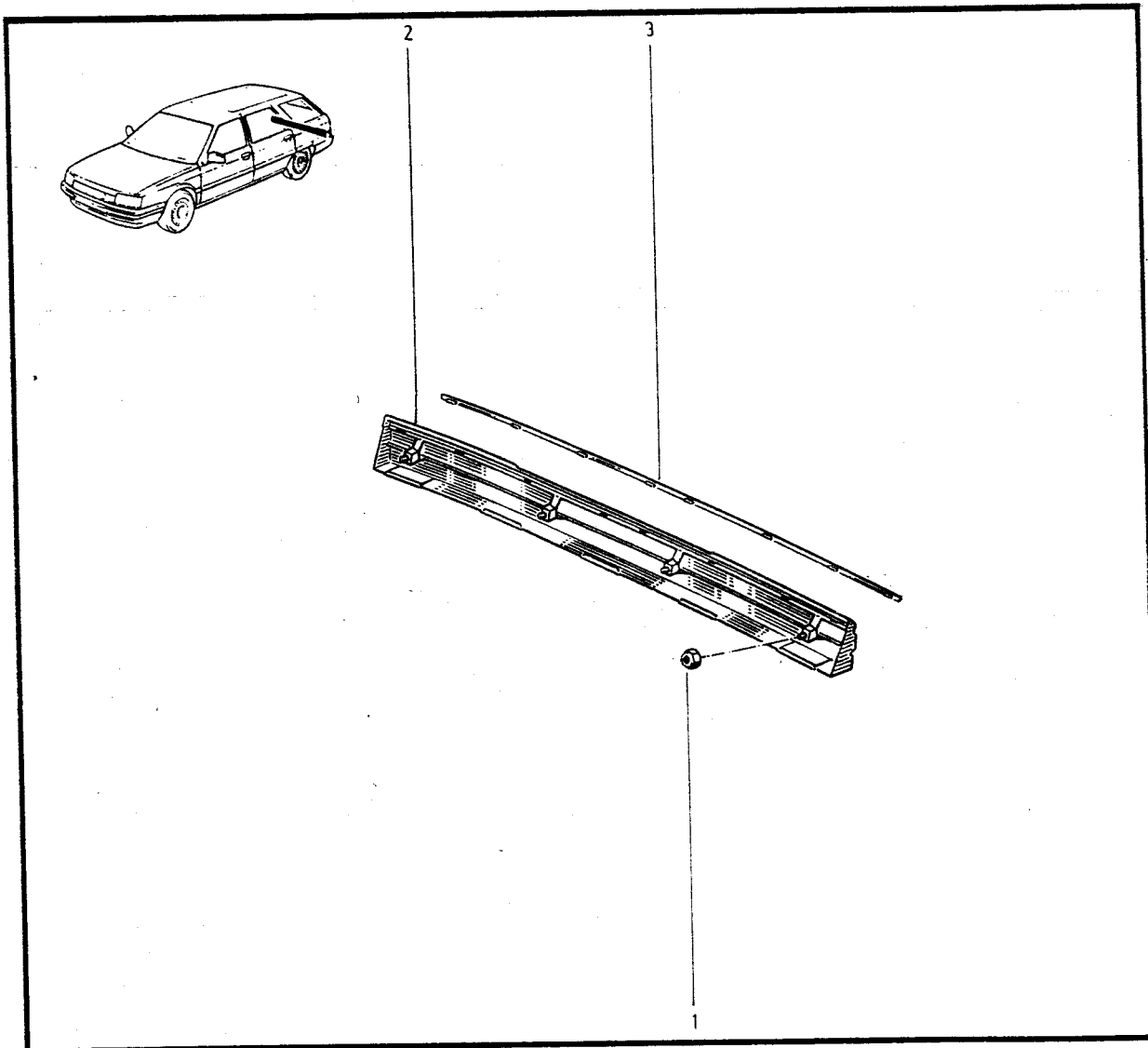

K48S	↔	n° 01003	↔	n°
K489	↔	n° 1	↔	n°
K488	↔	n° 1	↔	n°
K48G	↔	n° 1	↔	n°
K48X	↔	n° 1	↔	n°
K48Y	↔	n° 1	↔	n°

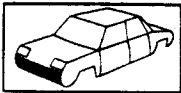

55.41.1

P.R. 1233

55.41.1

P.R. 1233

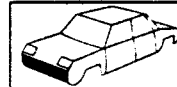

- 1- 77 01 034 276
- 2- 77 03 046 082
- 3- 77 00 016 285
- 4- 77 01 034 277
- 5- 77 03 016 401
- 6- 77 00 796 025
- 7- 77 03 072 239
- 8- 77 00 796 310
- 9- 77 01 034 278
- 10- 77 00 796 068
- 11- 77 00 796 462
- 12- 77 03 081 161
- 13- 77 00 825 976
- 14- 77 00 767 437
- 15- 77 03 081 019
- 16- 77 03 016 340

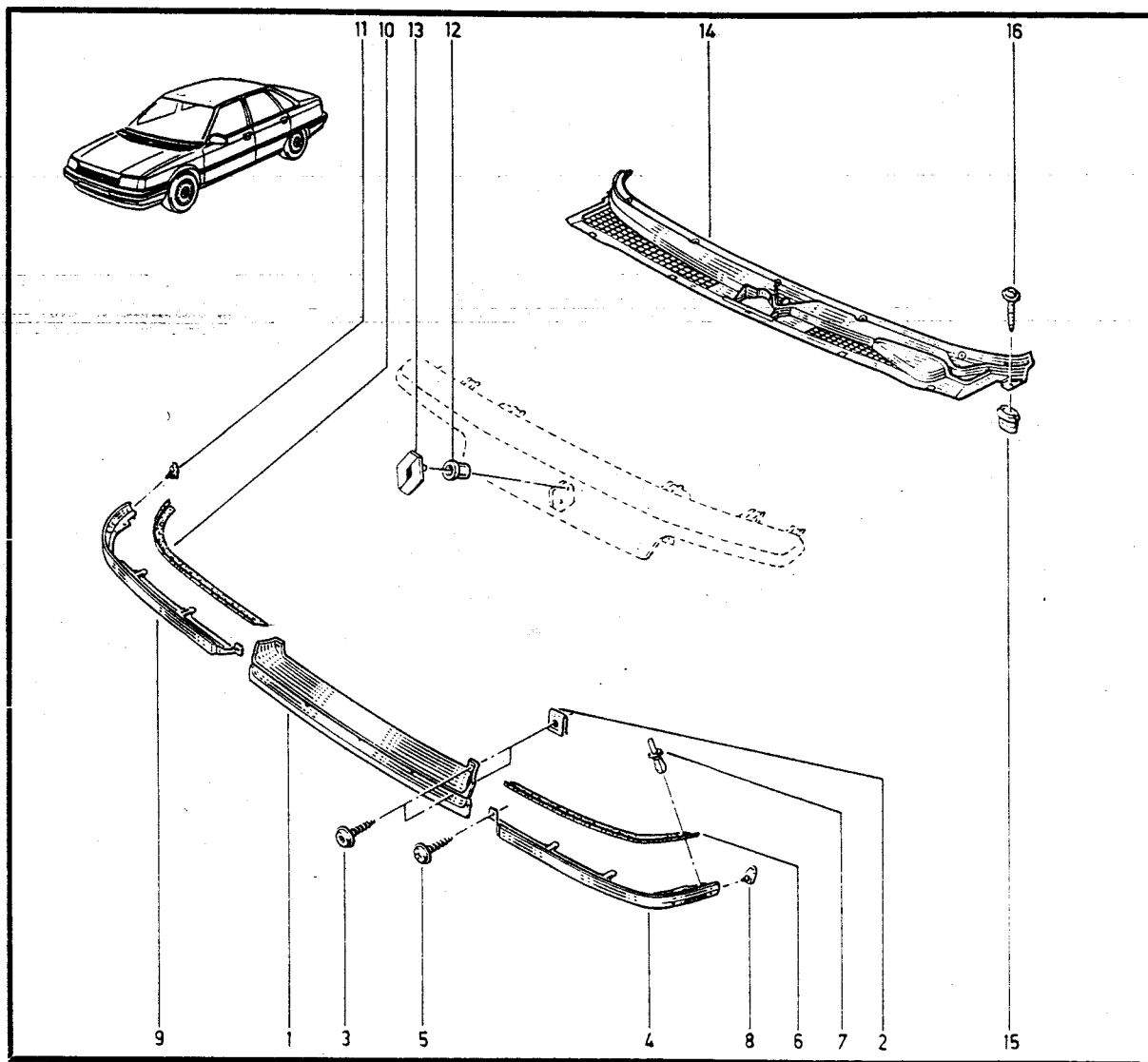

L48S		n° 11818		n°
L488		n° 1		n°
K488		n° 1		n°
K48S		n° 01947		n°
L48Z		n° 1		n°
K48G		n° 1		n°

L48X		n° 1		n°
L48K		n° 1		n°
K48Y		n° 1		n°
K48X		n° 1		n°
K487		n° 1		n°



56.02

P.R. 1233

- 1-77 01 366 487
- 2-77 00 817 027
- 3-77 02 091 528
- 4-77 02 219 492
- 5-77 00 784 431
- 6-77 00 774 567
- 7-77 03 081 151
- 8-77 00 826 996
- 9-77 02 219 417
- 10-77 00 830 388
- 11-77 00 793 876 (A)
- 77 01 366 370 (B)
- 12-77 01 366 369

56.02

P.R. 1233

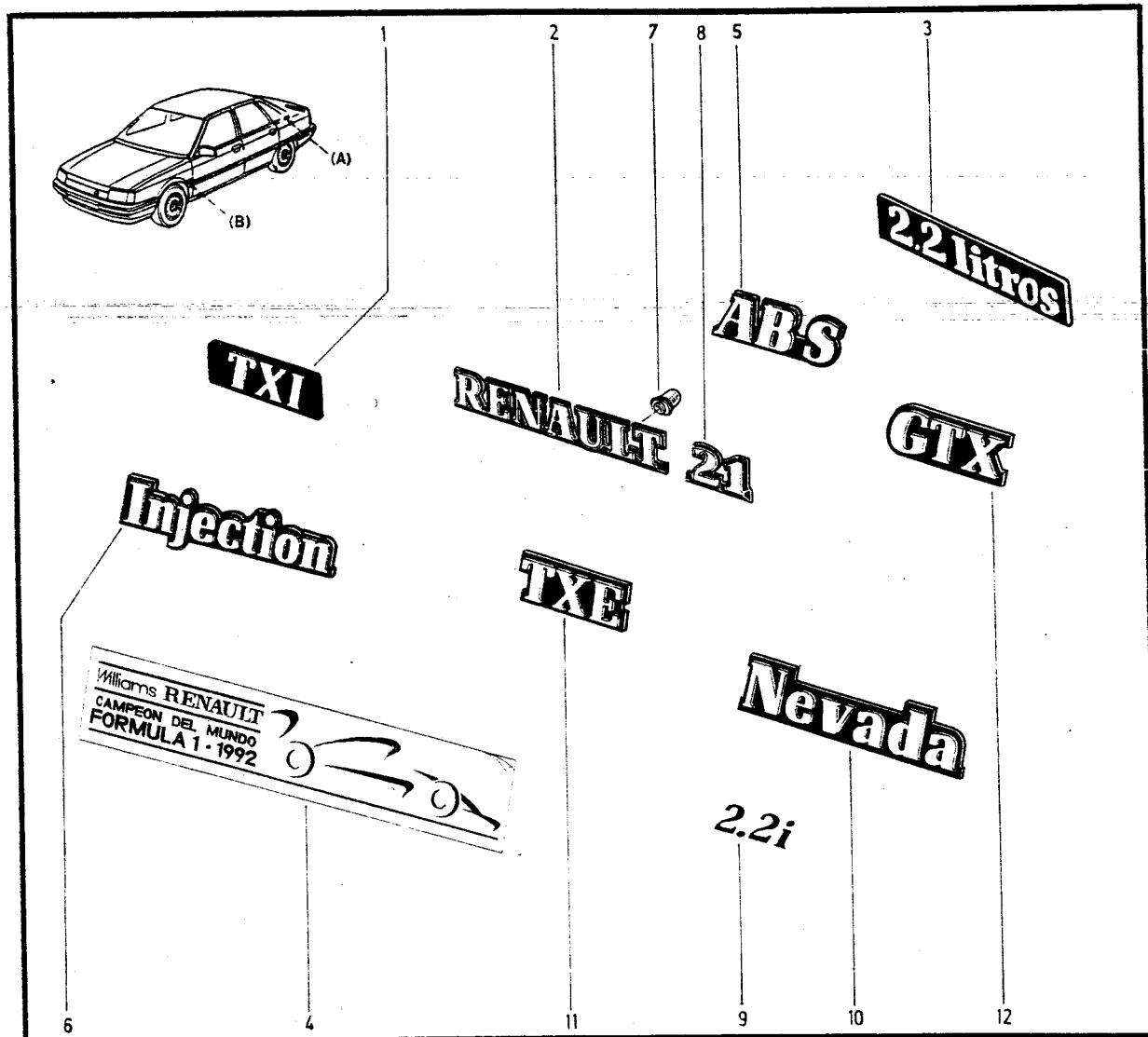

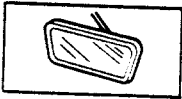

56.21

P.R. 1233

- 1- 77 00 900 541
- 2- 77 00 900 540
- 3- 79 03 032 010
- 4- 77 01 366 264
- 5- 77 01 366 261
- 6- 77 01 033 509
- 7- 77 01 366 263

56.21

P.R. 1233

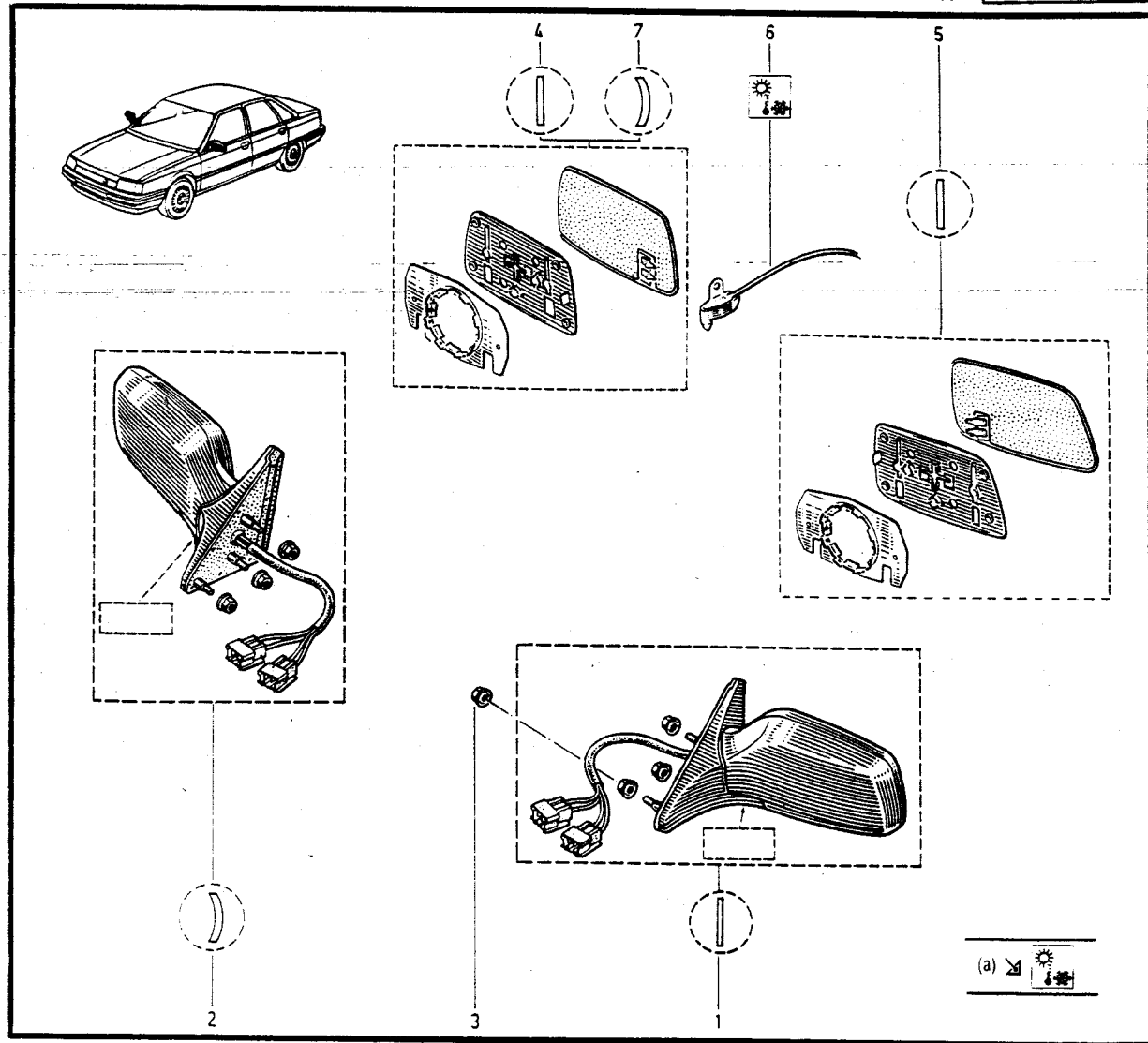

K48S	↔	n° 01947	⇨	n°
L48S	↔	n° 11818	⇨	n°
L48Z	↔	n° 1	⇨	n°
L48K	↔	n° 1	⇨	n°
K48X	↔	n° 1	⇨	n°
K48Y	↔	n° 1	⇨	n°
L48Y	↔	n° 1	⇨	n°

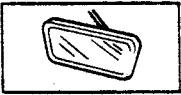

56.22
P.R. 1233

- 1- 77 00 768 141 (a)
- 77 02 213 807 (b)
- 2- 77 00 769 557 (a)
- 77 02 213 808 (b)
- 3- 77 03 033 027
- 4- 77 01 366 264
- 5- 77 01 366 261
- 6- 77 01 366 263

56.22
P.R. 1233

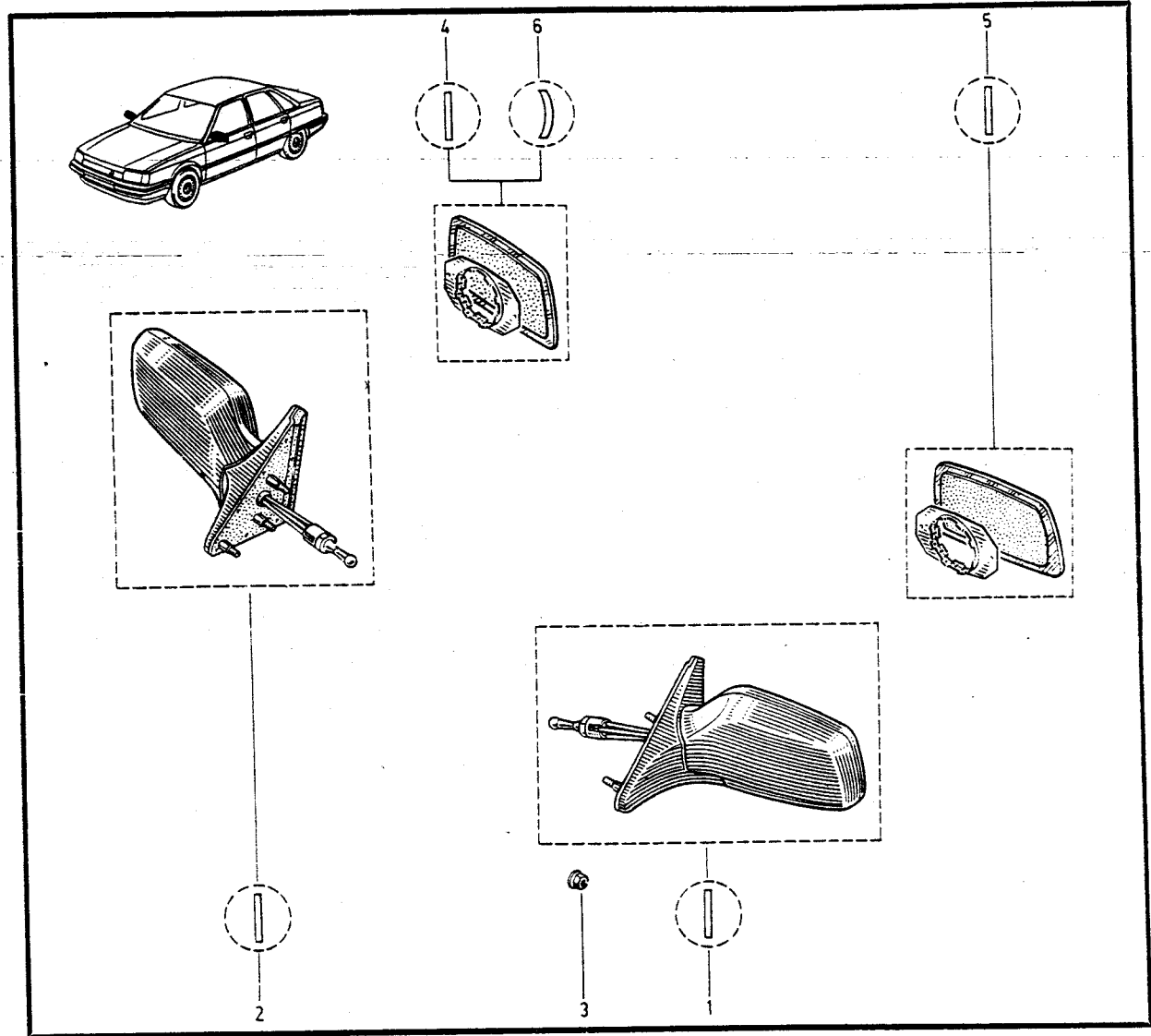
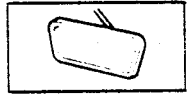

(a)	K489	⇄	n ²	1	⇄	n ⁰ 03253
	K488	⇄	n ²	1	⇄	n ⁰ 00437
(b)	K488	⇄	n ² 00438		⇄	n ²
	L488	⇄	n ²	1	⇄	n ²
	L48G	⇄	n ²	1	⇄	n ²



56.35.1

P.R. 1233

- 1-77 00 794 642
- 2-77 03 077 225
- 3-77 00 794 643
- 4-77 00 791 105
- 5-77 03 016 405
- 6-77 03 046 069
- 7-77 03 035 011
- 8-77 00 791 106

56.35.1

P.R. 1233

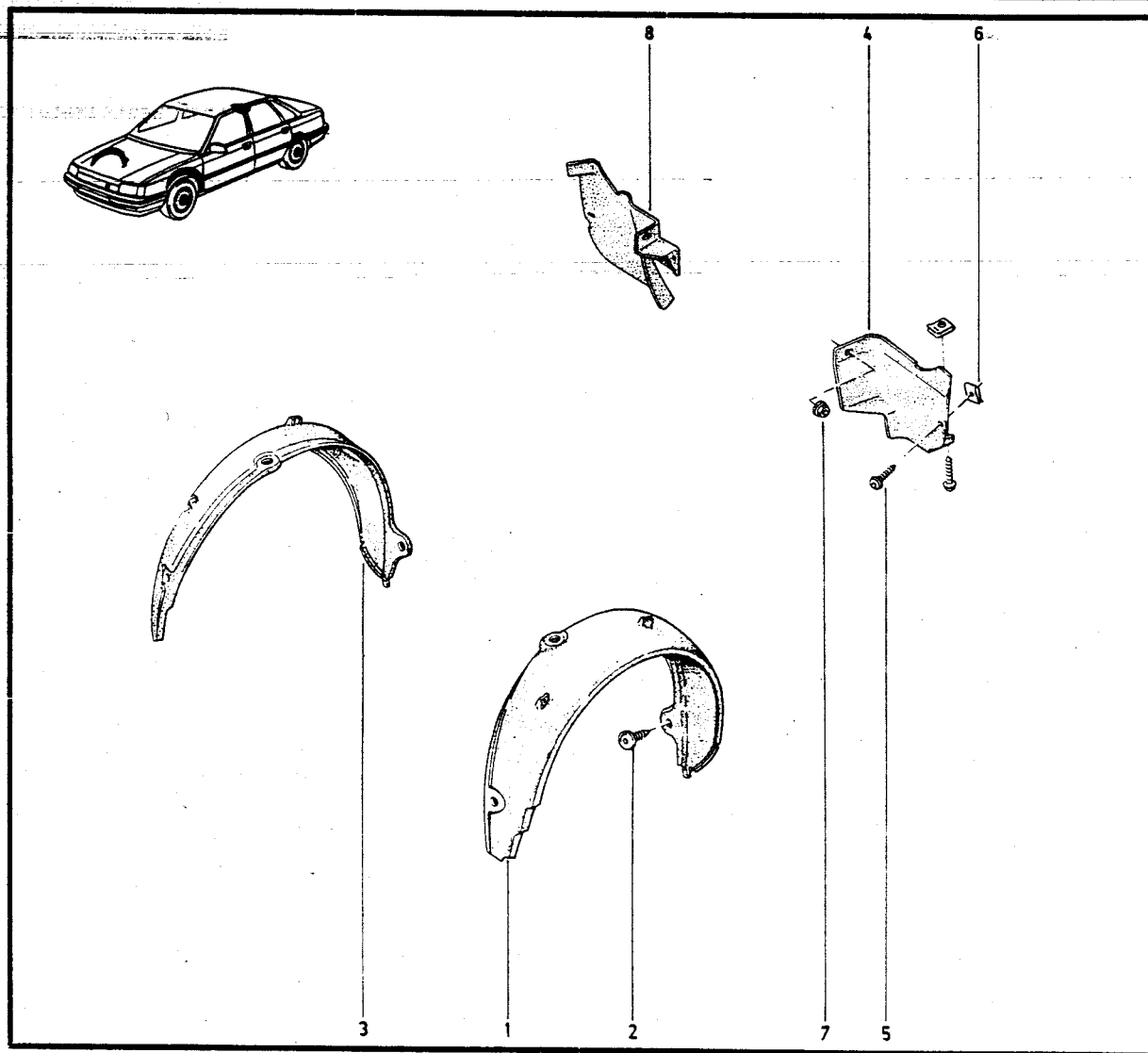

L48G	⇄	n²	1	⇨	n²
K487	⇄	n²	1	⇨	n²
K48Y	⇄	n²	1	⇨	n²
K48S	⇄	n² 0889	⇨	n²	
L48S	⇄	n² 06087	⇨	n²	

L489	⇄	n²	1	⇨	n²
K489	⇄	n²	1	⇨	n²
L488	⇄	n²	1	⇨	n²
K488	⇄	n²	1	⇨	n²
L48Z	⇄	n²	1	⇨	n²

L48K	⇄	n²	1	⇨	n²
L48X	⇄	n²	1	⇨	n²
L48Y	⇄	n²	1	⇨	n²
K48Y	⇄	n²	1	⇨	n²



56.40

P.R. 1233

15

56.40

P.R. 1233



1-77 00 770 369

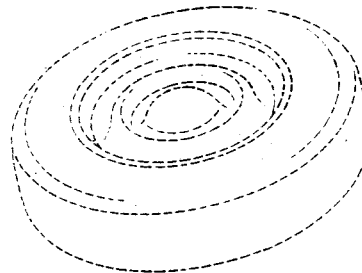
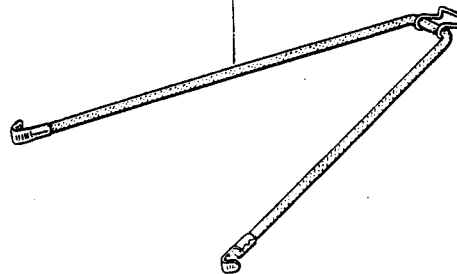
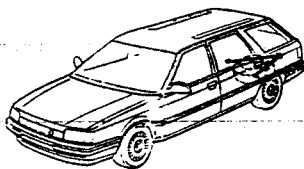

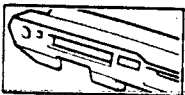

57.02

P.R. 1233

57.02

P.R. 1233



- 1-77 01 367 105
- 2-77 00 796 179
- 3-77 00 804 949
- 4-77 03 001 904
- 5-77 03 053 032
- 6-77 03 032 131
- 7-77 00 789 417
- 8-77 00 764 288
- 9-77 00 768 040
- 10-77 00 804 334
- 11-77 00 765 175
- 12-77 00 764 289
- 13-77 00 804 335
- 14-77 03 046 098
- 15-77 03 053 172
- 16-77 03 016 285
- 17-77 00 763 704
- 18-77 00 766 728
- 19-77 03 016 485
- 20-77 03 388 015
- 21-77 00 791 750
- 22-77 00 790 326
- 23-77 00 790 325
- 24-77 00 786 106
- 25-77 03 006 115
- 26-77 03 049 048
- 27-77 00 797 381
- 28-77 01 366 985
- 29-77 00 795 052
- 30-77 01 367 284

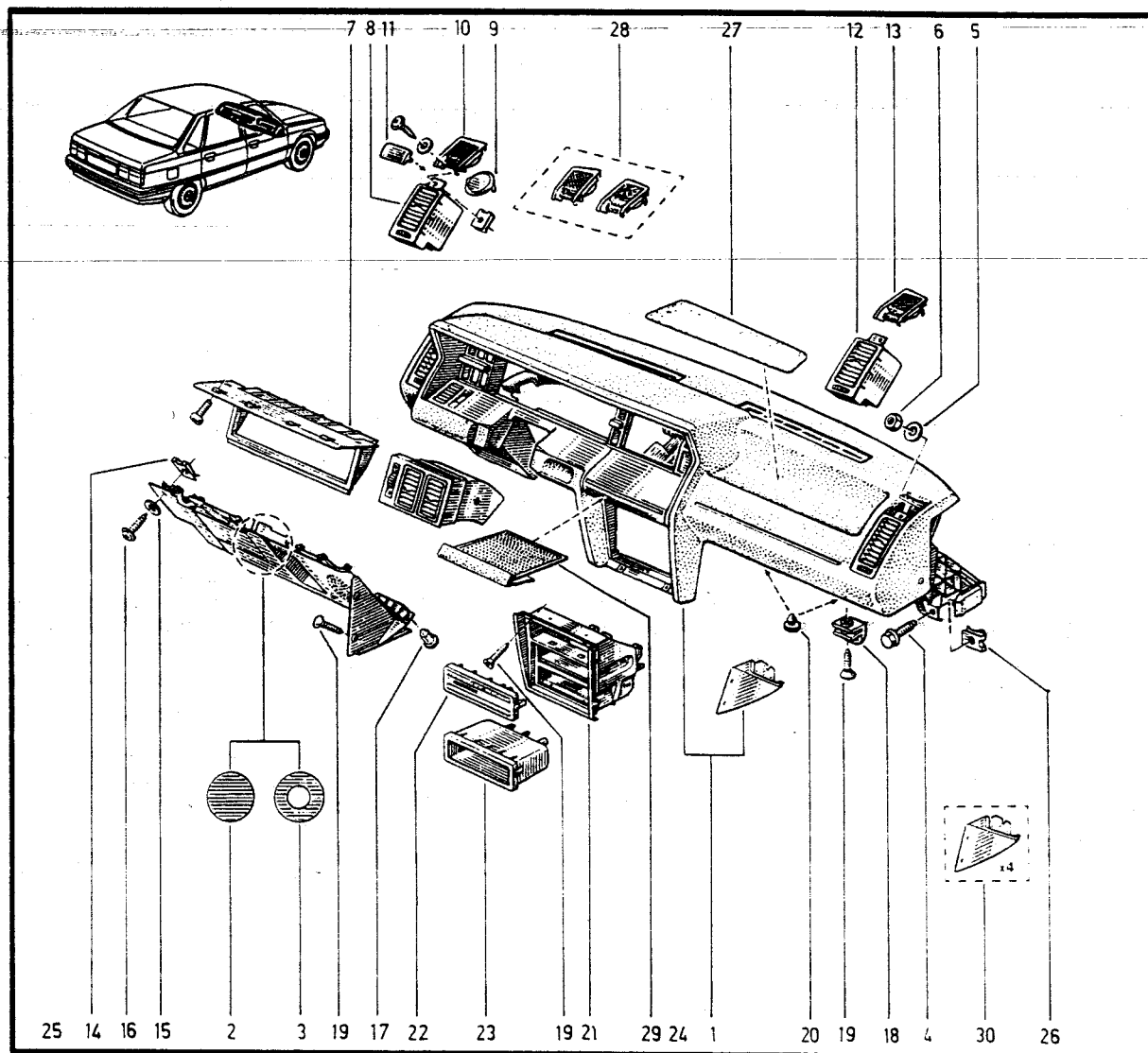

K48S	⇄	n²	01947	⇄	n²
L48S	⇄	n²	11818	⇄	n²
L488	⇄	n²	1	⇄	n²
K488	⇄	n²	1	⇄	n²
L48Z	⇄	n²	1	⇄	n²

L48K	⇄	n²	1	⇄	n²
L48X	⇄	n²	1	⇄	n²
L48G	⇄	n²	1	⇄	n²
L48Y	⇄	n²	1	⇄	n²
K48Y	⇄	n²	1	⇄	n²

K48G	⇄	n²	1	⇄	n²
K48X	⇄	n²	1	⇄	n²
K487	⇄	n²	1	⇄	n²

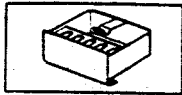

57.30

P.R. 1233

57.30

P.R. 1233

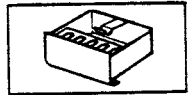

- 1- 77 00 766 122
- 2- 77 03 072 048
- 3- 77 00 772 695
- 4- 77 00 780 808
- 5- 77 05 028 076
- 6- 77 00 775 647

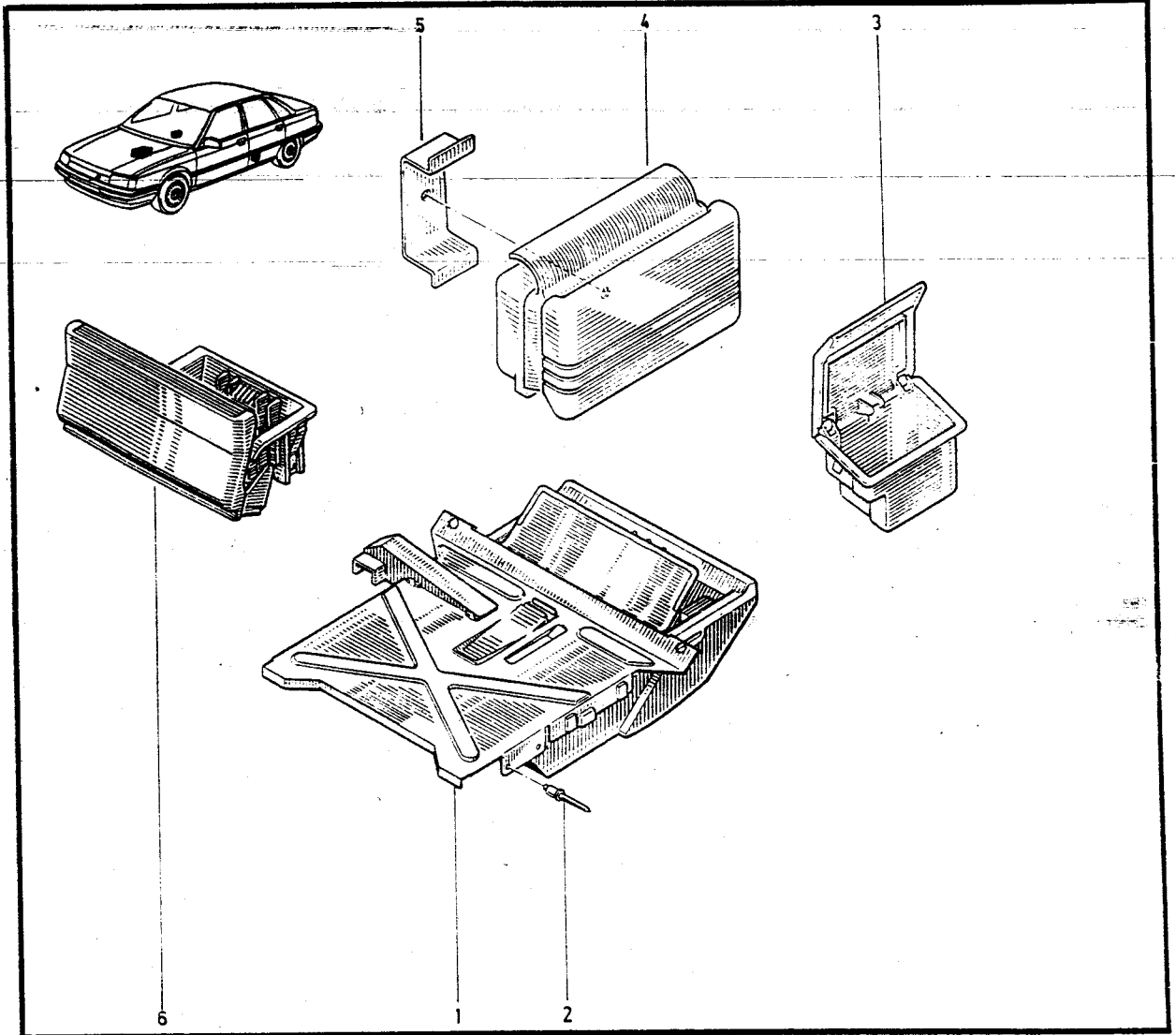

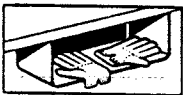

58.01

P.R. 1233

- 1- 77 00 764 737 [22]
- 2- 77 00 778 394
- 3- 77 00 778 699
- 4- 77 00 691 527
- 5- 77 03 016 410
- 6- 77 00 772 979

58.01

P.R. 1233

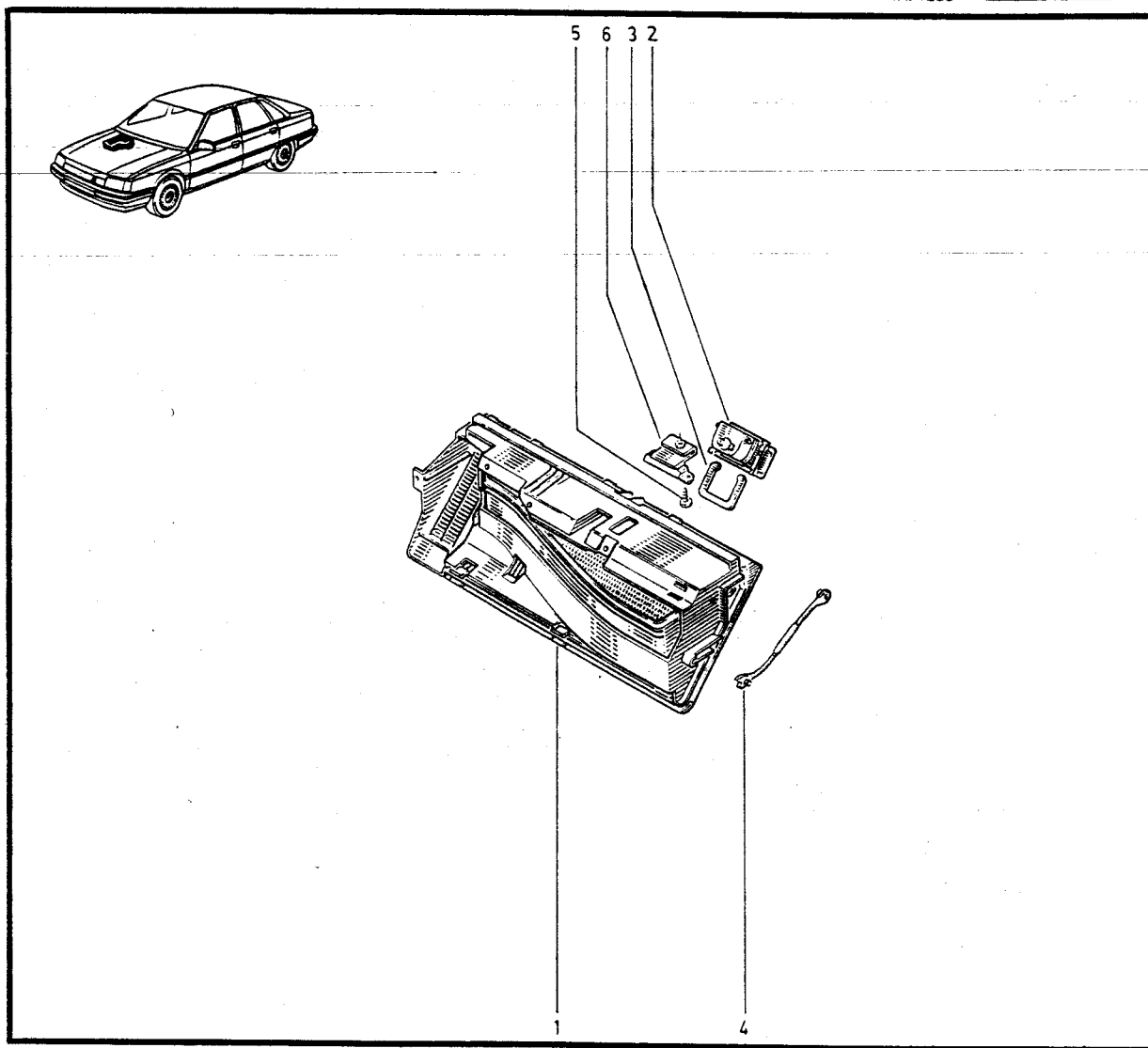
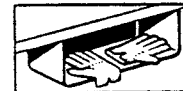



58.20

P.R. 1233

58.20

P.R. 1233



- 1- 77 02 211 436
- 2- 77 02 071 788
- 3- 77 02 211 435

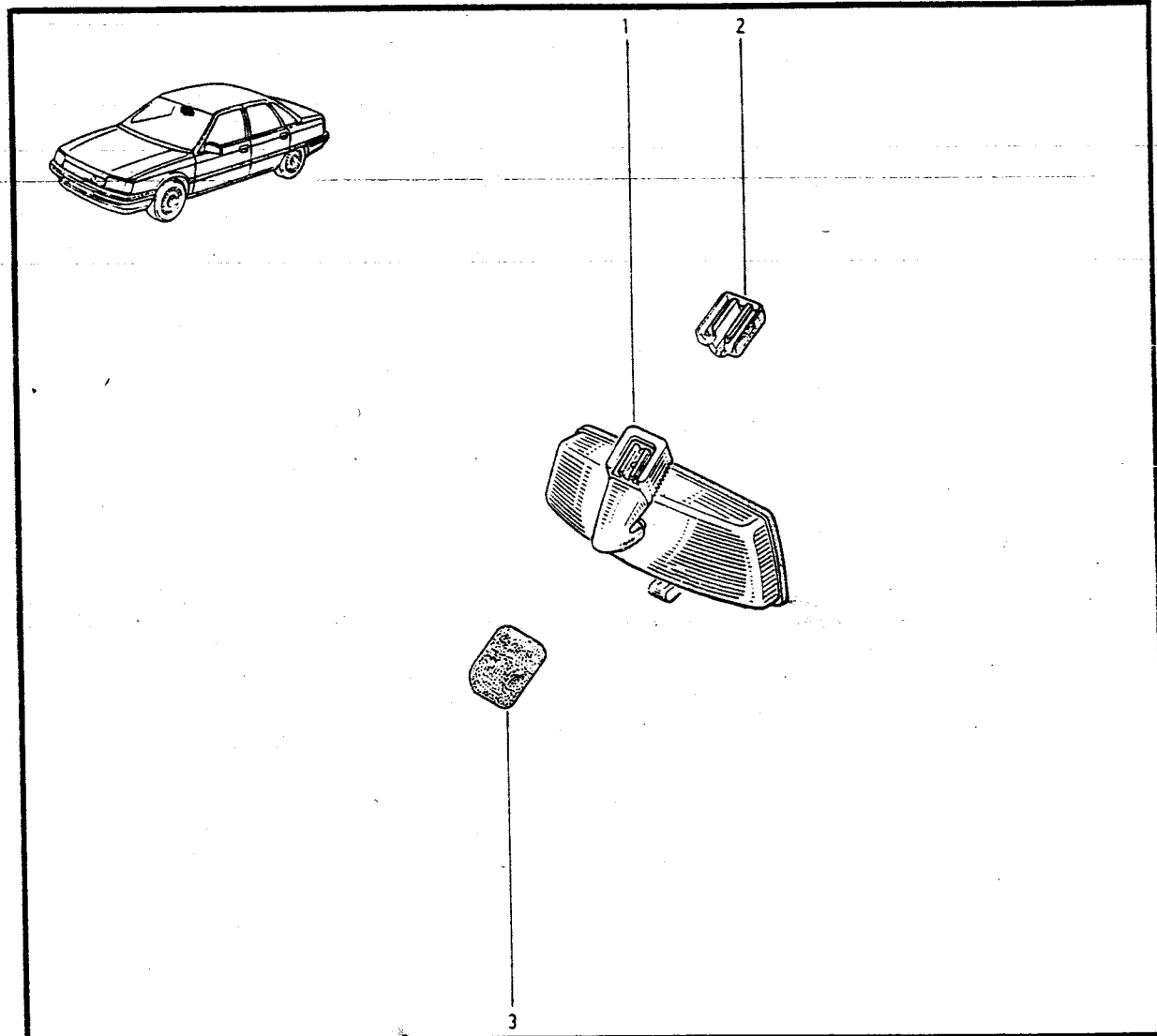

L48S	↔	n° 07096	⇒	n°
K48S	↔	n° 01003	⇒	n°
L489	↔	n° 00609	⇒	n°
K489	↔	n° 00255	⇒	n°
L488	↔	n° 1	⇒	n°

L48K	↔	n° 1	⇒	n°
L48Z	↔	n° 1	⇒	n°
K488	↔	n° 1	⇒	n°
L48X	↔	n° 1	⇒	n°
K48X	↔	n° 1	⇒	n°

K48G	↔	n° 1	⇒	n°
L48G	↔	n° 1	⇒	n°
L48Y	↔	n° 1	⇒	n°
K48Y	↔	n° 1	⇒	n°
K487	↔	n° 1	⇒	n°



59.30

P.R. 1233

59.30

P.R. 1233



- 1 - 77 02 098 063 (D)(B)
- 77 02 098 067 (C)(B)
- 2 - 77 01 000 957
- 3 - 77 00 767 807
- 4 - 77 02 098 072 (D)(B)
- 77 02 098 074 (C)(B)
- 5 - 77 02 098 071 (D)(A)
- 77 02 098 073 (C)(A)
- 6 - 77 02 081 436
- 7 - 77 05 098 008
- 8 - 77 00 639 743
- 9 - 77 05 098 042
- 10 - 77 02 098 062 (D)(A)
- 77 02 098 066 (C)(A)
- 11 - 77 02 098 070 (C)
- 77 02 098 069 (D)

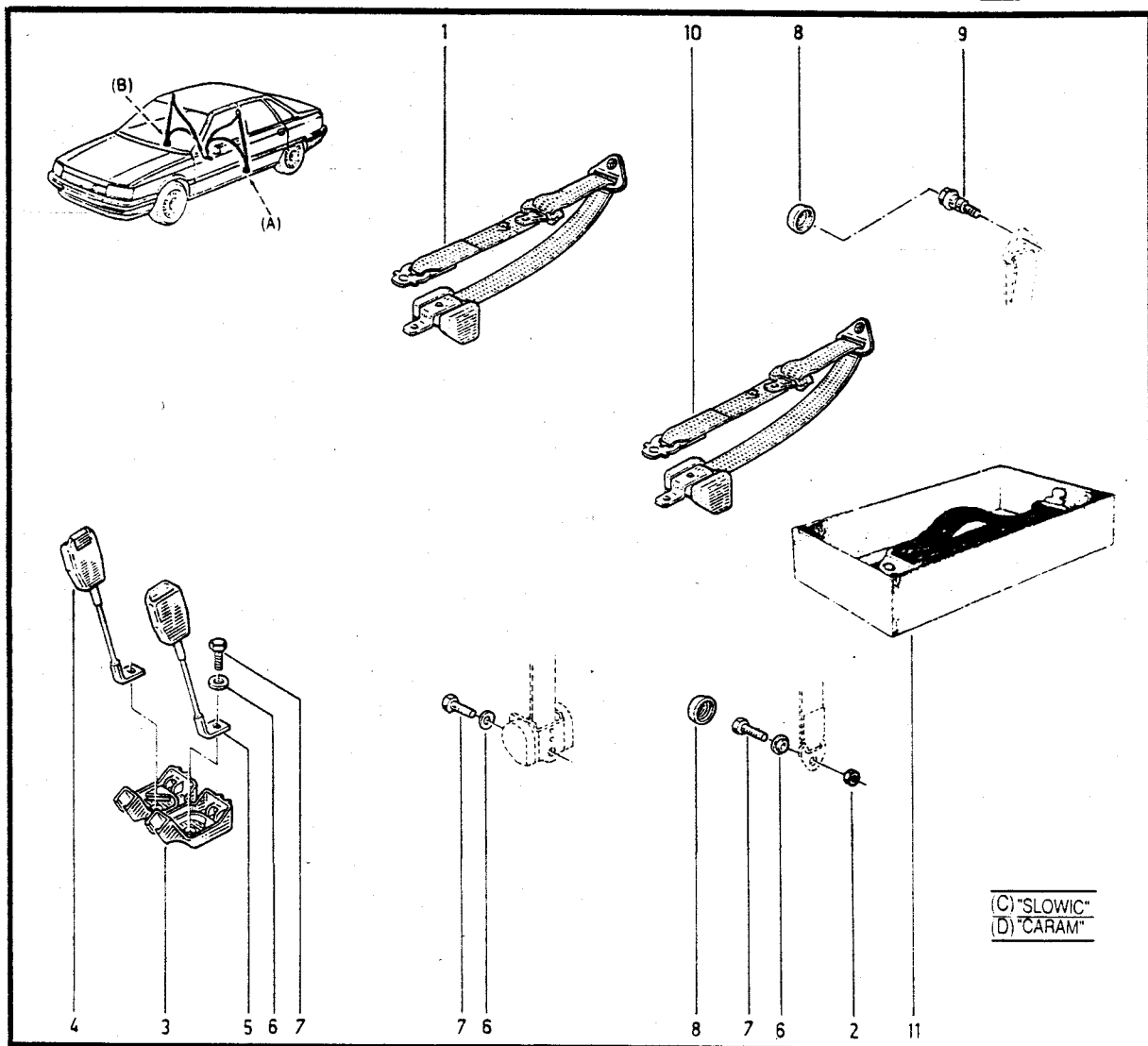



59.50

P.R. 1233

59.50

P.R. 1233



- 1- 77 02 206 138 (A)
- 2- 77 02 098 170 (B)
- 3- 77 02 206 110 (A)
- 77 02 081 737 (B)
- 4- 77 00 673 971
- 5- 79 03 056 048
- 6- 77 02 060 826
- 7- 77 03 053 544
- 8- 2 210 356
- 9- 77 01 000 955
- 10- 77 01 000 957
- 11- 77 02 081 436
- 12- 77 02 206 243 (B)
- 13- 77 02 206 244 (B)
- 14- 77 02 098 529 (B)
- 77 02 098 740 (A)
- 15- 77 02 098 168 (A)
- 77 02 098 167 (B)†

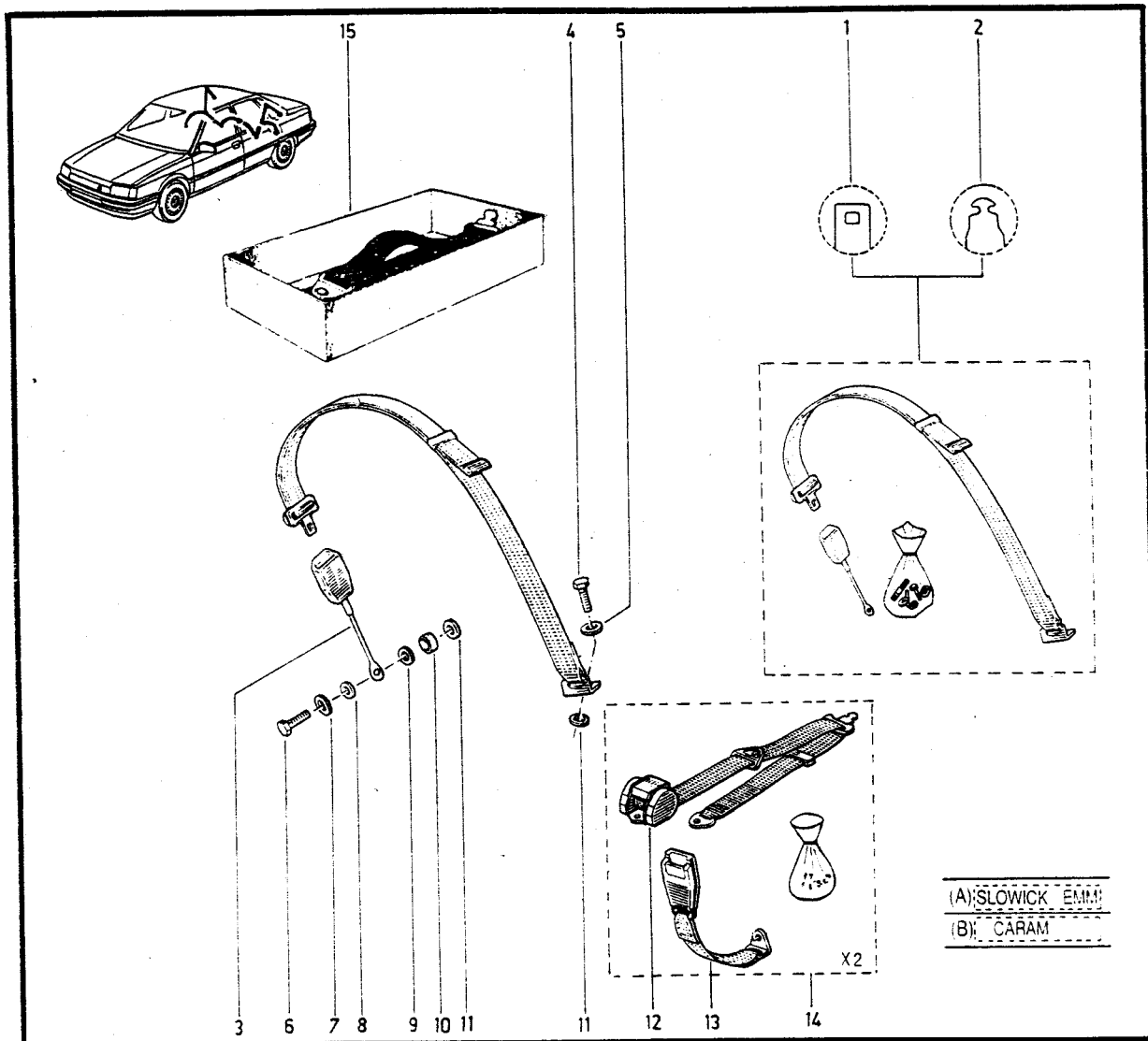

- K488
- L488
- K489
- L489
- L48Z
- L48S
- L48Y
- K487



59.55

P.R. 1233

- 1- 77 02 206 251
- 2- 77 02 206 253
- 3- 77 02 206 252
- 4- 79 03 056 048
- 5- 77 02 098 741

59.55

P.R. 1233

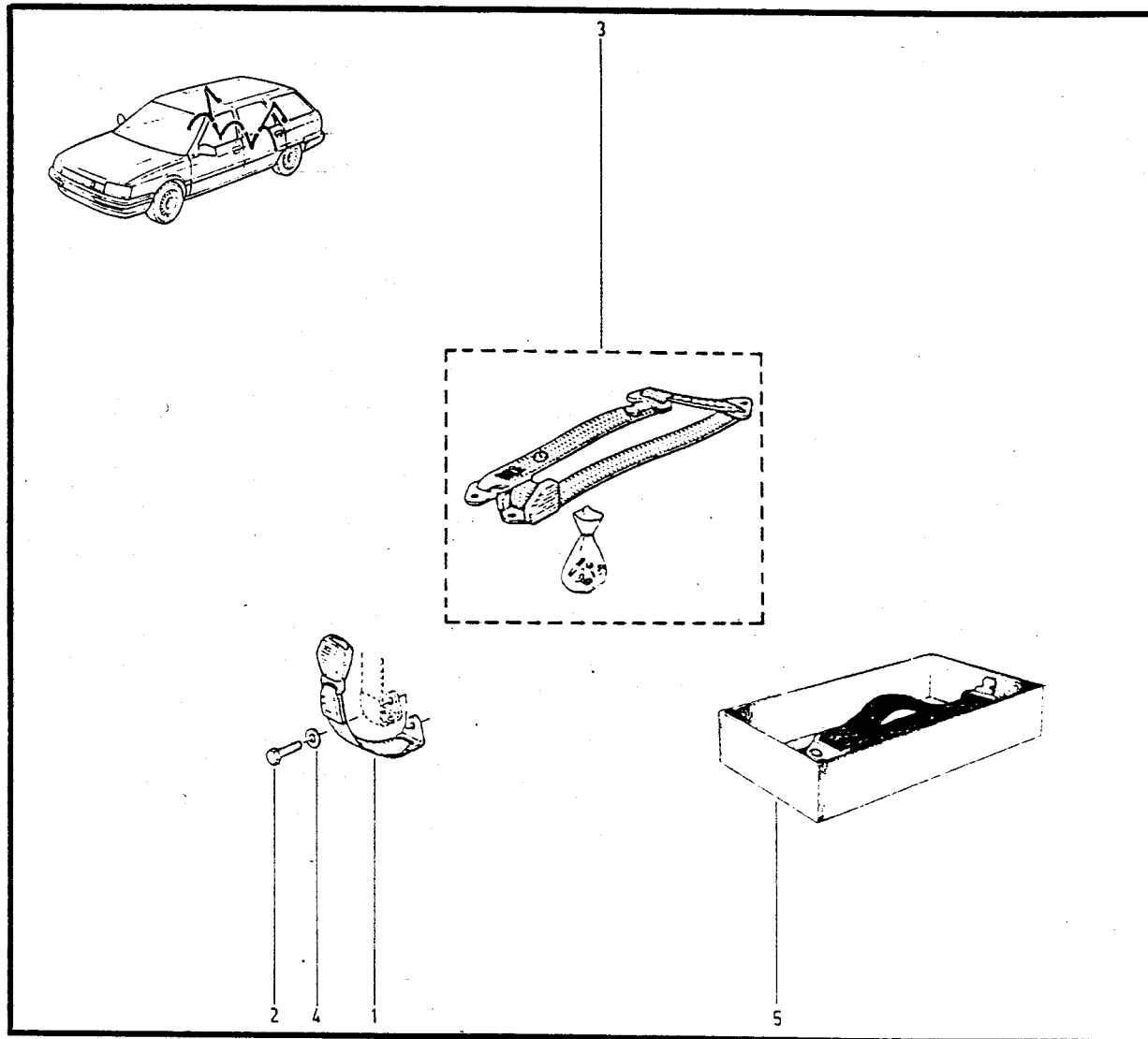

K48S
K48Y



59.56

P.R. 1233

59.56

P.R. 1233



- 1- 77 02 213 779 (c) †
- 77 02 098 741 (c)
- 77 02 213 804 (a)
- 2- 77 02 213 802 (b)
- 3- 77 02 213 800 (b)
- 4- 77 02 213 778 (b)

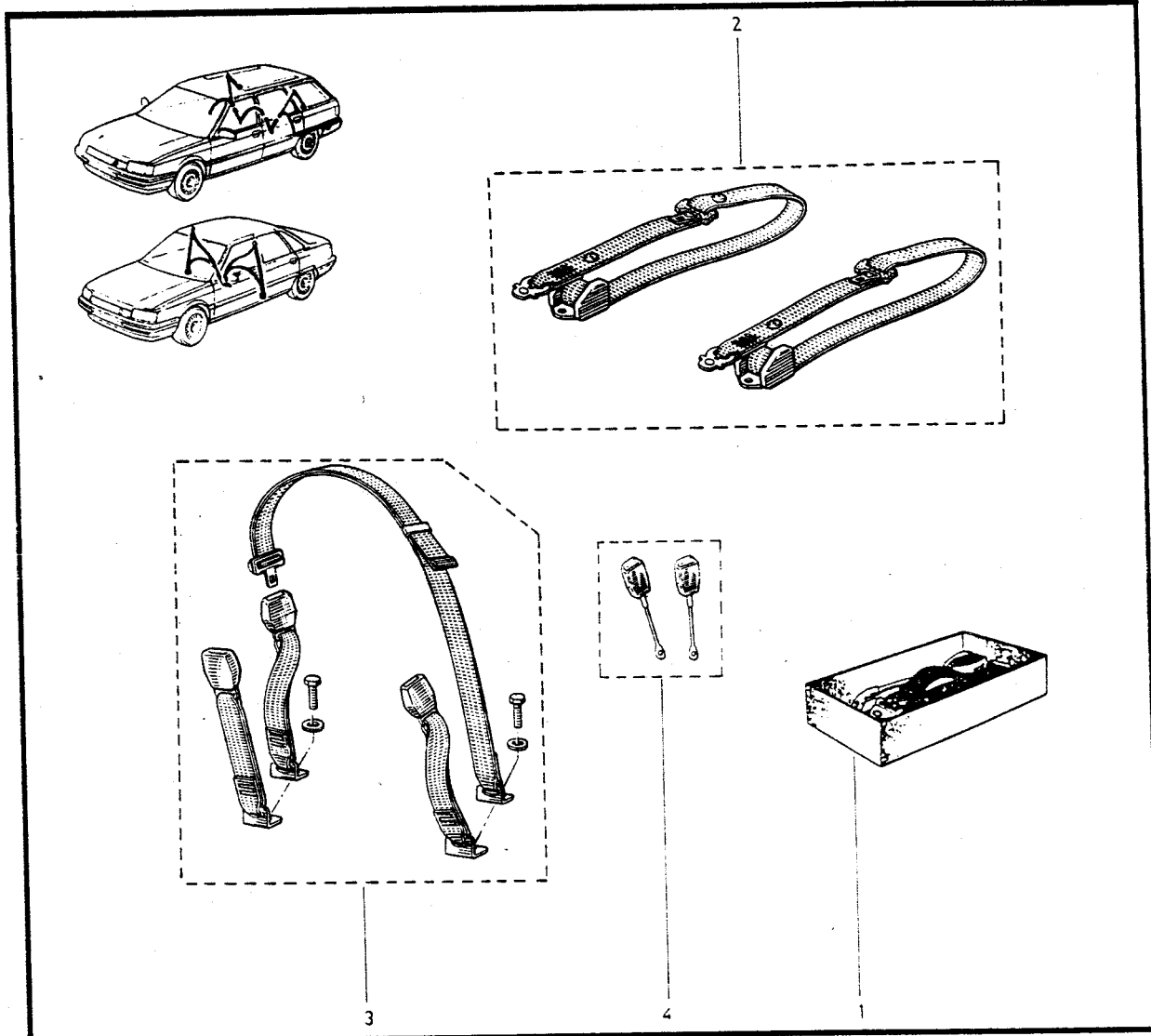

- (a) / L48S - L48K - L48X
- (b) / K48S - K48Y - K48X
- (c) / K489 - K48X



59.58
P.R. 1233

1-77 02 213 803
2-77 02 213 801

L

59.58
P.R. 1233

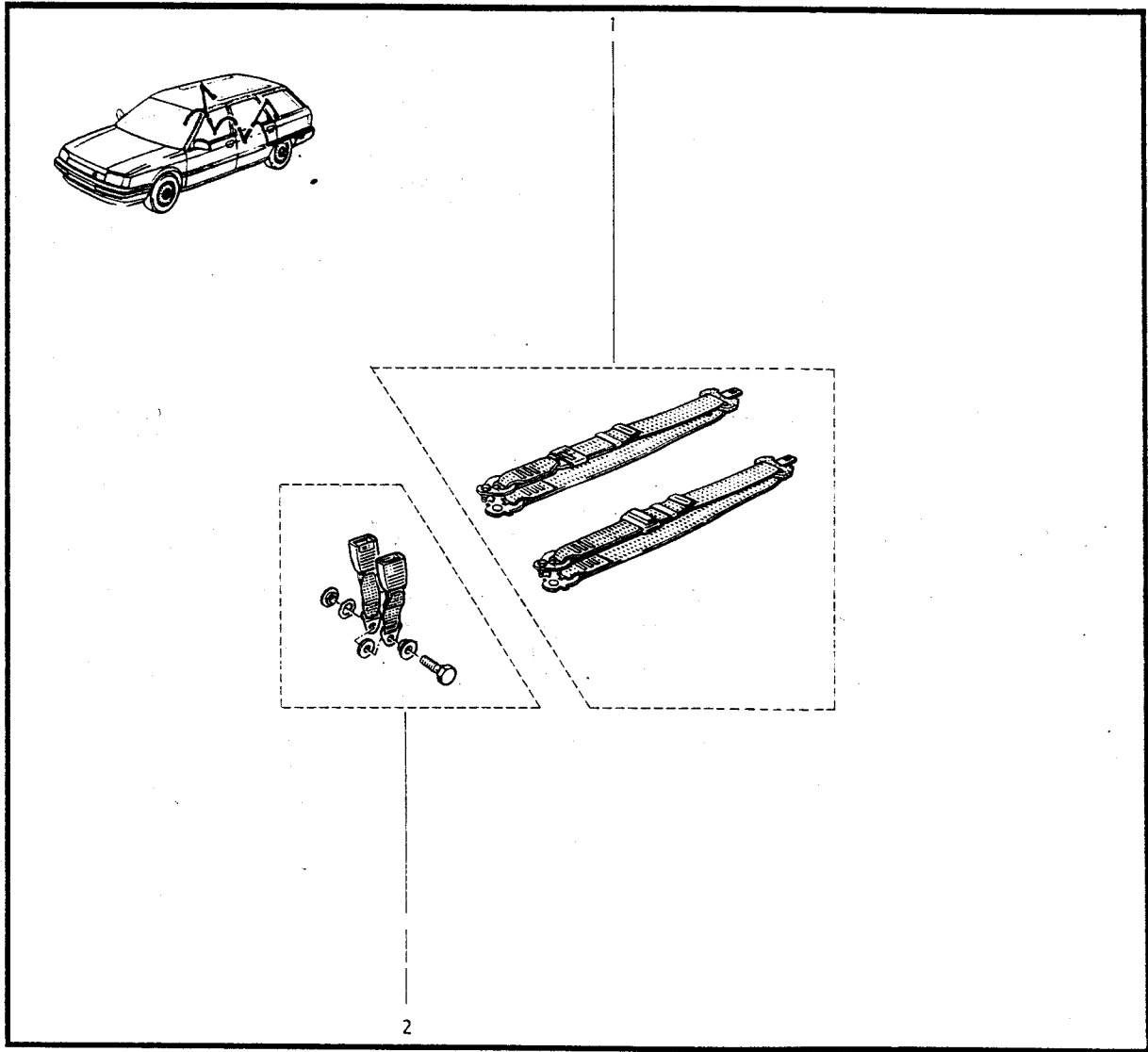



59.80

P.R. 1233

- 1 - 77 00 773 848
- 2 - 77 03 061 048
- 3 - 77 03 033 027
- 4 - 77 03 065 190
- 5 - 77 03 065 191
- 6 - 77 00 772 908

59.80

P.R. 1233

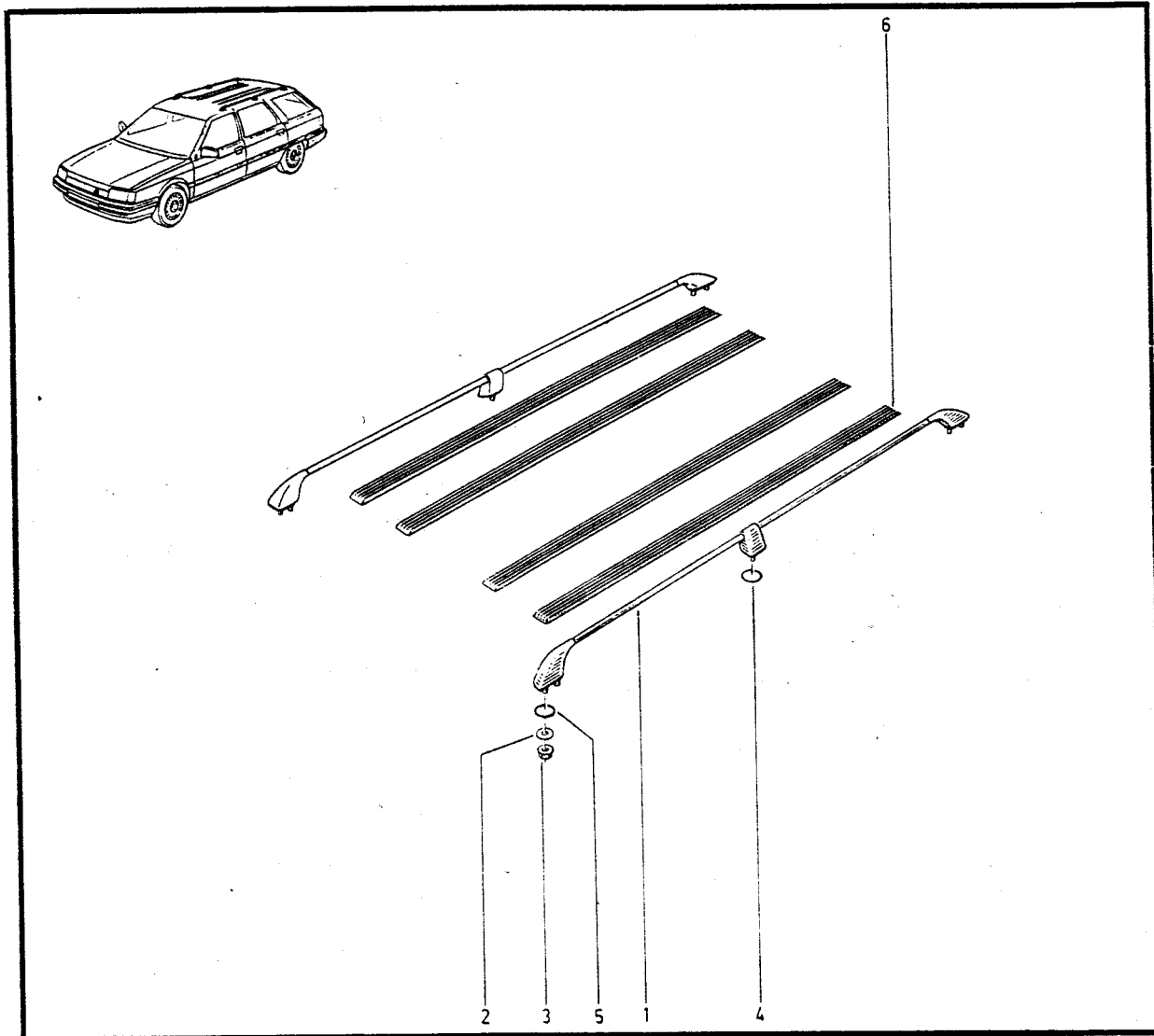
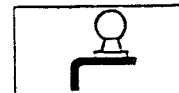

K48G		n ²	1		n ²
K48S		n ²	1		n ²
K48X		n ²	1		n ²
K488		n ²	1		n ²
K487		n ²	1		n ²
K48Y		n ²	1		n ²

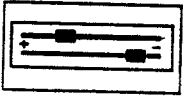

60.10

P.R. 1233

- 1 - 77 00 772 743
- 2 - 77 00 772 741
- 3 - 77 00 764 643
- 4 - 77 00 764 641
- 5 - 77 03 016 407

60.10

P.R. 1233

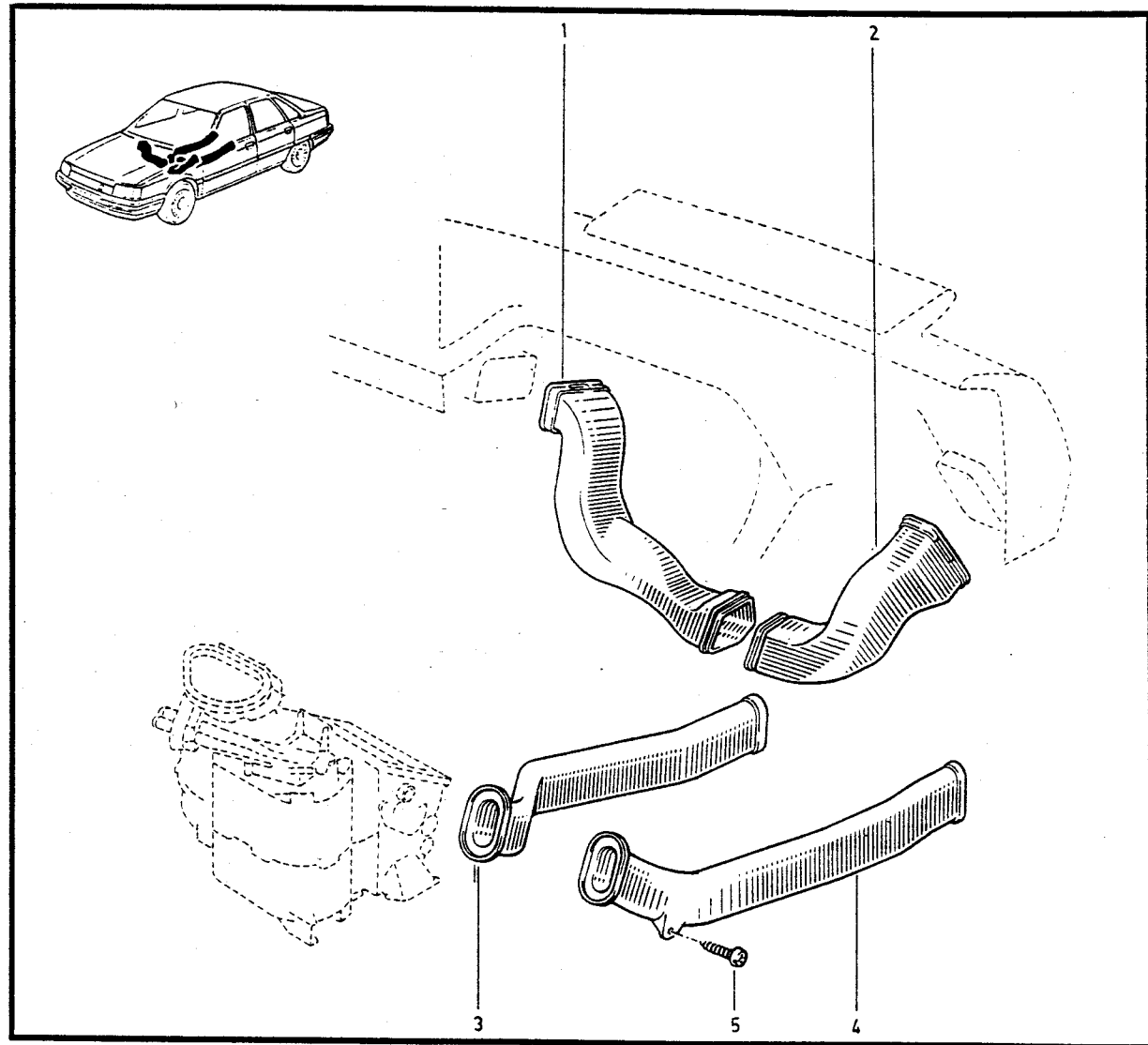
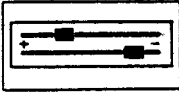

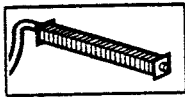

61.01
P.R. 1233

61.01
P.R. 1233



- 1- 77 73 083 324
- 2- 77 00 767 134
- 3- 77 03 083 269
- 4- 77 02 086 433
- 5- 77 02 057 172
- 6- 77 73 083 327
- 7- 77 02 205 219
- 8- 77 02 205 218
- 9- 77 03 079 128
- 10- 77 73 083 325
- 11- 77 02 205 238
- 12- 77 02 094 588
- 13- 77 73 083 331

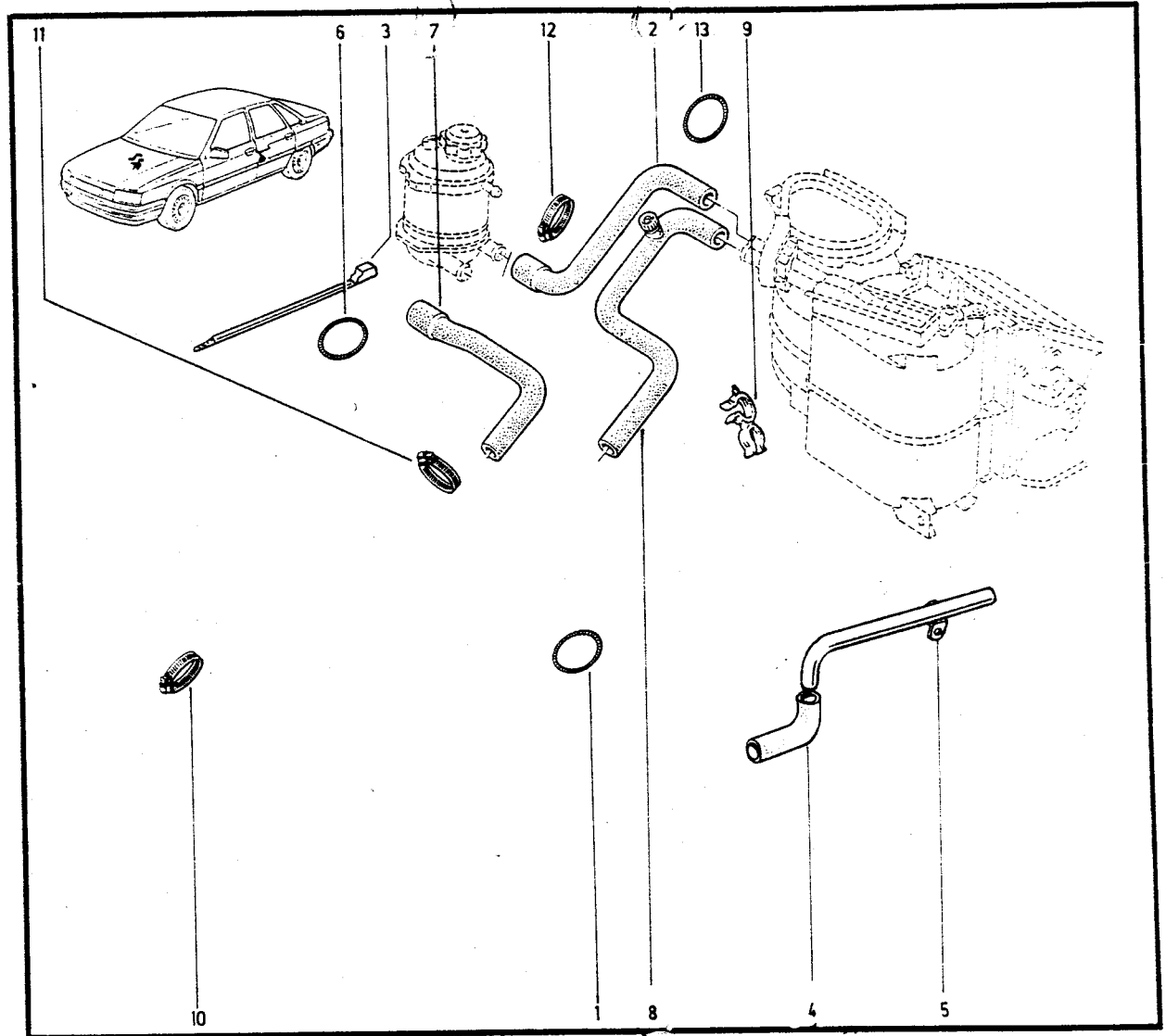

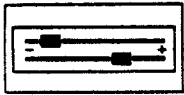

61.20

P.R. 1233

61.20

P.R. 1233

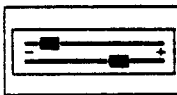

- 1- 77 01 032 837 (a)
- 2- 77 01 349 811 (a)
- 77 01 203 202 (b)
- 3- 77 03 076 099
- 4- 77 01 032 302
- 5- 77 02 085 058
- 6- 77 02 206 224 (a)
- 7- 77 02 206 223 (a)
- 8- 77 02 072 739
- 9- 77 02 206 225
- 10- 77 02 206 927
- 11- 77 01 034 355 (b)
- 12- 77 00 766 661
- 13- 77 00 761 132
- 14- 77 03 097 184
- 15- 77 03 080 031
- 16- 77 00 776 876

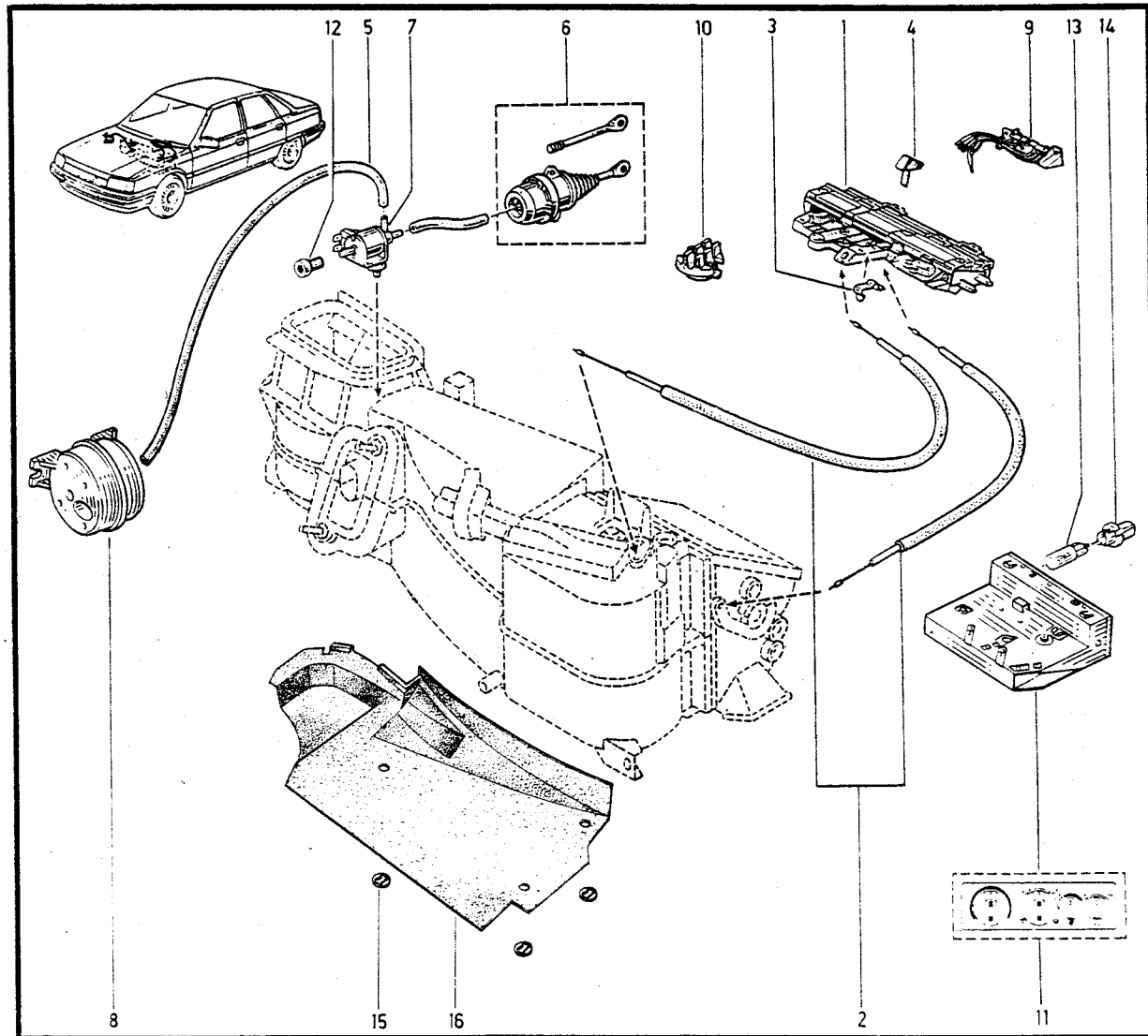

(a)	L48S ↔ n° 00889 ↔ n° 11817
	L489 ↔ n° 1 ↔ n°
	K48S ↔ n° 1 ↔ n° 01946
	K489 ↔ n° 1 ↔ n°

(b)	L48S ↔ n° 11818 ↔ n°
	K48S ↔ n° 01947 ↔ n°
	K488 ↔ n° 1 ↔ n°
	L48Z - L48Y - L48K 208/209 - K48X 210
	L488 - L48G 202 - K48G 202 - K48Y

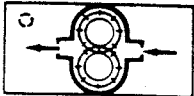

62.23
P.R. 1233

(a)

62.23
P.R. 1233

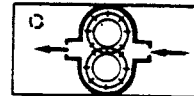

- 1-77 02 238 080
- 2-77 01 202 735
- 3-77 03 053 037
- 4-77 03 055 011
- 5-77 00 730 668
- 6-77 02 086 825
- 7-77 00 729 245
- 8-77 00 729 330
- 9-77 03 101 070
- 10-77 03 053 138
- 11-77 03 101 045
- 12-77 03 101 073
- 13-77 01 202 734
- 14-77 03 055 013
- 15-77 03 032 103
- 16-77 03 101 075
- 17-77 03 001 162
- 18-77 01 202 738 (x=112)
- 19-77 01 202 732
- 20-77 02 073 529

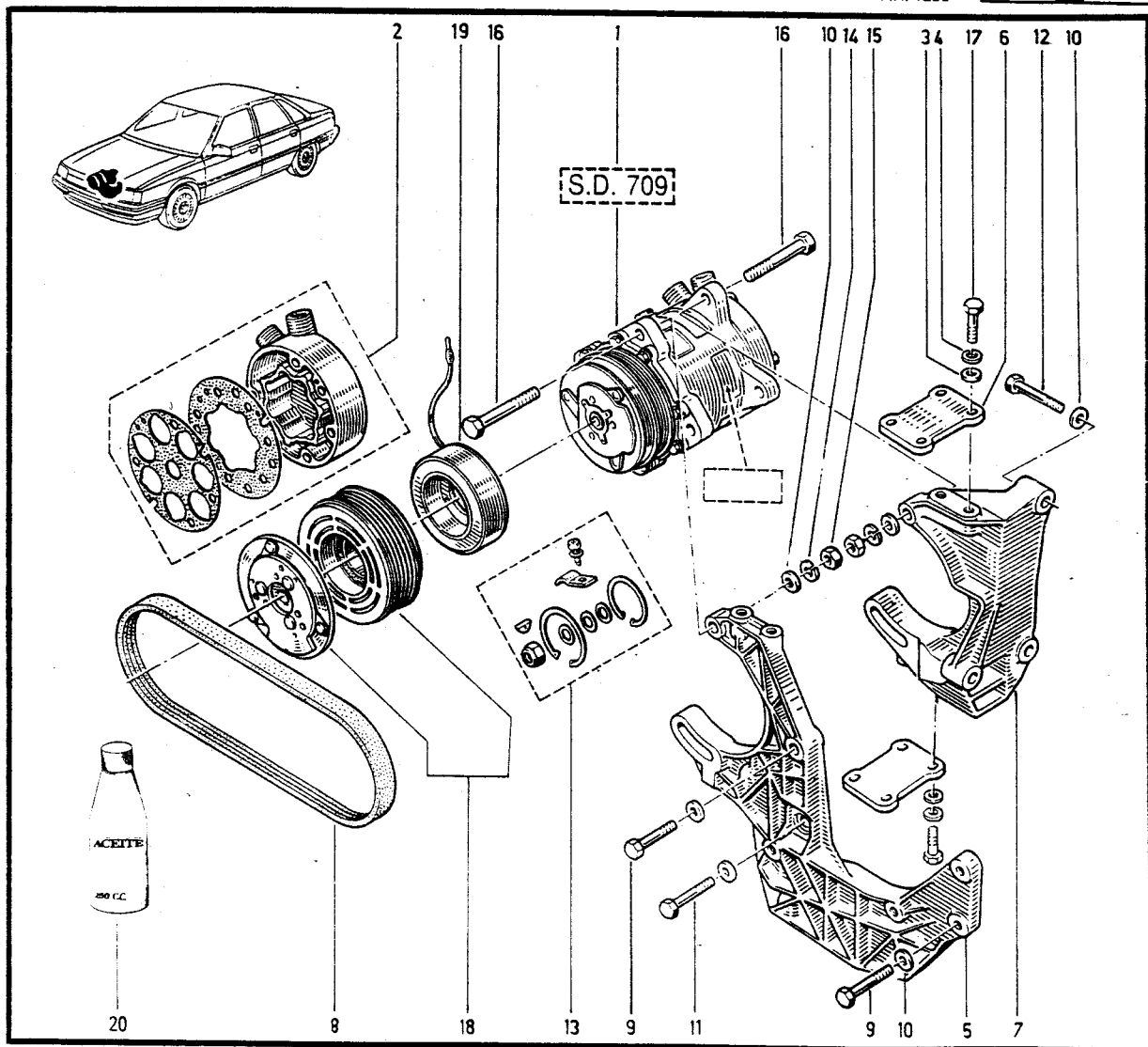

(a)	K48S		n°	1	⇔	n° 1207
	K489		n°	1	⇔	n° 1016
	L48S		n°	1	⇔	n° 9449
	L489		n°	1	⇔	n° 2030



62.24
P.R. 1233

62.24
P.R. 1233

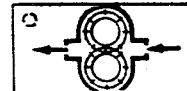

- 1-77 02 216 559
- 2-77 02 087 245 †
- 77 02 217 437
- 3-77 03 053 037
- 4-77 03 055 011
- 5-77 02 087 305
- 6-77 02 086 825
- 7-77 00 729 245
- 8-77 03 101 075
- 9-77 03 101 070
- 10-77 03 053 138
- 11-77 03 101 045
- 12-77 03 101 073
- 13-77 03 001 162
- 14-77 03 055 013
- 15-77 03 032 103
- 16-77 02 073 529

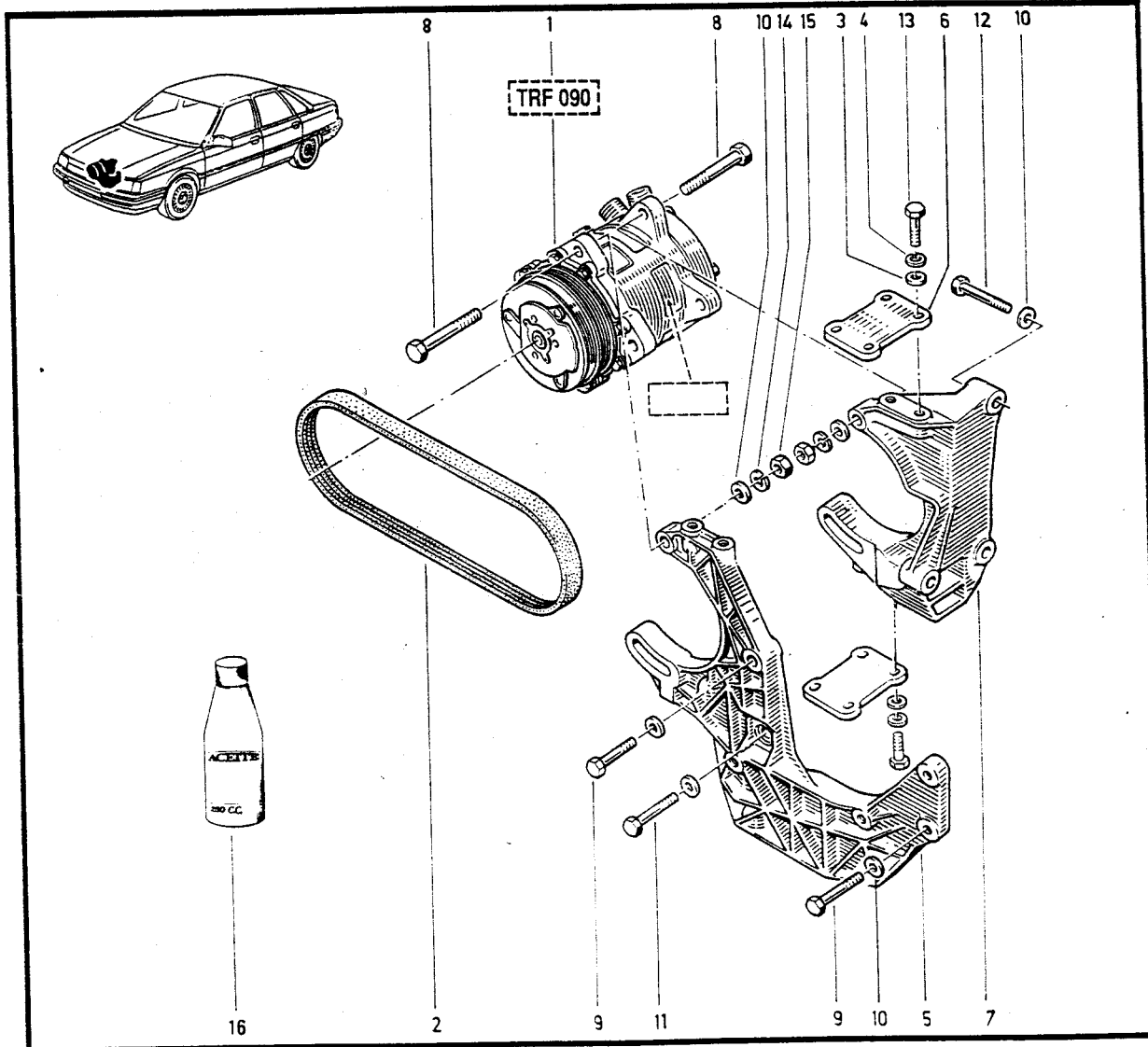

K48S	⇄	n°	1208	⇄	n°
K489	⇄	n°	1017	⇄	n°
L48S	⇄	n°	9450	⇄	n°
L489	⇄	n°	2031	⇄	n°
K487	⇄	n°	1	⇄	n°

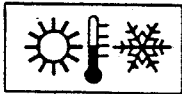

62.30

P.R. 1233



62.30

P.R. 1233



- 1- 77 01 202 603
- 2- 77 02 217 154
- 3- 77 03 217 155
- 4- 77 01 032 297
- 5- 77 01 202 530
- 6- 77 02 206 221
- 7- 77 01 034 990
- 8- 77 01 027 865
- 9- 77 01 202 601
- 10- 77 02 205 157
- 11- 77 02 217 152

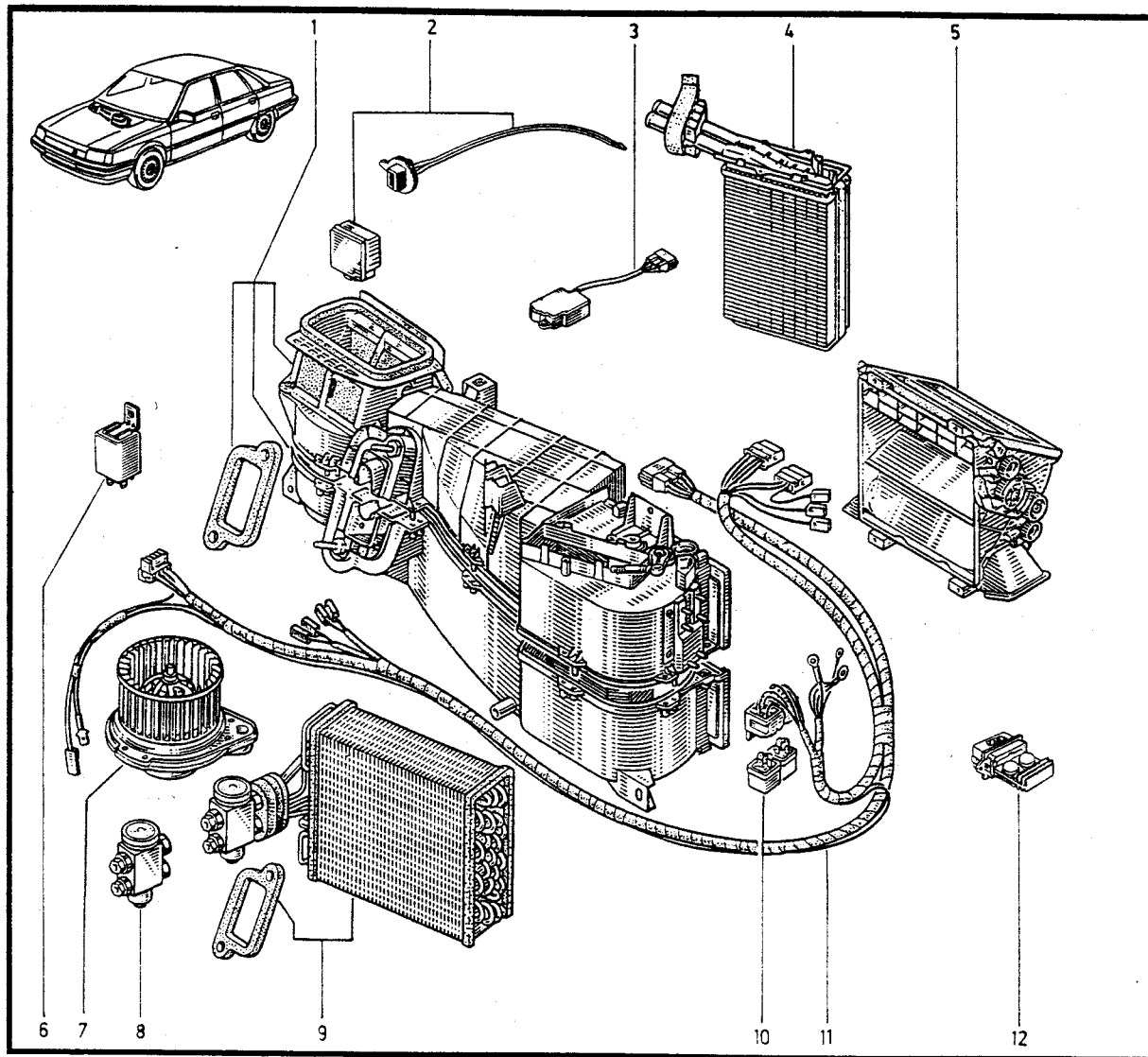

L48S	↔	n°	11818	↔	n°
L488	↔	n°	1	↔	n°
K48S	↔	n°	01947	↔	n°
K488	↔	n°	1	↔	n°
L48Z	↔	n°	1	↔	n°
L48K 208/209	↔	n°	1	↔	n°
L48G 202	↔	n°	1	↔	n°
K48G 202	↔	n°	1	↔	n°
K48X 210	↔	n°	1	↔	n°
K48Y	↔	n°	1	↔	n°
L48Y	↔	n°	1	↔	n°



62.35

P.R. 1233

- 1- 77 02 205 165
- 2- 77 03 077 235
- 3- 77 02 205 166 (a)
- 77 02 216 564 (b)
- 4- 77 02 205 160
- 5- 77 00 695 994
- 6- 77 00 695 993
- 7- 77 00 769 191 †
- 77 02 205 261
- 8- 77 02 205 168
- 9- 77 02 205 167 (a)
- 77 02 216 563 (b)
- 10- 77 05 005 132
- 11- 77 02 206 562
- 12- 77 02 206 801

62.35

P.R. 1233

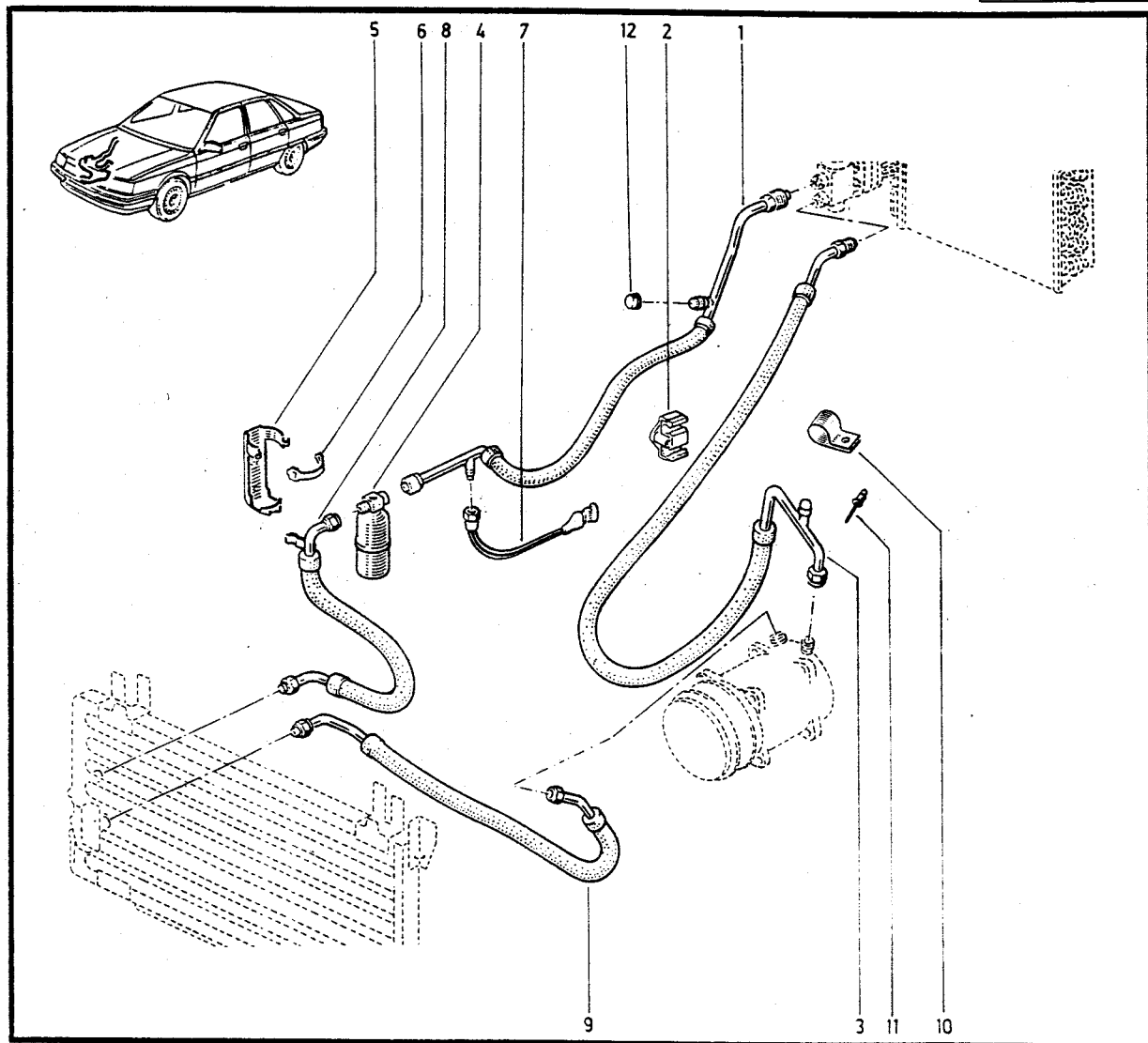
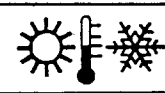

(a)	L48S	↔	n²	1	⇔	n²	09449
	K48S	↔	n²	1	⇔	n²	01207
	L489	↔	n²	1	⇔	n²	02030
	K489	↔	n²	1	⇔	n²	01016

(b)	L48S	↔	n²	09450	⇔	n²
	K48S	↔	n²	01208	⇔	n²
	L489	↔	n²	02031	⇔	n²
	K488	↔	n²	01017	⇔	n²
	L48Z	↔	n²	1	⇔	n²
	L488	↔	n²	1	⇔	n²
	K488	↔	n²	1	⇔	n²

(b)	L48K	↔	n²	1	⇔	n²
	L48G	↔	n²	1	⇔	n²
	K48G	↔	n²	1	⇔	n²
	L48X	↔	n²	1	⇔	n²
	K48X	↔	n²	1	⇔	n²



62.36

12.94 P.R. 1233



62.36

P.R. 1233



- 1 - 77 02 216 671
- 2 - 77 03 077 235
- 3 - 77 02 216 672
- 4 - 77 02 205 160
- 5 - 77 00 695 994
- 6 - 77 00 695 993
- 7 - 77 02 205 261
- 8 - 77 02 205 168
- 9 - 77 02 216 563
- 10 - 77 05 005 132
- 11 - 77 02 206 562
- 12 - 77 02 206 801

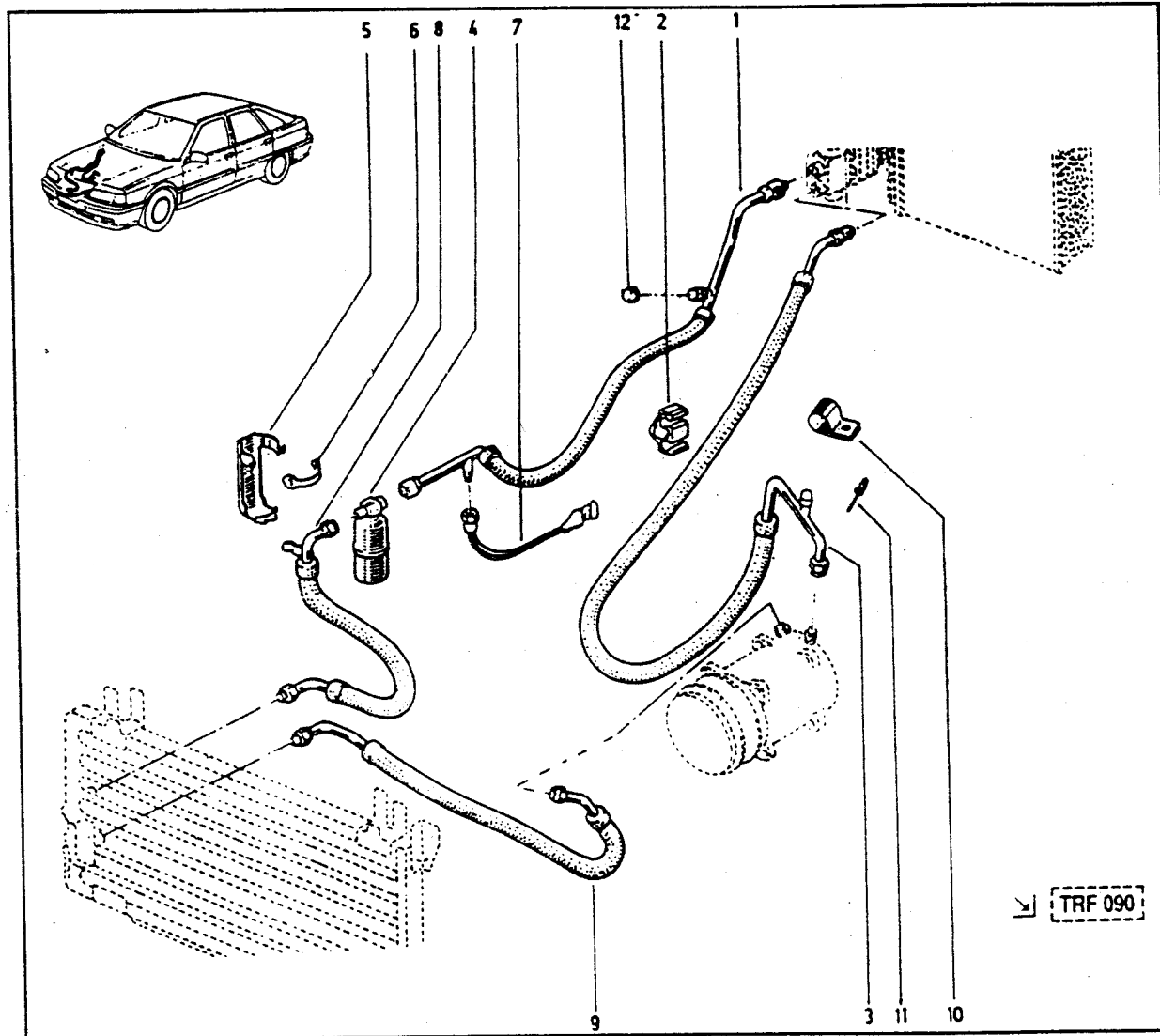

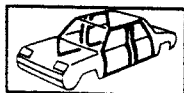

64.01

P.R. 1233

64.01

P.R. 1233

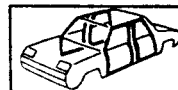

- 1- 77 00 763 490
- 2- 77 00 798 741
- 3- 77 00 763 492
- 4- 77 00 762 875
- 5- 77 00 769 611
- 6- 77 03 081 097
- 7- 77 00 775 106
- 8- 77 03 074 297
- 9- 77 03 074 329
- 10- 77 00 771 519 †
- 77 00 798 996
- 11- 77 00 764 713
- 77 02 206 227
- 12- 77 03 073 212
- 13- 77 00 772 017
- 14- 77 00 772 016
- 15- 77 00 768 054
- 16- 77 03 074 336
- 17- 77 00 780 778
- 18- 77 03 077 249
- 19- 77 00 773 284
- 20- 77 00 788 950
- 21- 77 00 785 318
- 22- 77 02 098 656
- 23- 77 00 774 936
- 24- 77 02 207 316
- 25- 77 00 768 285

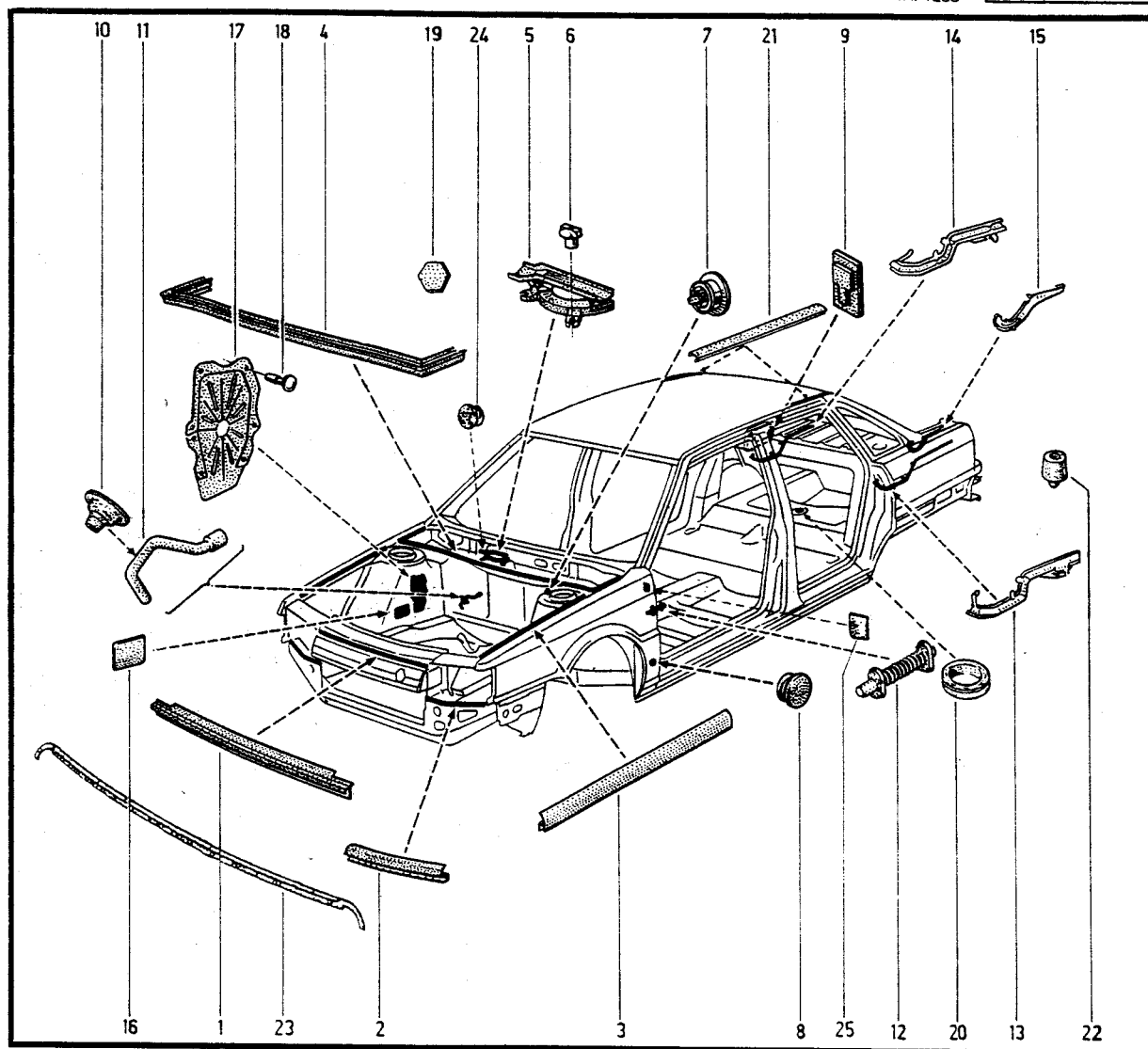

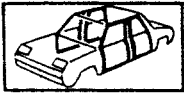

64.01.1

P.R. 1235

64.01.1

P.R. 1233

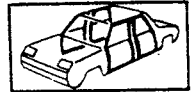

- 1- 77 00 774 848
- 2- 77 00 768 741
- 3- 77 00 763 492
- 4- 77 00 762 875
- 5- 77 00 769 611
- 6- 77 03 081 097
- 7- 77 00 775 106
- 8- 77 03 074 297
- 9- 77 03 074 329
- 10- 77 00 771 519 †
- 77 00 798 996
- 11- 77 00 764 713
- 77 02 206 227
- 12- 77 03 073 212
- 13- 77 03 074 336
- 14- 77 03 073 213
- 15- 77 00 780 778
- 16- 77 03 077 249
- 17- 77 03 074 175
- 18- 77 00 795 485
- 19- 77 03 074 338
- 20- 77 00 786 289
- 21- 77 00 627 368
- 22- 77 00 784 643
- 23- 77 03 072 050
- 24- 77 02 098 694
- 25- 77 02 098 693
- 26- 77 02 098 827
- 27- 77 03 074 424
- 28- 77 02 207 316

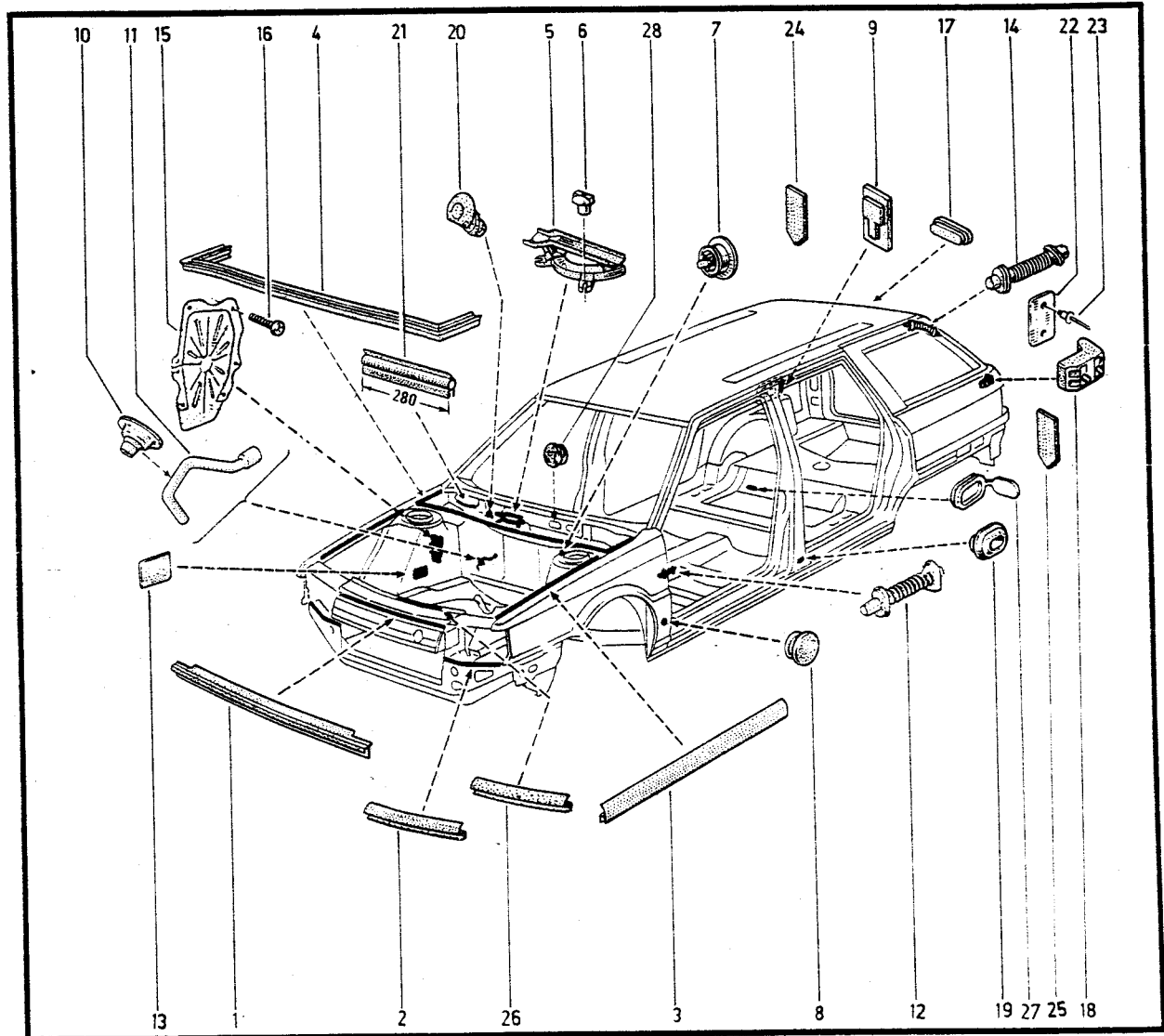

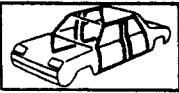

64.02
P.R. 1233

64.02
P.R. 1233



- 1- 77 00 763 494 +
- 2- 77 00 766 826
- 3- 77 03 074 316
- 4- 77 03 074 339
- 5- 77 03 074 335
- 6- 77 03 073 217
- 7- 77 00 766 826
- 8- 77 00 777 440 +
- 77 02 098 830 +
- 77 00 827 978 +
- 77 02 098 831
- 9- 77 00 780 389

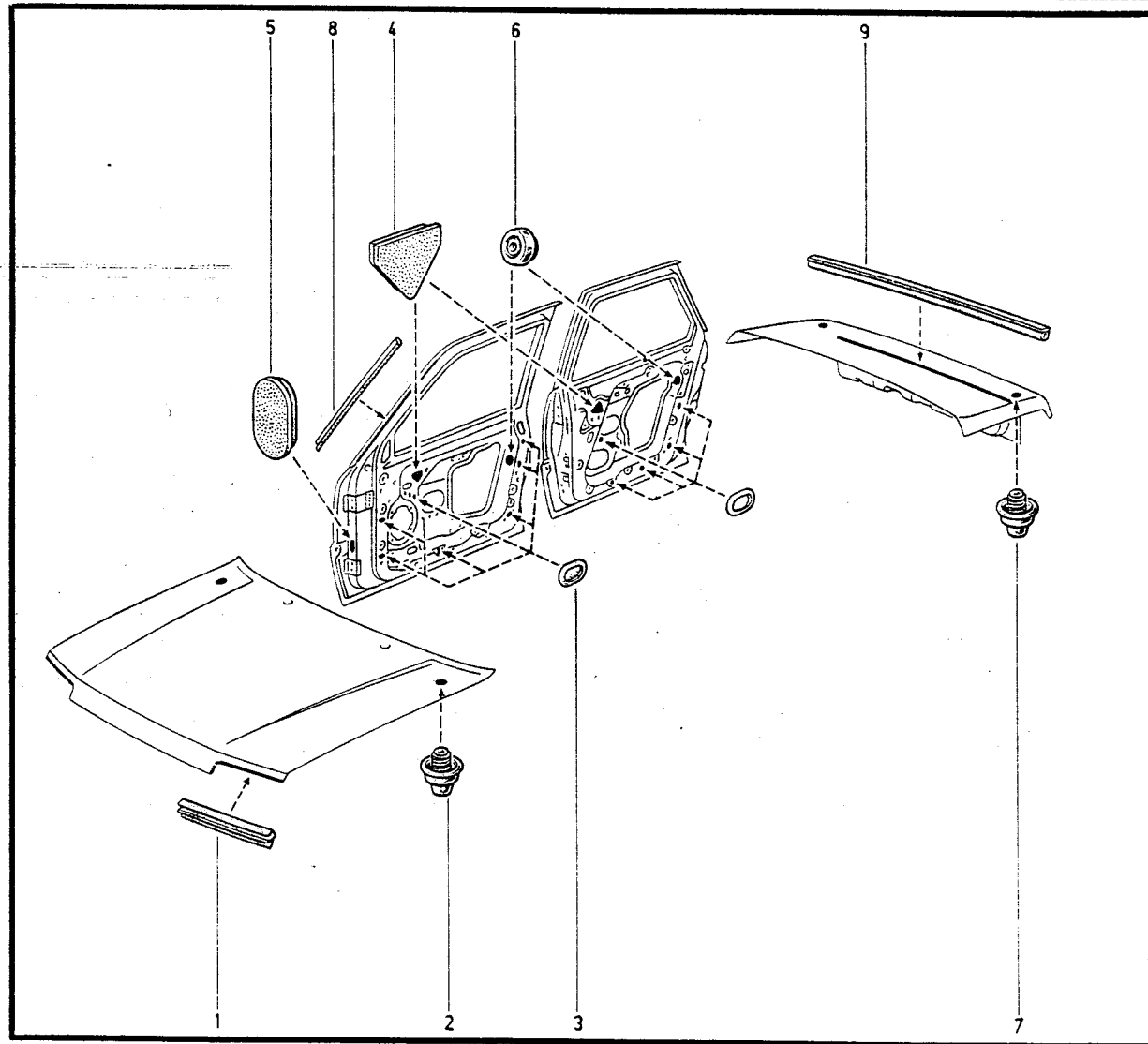

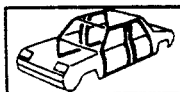

64.02.1

P.R. 1233

64.02.1

P.R. 1233

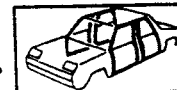

- 1- 77 00 766 826
- 2- 77 03 074 316
- 3- 77 03 074 339
- 4- 77 03 074 335
- 5- 77 03 073 217
- 6- 77 00 777 440 †
- 77 02 098 830 †
- 77 00 827 978 †
- 77 02 098 831
- 7- 77 04 000 302
- 8- 77 03 074 073

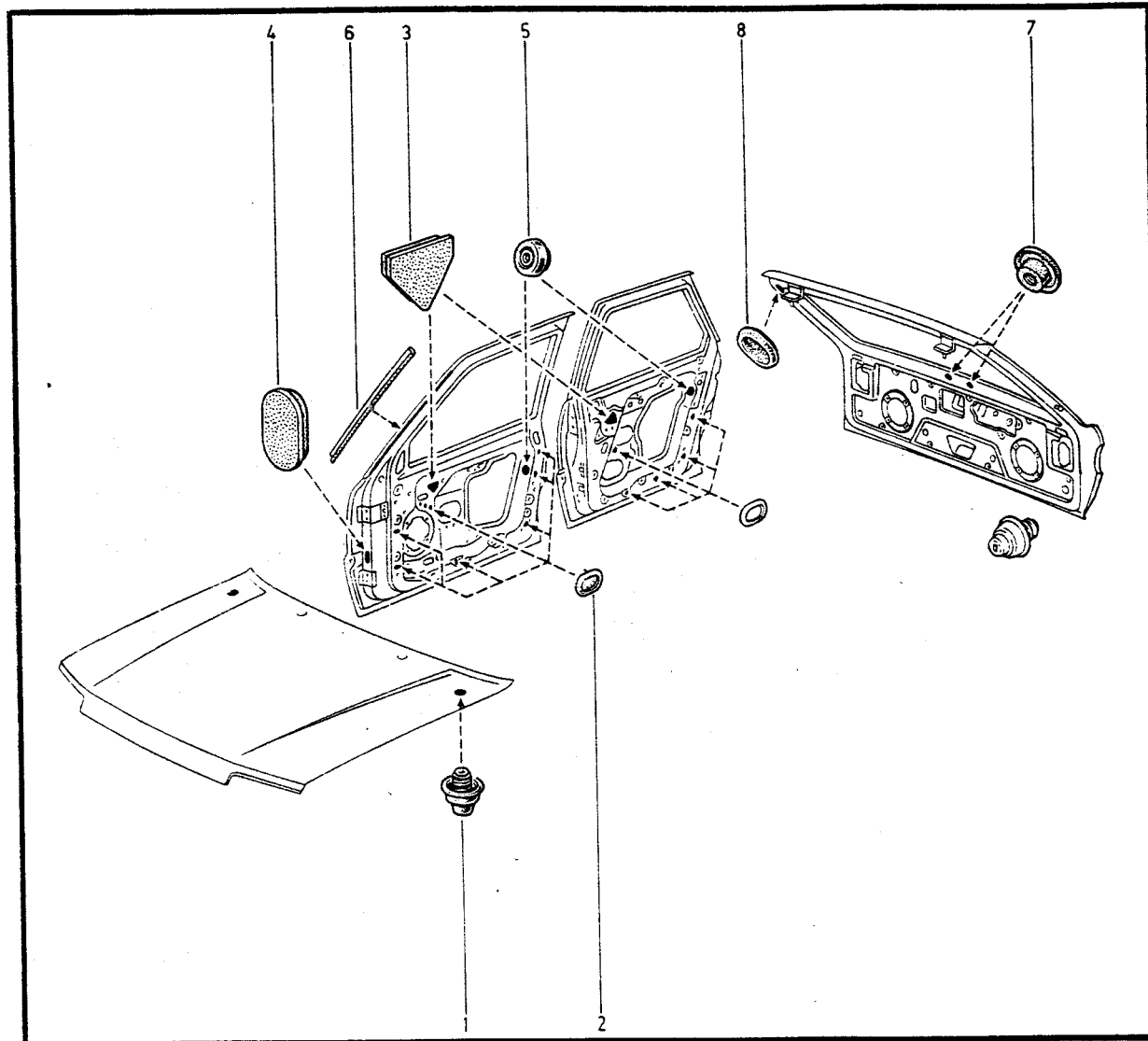

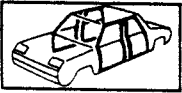

65.01

P.R. 1233

65.01

P.R. 1233

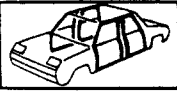

- 1- 77 00 781 425 +
- 77 00 777 518
- 2- 77 00 702 427 +
- 77 00 793 412
- 3- 77 00 781 426 +
- 77 00 777 517
- 4- 77 00 781 428
- 5- 77 00 762 007
- 6- 77 00 767 533
- 7- 77 00 784 717
- 8- 77 00 784 718
- 9- 77 00 781 432

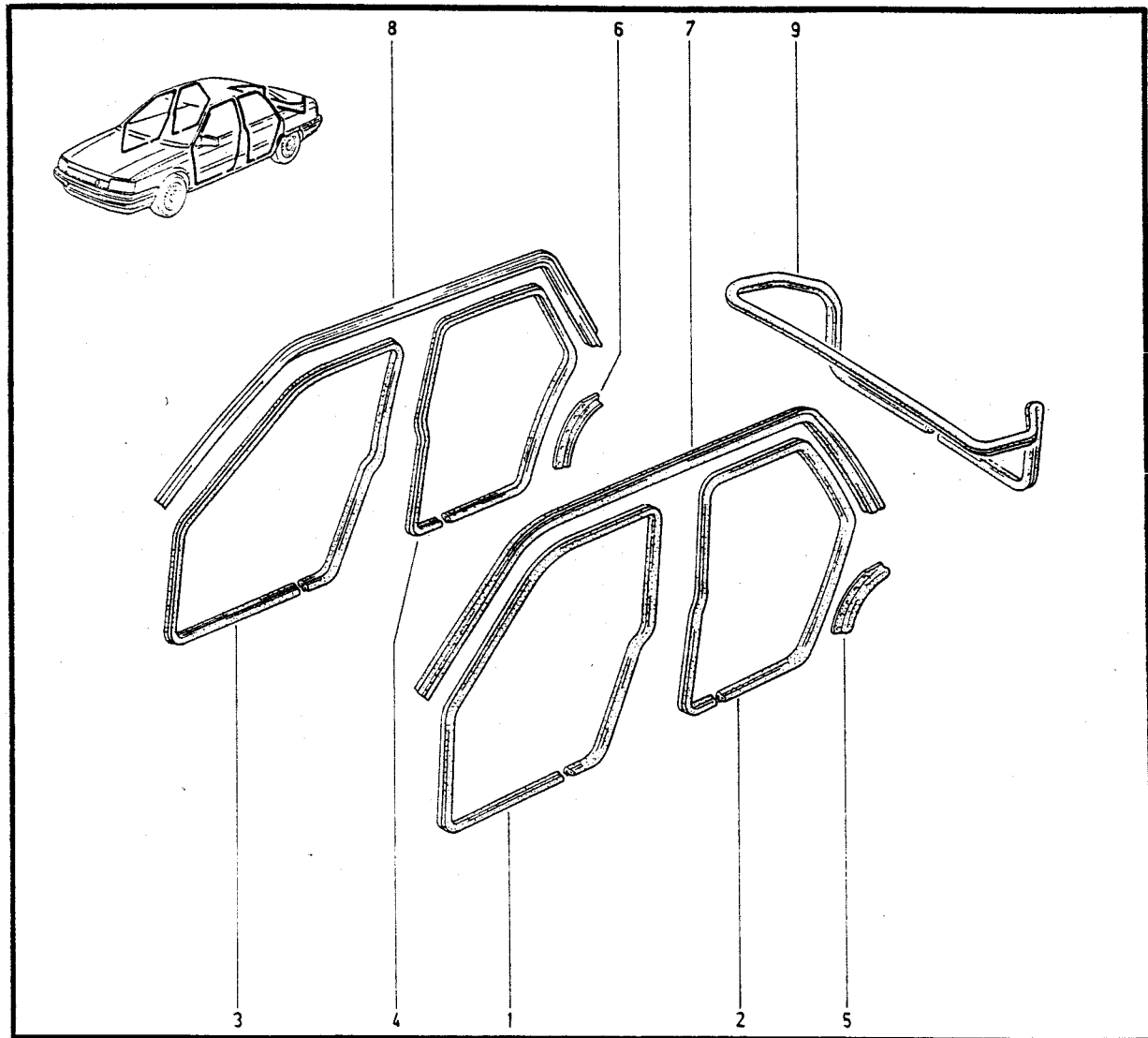

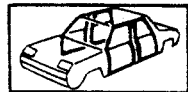

65.05

P.R. 1233

- 1- 77 00 781 425 †
- 77 00 777 518
- 2- 77 00 802 402
- 3- 77 00 781 426 †
- 77 00 777 517
- 4- 77 00 802 402
- 5- 77 00 762 007
- 6- 77 00 767 533
- 7- 77 00 790 148
- 8- 77 00 790 149
- 9- 77 00 781 431

65.05

P.R. 1233

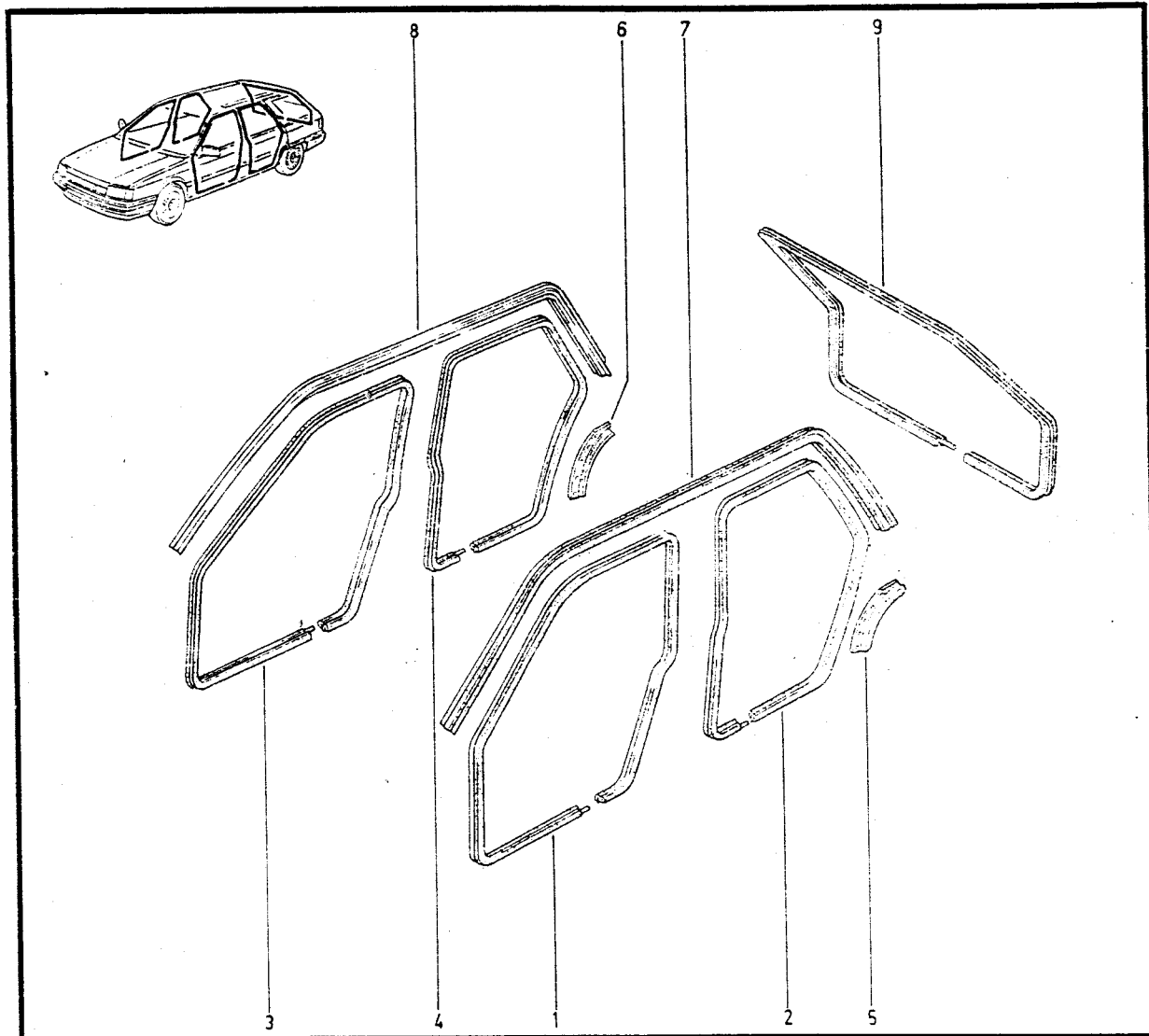
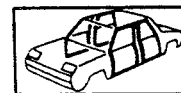

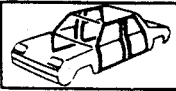

66.01

P.R. 1233

66.01

P.R. 1233



- 1-77 00 768 901
- 2-77 00 771 174
- 3-77 00 767 925
- 4-77 05 099 009
- 5-77 01 202 745
- 6-77 00 773 126
- 7-77 00 761 991 +
- 77 00 804 816
- 8-77 00 761 994
- 9-77 00 761 992 +
- 77 00 804 818
- 10-77 00 761 997
- 11-77 00 762 000
- 12-77 00 763 224
- 13-77 00 762 003 +
- 77 00 804 819
- 14-77 00 762 004 +
- 77 00 804 821
- 15-77 00 763 104 +
- 77 00 782 587
- 16-77 00 761 995
- 17-77 00 772 392
- 18-77 01 202 559
- 19-77 00 768 941
- 20-77 01 202 575
- 21-77 00 780 488

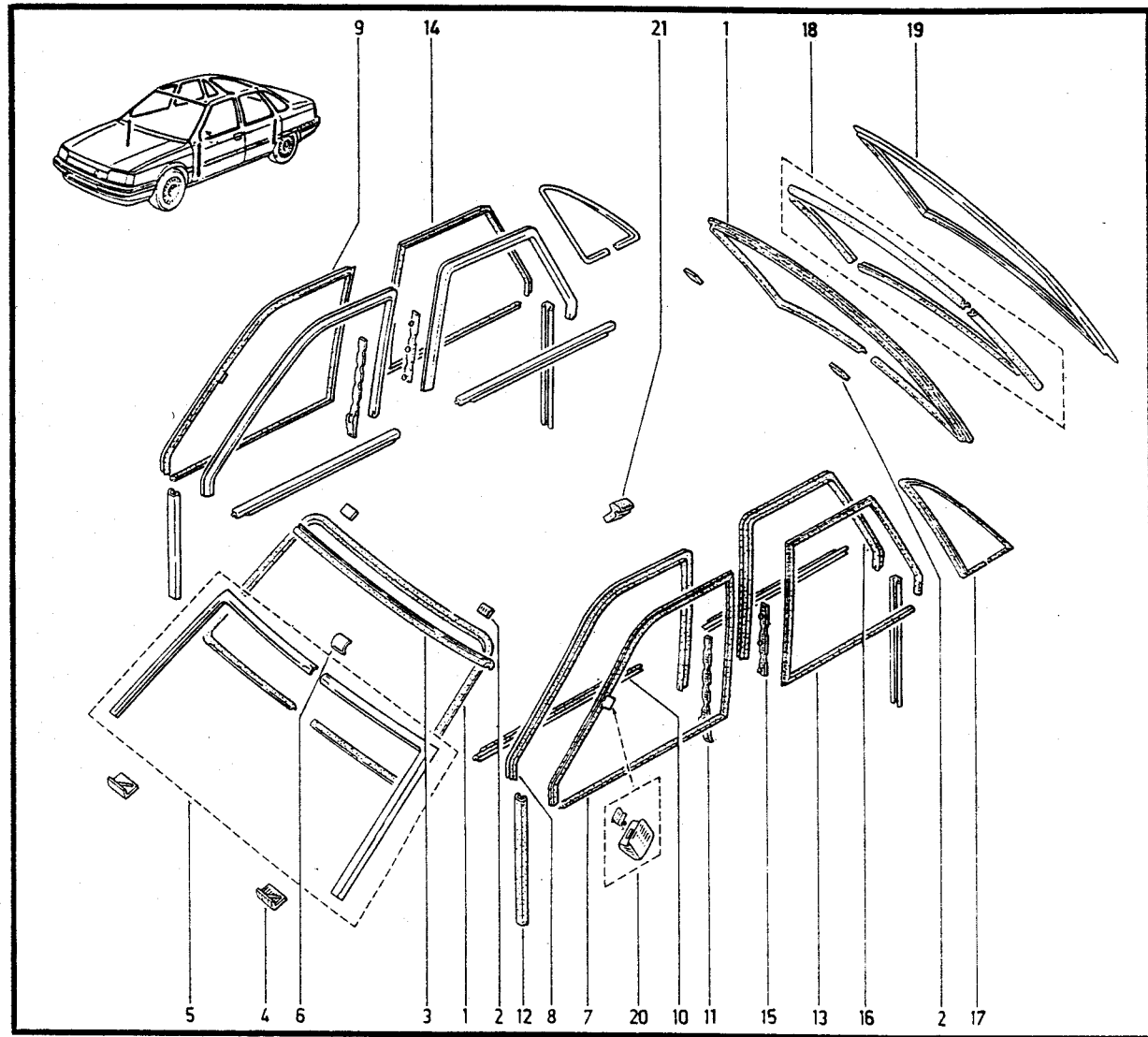

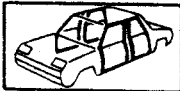

66.03

P.R. 1233

66.03

P.R. 1233

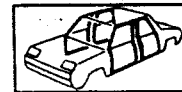

- 1- 77 00 768 901
- 2- 77 00 767 925
- 3- 77 00 771 174
- 4- 77 05 099 009
- 5- 77 00 761 991 †
- 77 00 804 816
- 6- 77 01 202 575
- 7- 77 00 761 994
- 8- 77 00 780 488 †
- 77 00 816 146
- 9- 77 00 770 025 †
- 77 00 821 175
- 10- 77 00 763 224
- 11- 77 00 762 000
- 12- 77 00 761 992 †
- 77 00 804 818
- 13- 77 00 767 605
- 14- 77 00 761 994
- 15- 77 00 763 104 †
- 77 00 782 587
- 16- 77 00 767 606 †
- 77 00 804 824
- 17- 77 01 202 698
- 18- 77 00 770 021
- 19- 77 00 770 029

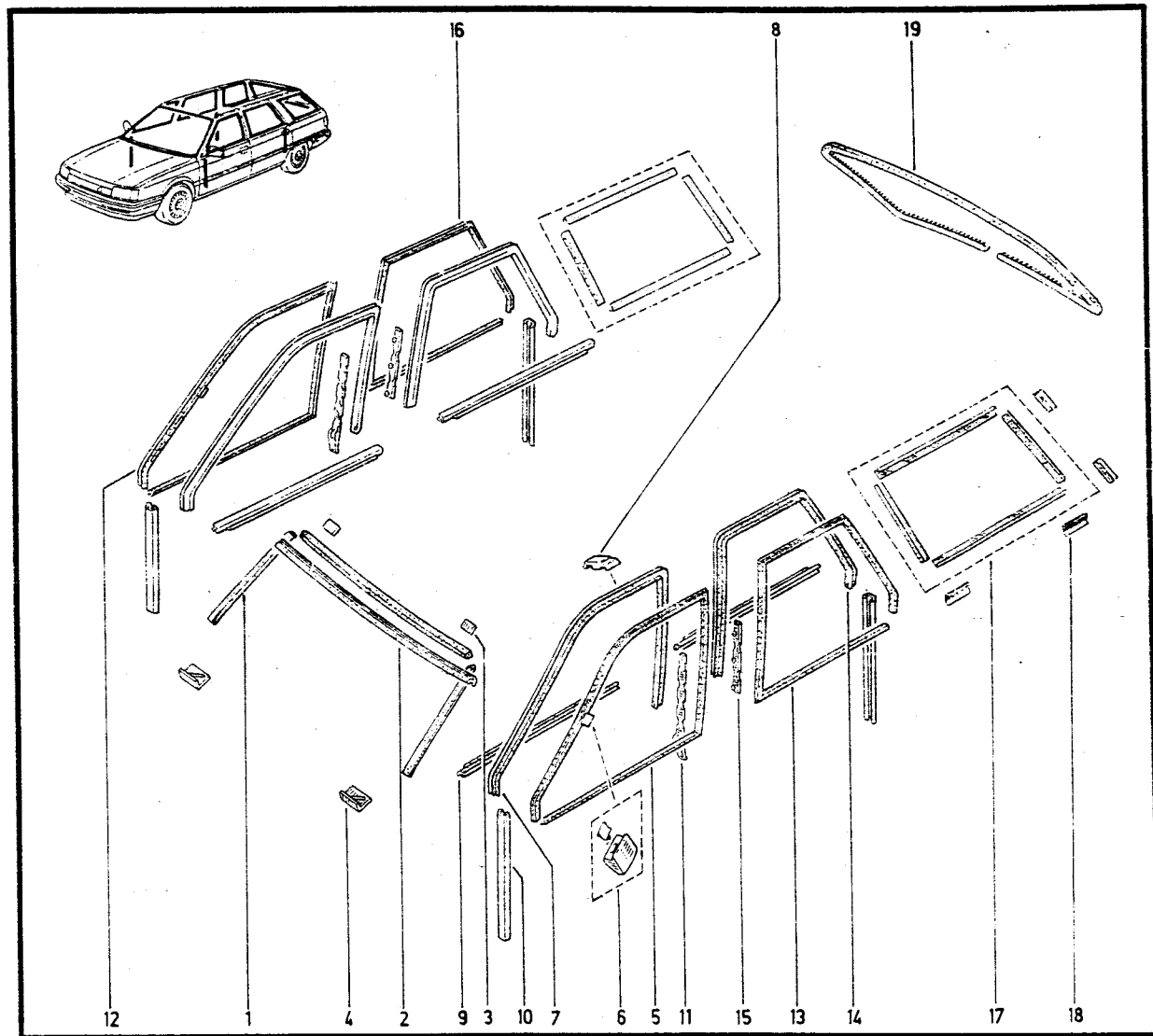



66.05

P.R. 1233

- 1 - 77 01 202 745
- 2 - 77 00 773 126
- 3 - 77 01 202 950
- 4 - 77 01 202 951
- 5 - 77 01 202 701
- 6 - 77 03 072 263
- 77 03 072 231

66.05

P.R. 1233

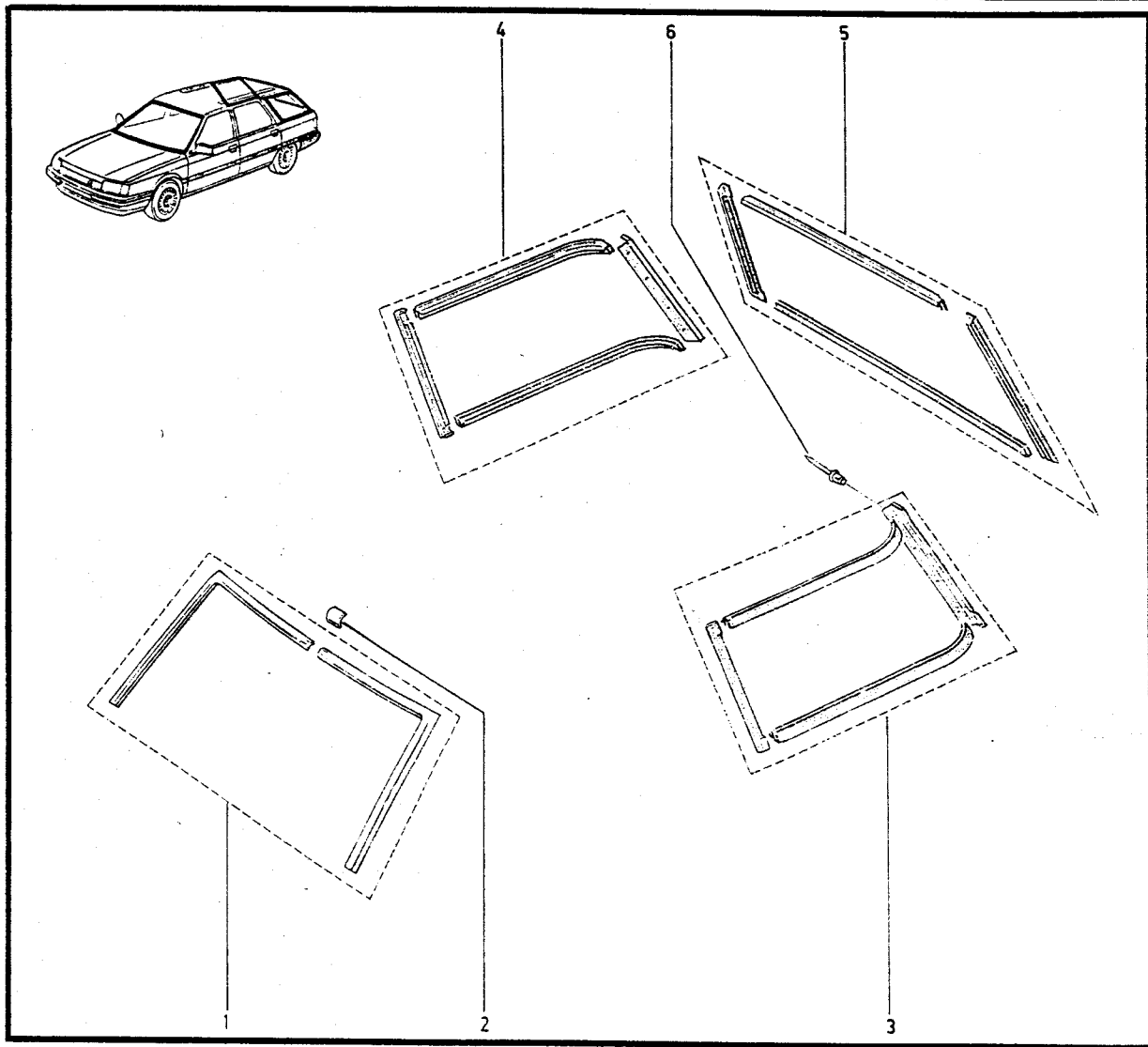
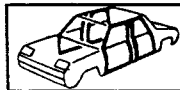



68.01

P.R. 1233

- 1- 77 00 766 569 †
- 77 02 219 030
- 2- 77 03 081 054
- 3- 77 00 765 686 †
- 77 02 215 318 †
- 77 02 215 344 †
- 77 02 219 031
- 4- 77 00 765 685 †
- 77 02 219 032
- 5- 77 00 766 271 †
- 6- 77 03 077 117
- 7- 77 00 772 376
- 8- 77 00 772 368
- 9- 77 03 076 126

68.01

P.R. 1233

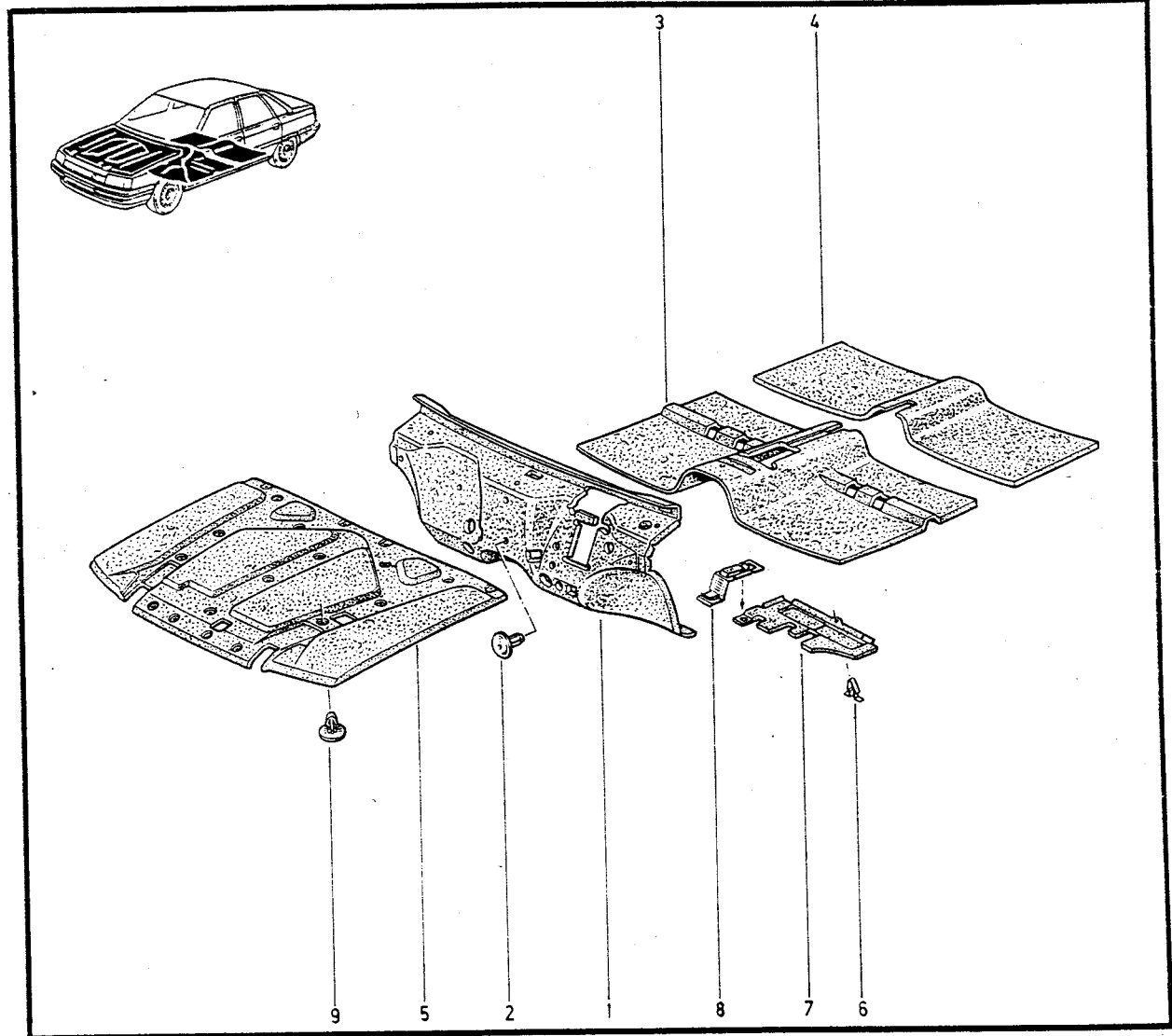



69.01

P.R. 1233

- 1- 77 00 788 577 (2) (1) (a)
- 77 02 212 160 (2) (2) (b)
- 77 02 220 177 (2) (3) (c)
- 2- 77 03 081 096
- 3- 77 03 081 097
- 4- 77 03 081 054
- 5- 77 02 220 176

69.01

P.R. 1233

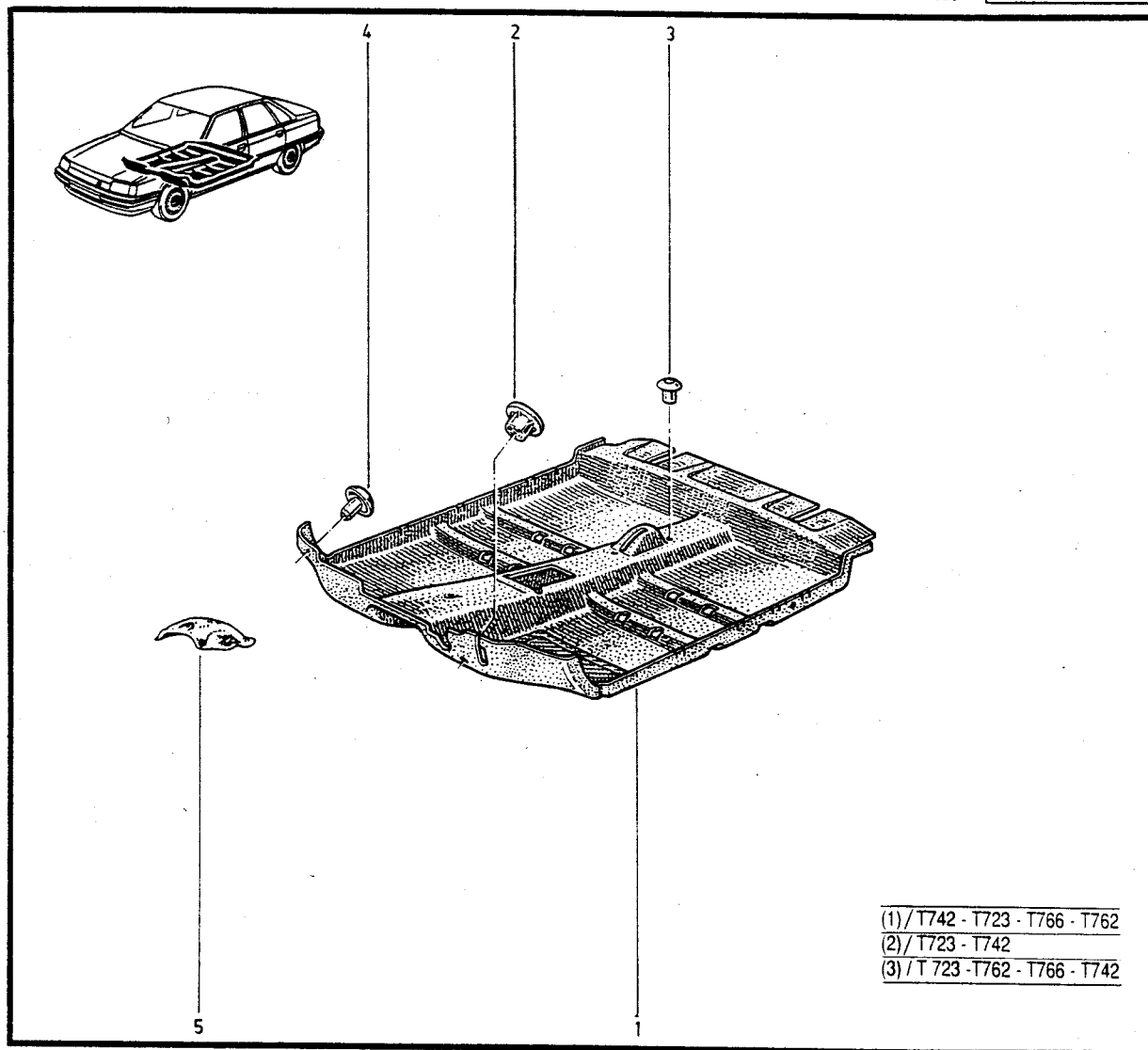

- (a) / L48S 090-091
- / L48X 208
- / L48Z 091
- / L48Y 091
- (b) / L48G 202
- / L488 089
- (c) / L48K 209
- / L48Z 095

- (1) / T742 - T723 - T766 - T762
- (2) / T723 - T742
- (3) / T 723 - T762 - T766 - T742



69.05

P.R. 1233

- 1- 77 02 213 445 [22] (1) (a)
- 77 02 208 901 [22] (2) (b)
- 77 02 215 359 [22] (3) (c) ✓
- 2- 77 03 081 096
- 3- 77 03 081 097
- 4- 77 03 081 054

69.05

P.R. 1233

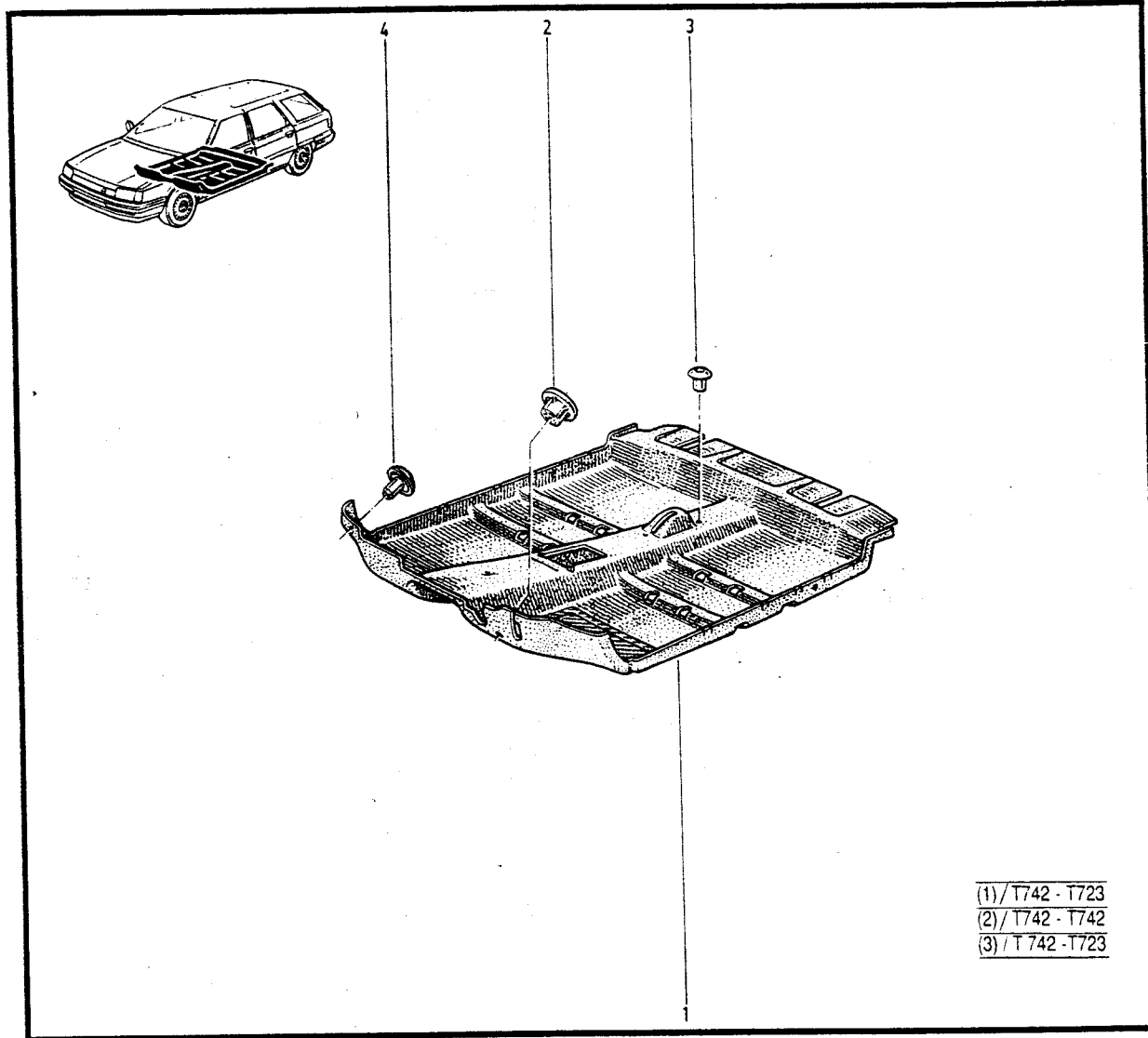

(1) / T742 - T723
(2) / T742 - T742
(3) / T 742 - T723

- (a) / K48G 202
K487 089
K488 089
- (b) / K48S 090
K48Y 090
- (c) / K48S 092
K48X 210
K48Y 092



71.01
P.R. 1233

71.01
P.R. 1233



- 1-77 00 765 682
- 2-77 00 765 000
- 3-77 00 765 576
- 4-77 00 765 138
- 5-77 00 764 451
- 6-77 00 765 683
- 7-77 00 765 001
- 8-77 00 765 577
- 9-77 00 765 139
- 10-77 00 764 452
- 11-77 00 764 262
- 12-77 03 077 183
- 12-77 03 074 022
- 14-77 03 080 060
- 15-77 00 764 385
- 16-77 03 081 019
- 17-77 03 016 401
- 18-77 03 081 026
- 19-77 00 774 858
- 20-77 00 776 280

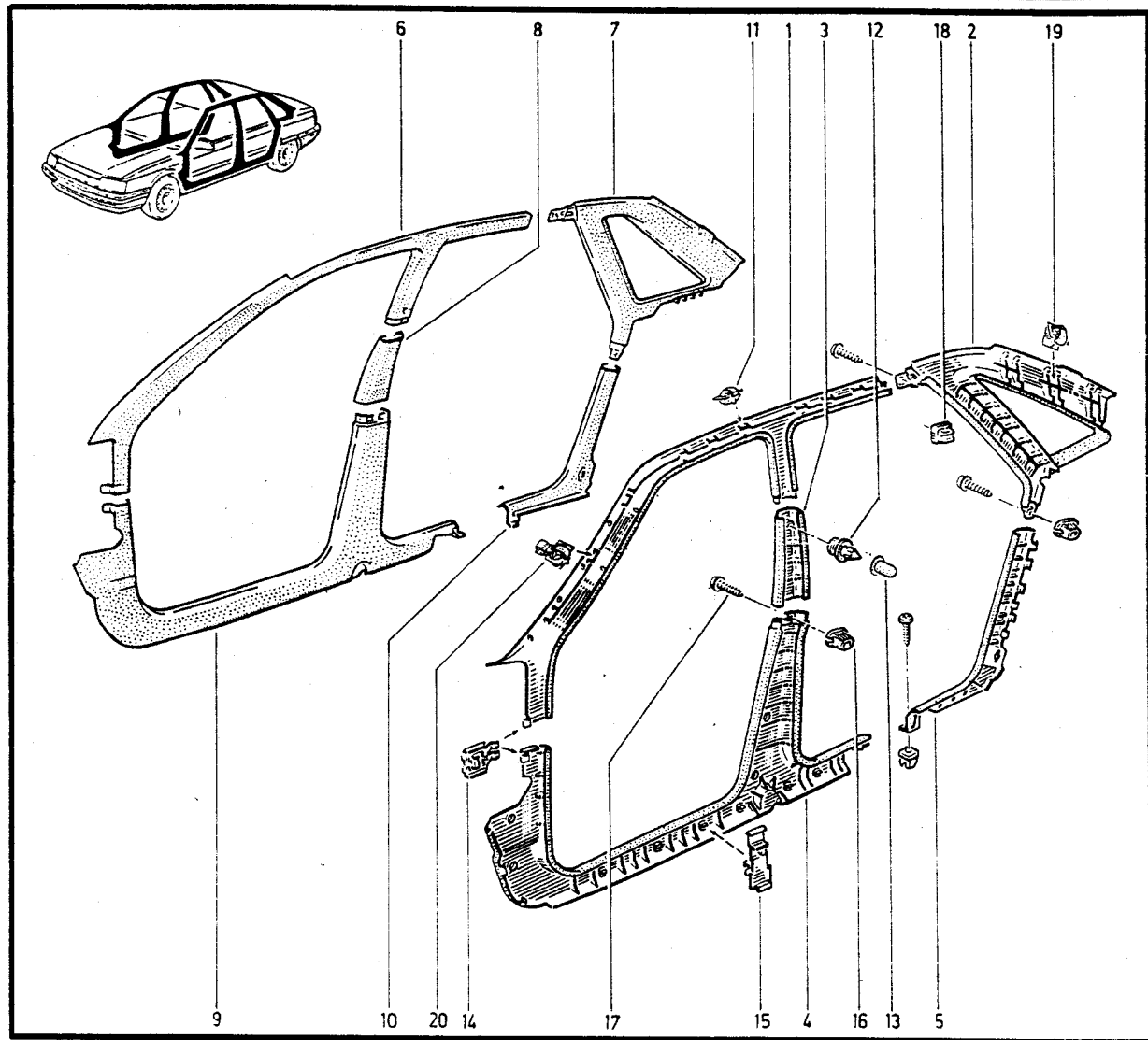



71.03

P.R. 1233

71.03

P.R. 1233



- 1- 77 00 769 160 [22]
- 77 02 211 543 [22] (b)
- 77 02 211 501 [22] (a)
- 2- 77 02 208 895 [22]
- 3- 77 00 765 576 [22]
- 4- 77 00 765 138 [22]
- 5- 77 00 769 161 [22]
- 77 02 211 544 [22] (b)
- 77 02 211 502 [22] (a)
- 6- 77 02 208 896 [22]
- 7- 77 00 765 577 [22]
- 8- 77 00 765 139 [22]
- 9- 77 00 764 262
- 10- 77 03 077 183
- 11- 77 03 074 022
- 12- 77 03 080 060
- 13- 77 00 764 385
- 14- 77 03 081 019
- 15- 77 03 016 401
- 16- 77 03 081 026
- 17- 77 00 776 230
- 18- 77 03 084 363 [22]
- 19- 77 00 774 858

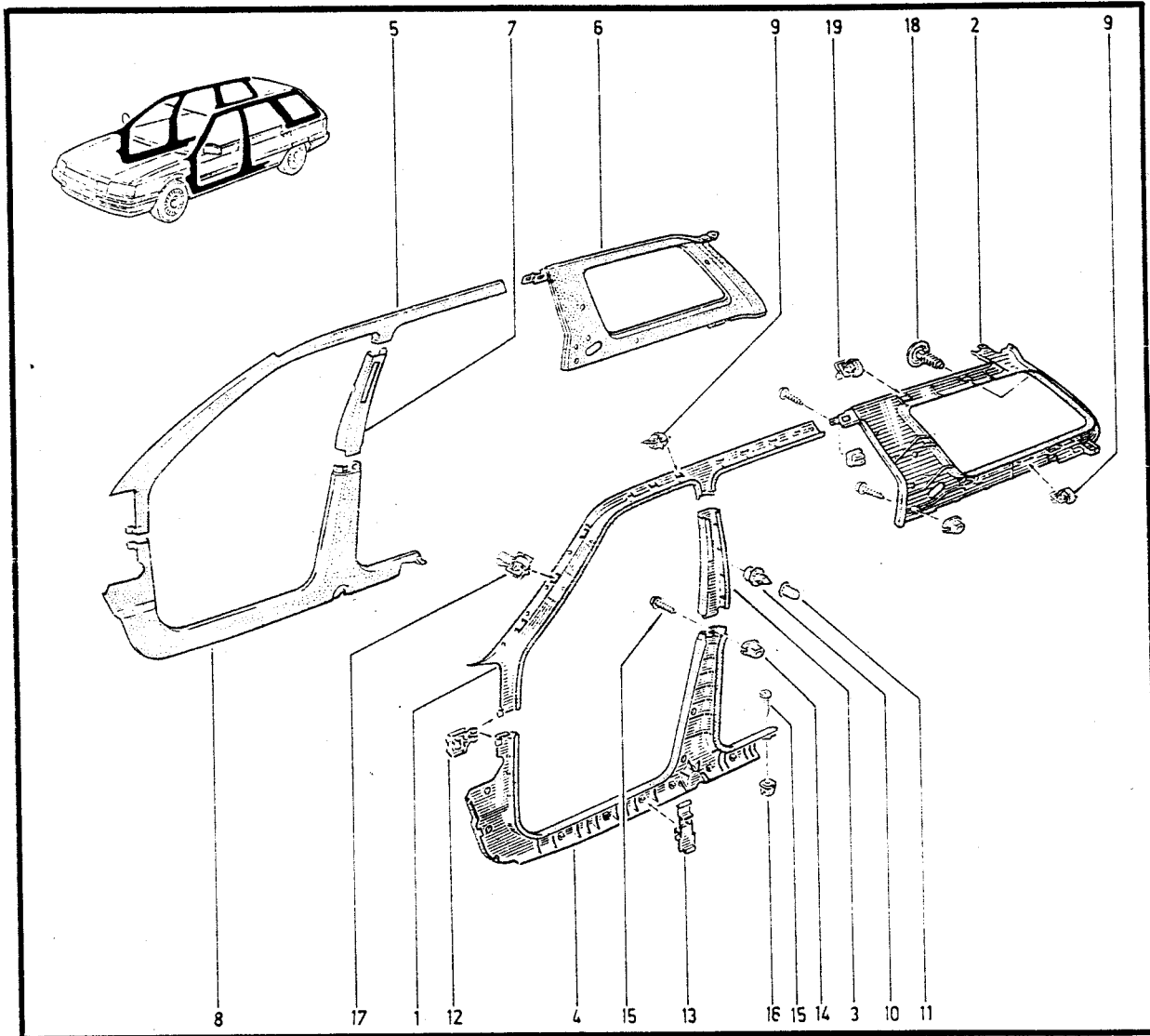

(a)

(b)

K488

K489



71.05

P.R. 1233

71.05

P.R. 1233



- 1- 77 00 783 499 (a) †
- 77 02 215 825 (b)
- 77 02 215 824 (c)
- 2- 77 00 792 082 (a) †
- 77 02 215 826 (b) (f)
- 3- 77 02 792 081
- 77 02 208 812 (a) †
- 77 02 215 829 (b)
- 77 02 220 158 (f)
- 4- 77 00 768 263 (d)
- 77 00 793 002 (b) (c) (e)
- 5- 77 03 077 068
- 6- 77 03 016 401
- 7- 77 03 081 019
- 8- 77 00 775 921
- 9- 77 03 077 255
- 77 03 077 244

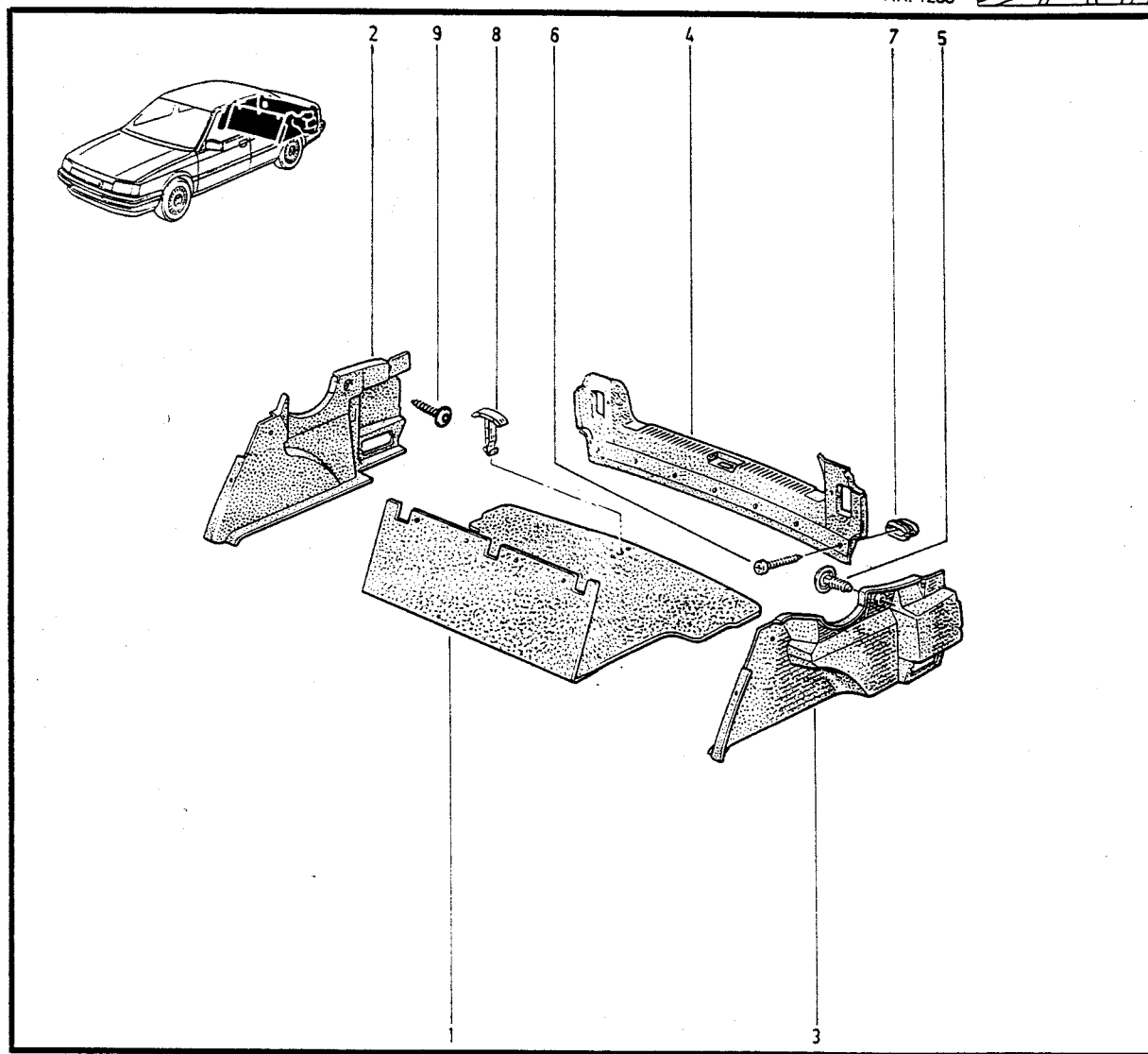

(a)	L488		n ²	1	⇔	n ²	2
	L489		n ²	1	⇔	n ²	3193
	L48S		n ²	1	⇔	n ²	11102
(b)	L48S		n ²	11103	⇔	n ²
	L48Z		n ²	1	⇔	n ²
	L48Y		n ²	1	⇔	n ²
(c)	L488		n ²	3	⇔	n ²
	L489		n ²	3194	⇔	n ²
(d)	L48S		n ²	1	⇔	n ²	06086
(e)	L48S		n ²	06087	⇔	n ²

(f)	L48K 209 - 208
	L48S 208
	L48X 208



71.08

P.R. 1233

71.08

P.R. 1233



- 1- 77 02 220 160 [22]
- 77 00 788 862 [22] ✓
- 2- 77 02 220 161 ✓
- 77 02 220 162
- 3- 77 00 771 291 [22]
- 4- 77 00 768 857 [22]
- 5- 77 00 771 288 [22]
- 6- 77 00 768 855 [22]
- 7- 77 02 210 851 [22]
- 8- 77 00 772 658 [22]
- 9- 77 00 772 657 [22]
- 10- 77 03 077 250
- 11- 77 01 202 714
- 12- 77 03 081 019
- 13- 77 03 016 401
- 14- 77 00 763 428
- 15- 77 00 711 709
- 16- 77 00 782 775 [22]
- 17- 77 03 016 407
- 18- 77 03 046 093
- 19- 77 00 773 792
- 20- 77 03 077 090
- 21- 77 02 211 062

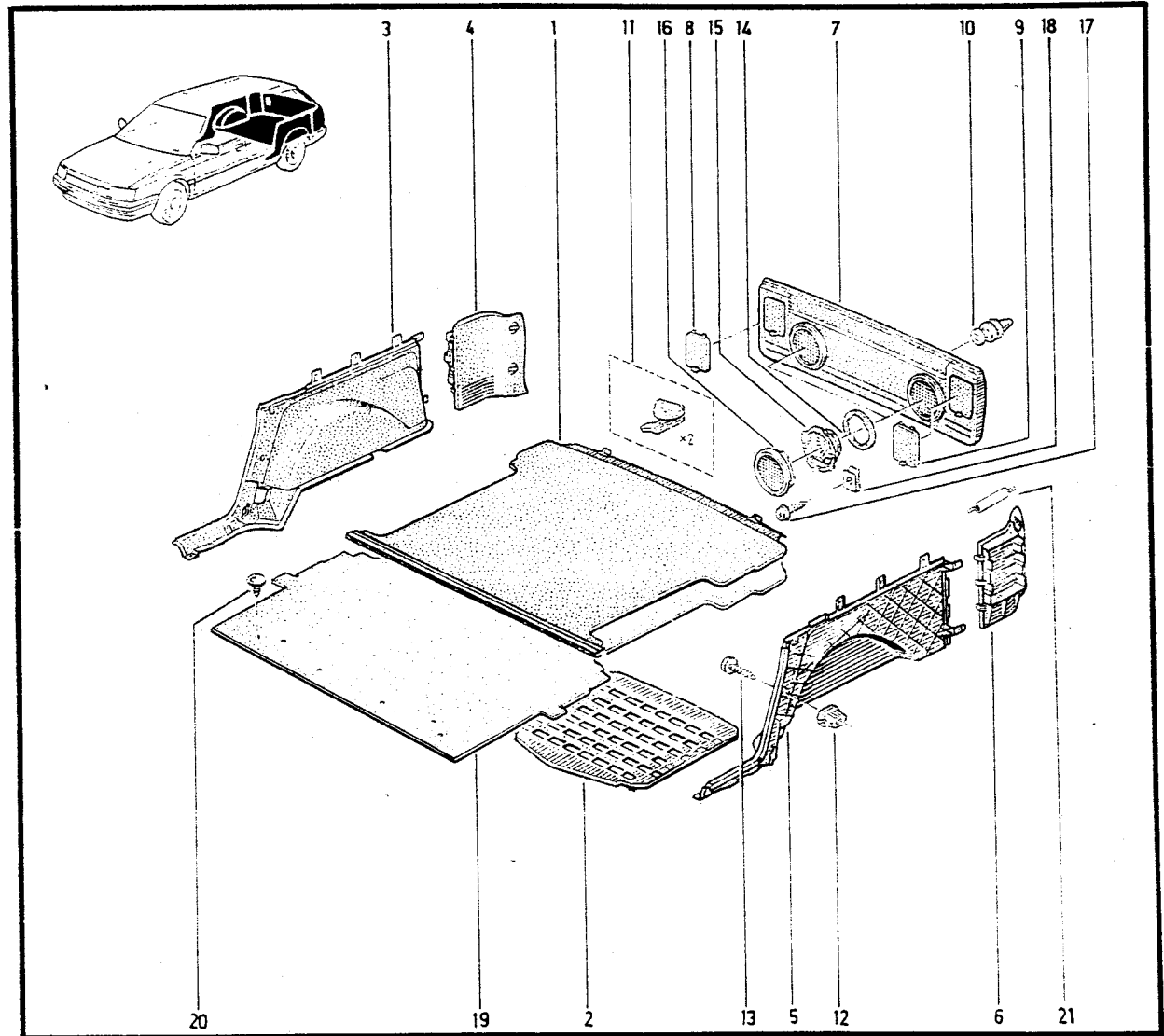

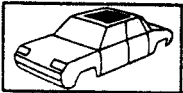

71.10

P.R. 1233

- 1- 77 00 765 251 [22]
- 2- 77 00 765 307
- 3- 77 00 766 348 [22]
- 4- 77 00 765 551 [22]
- 5- 77 00 765 553 [22]
- 6- 77 03 081 026
- 7- 77 03 016 401

71.10

P.R. 1233

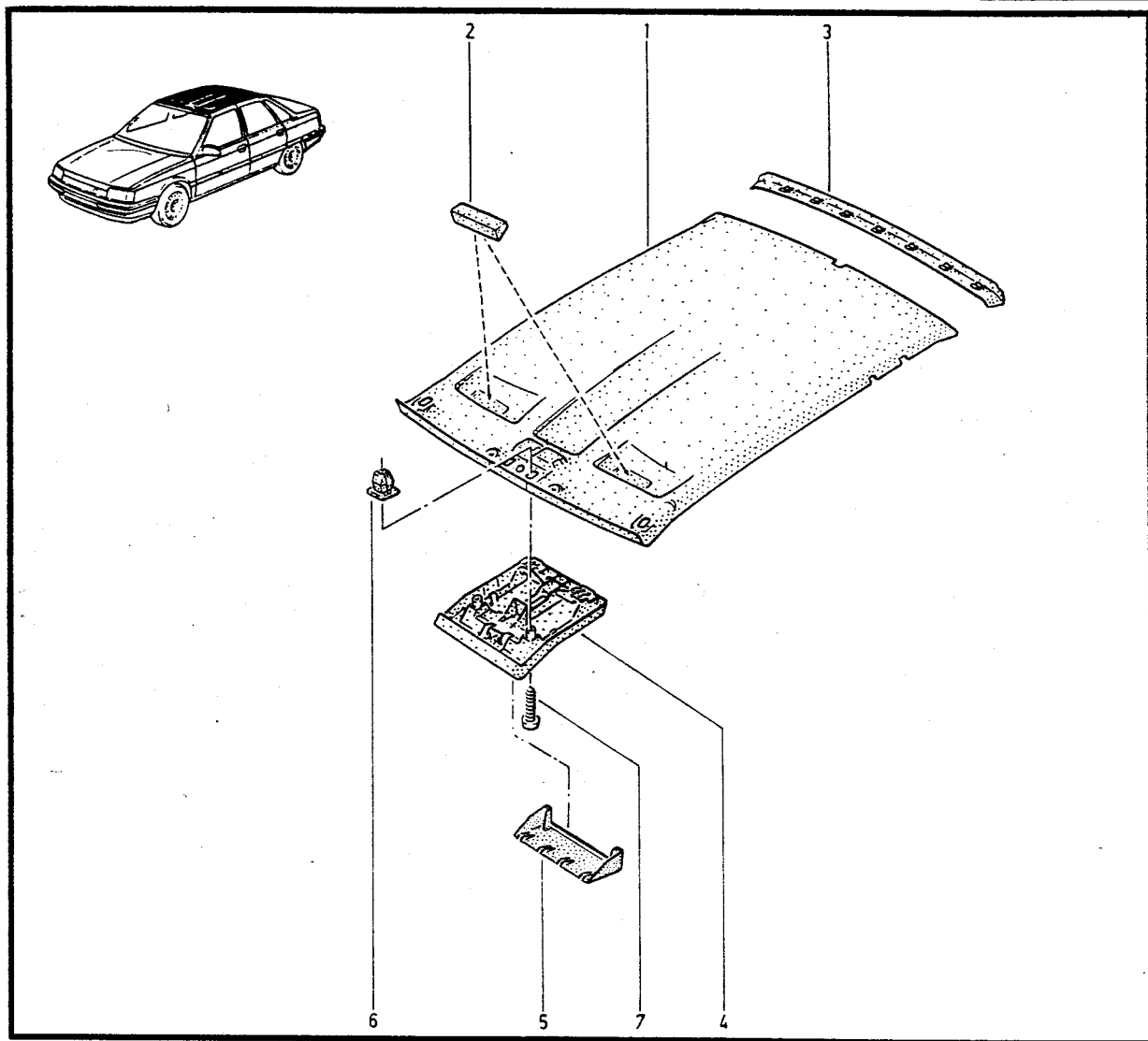
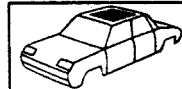

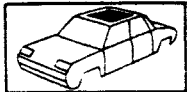

71.13

P.R. 1233

- 1-77 00 767 948 [N]
- 2-77 00 765 307
- 3-77 00 767 243 [N]
- 4-77 00 765 551 [N]
- 5-77 03 077 222
- 6-77 00 765 553 [N]
- 7-77 03 081 026
- 8-77 03 016 401

71.13

P.R. 1233

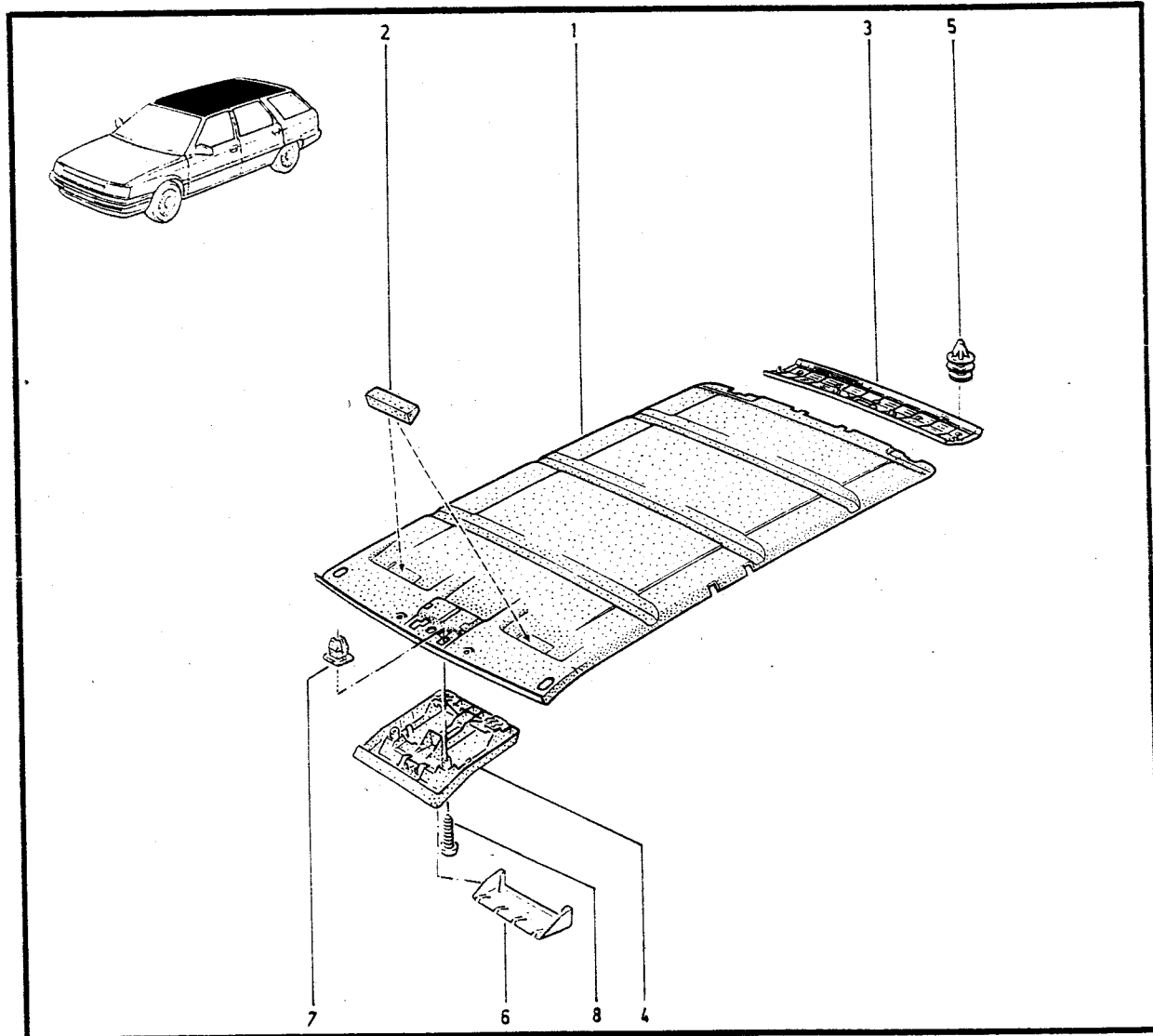

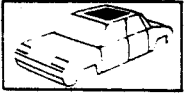

71.15
P.R. 1233

- 1-77 00 768 051
- 2-77 00 768 492
- 3-77 00 766 348
- 4-77 00 765 552
- 5-77 00 765 553
- 6-77 00 769 246
- 7-77 03 081 026
- 8-77 03 016 401

71.15
P.R. 1233

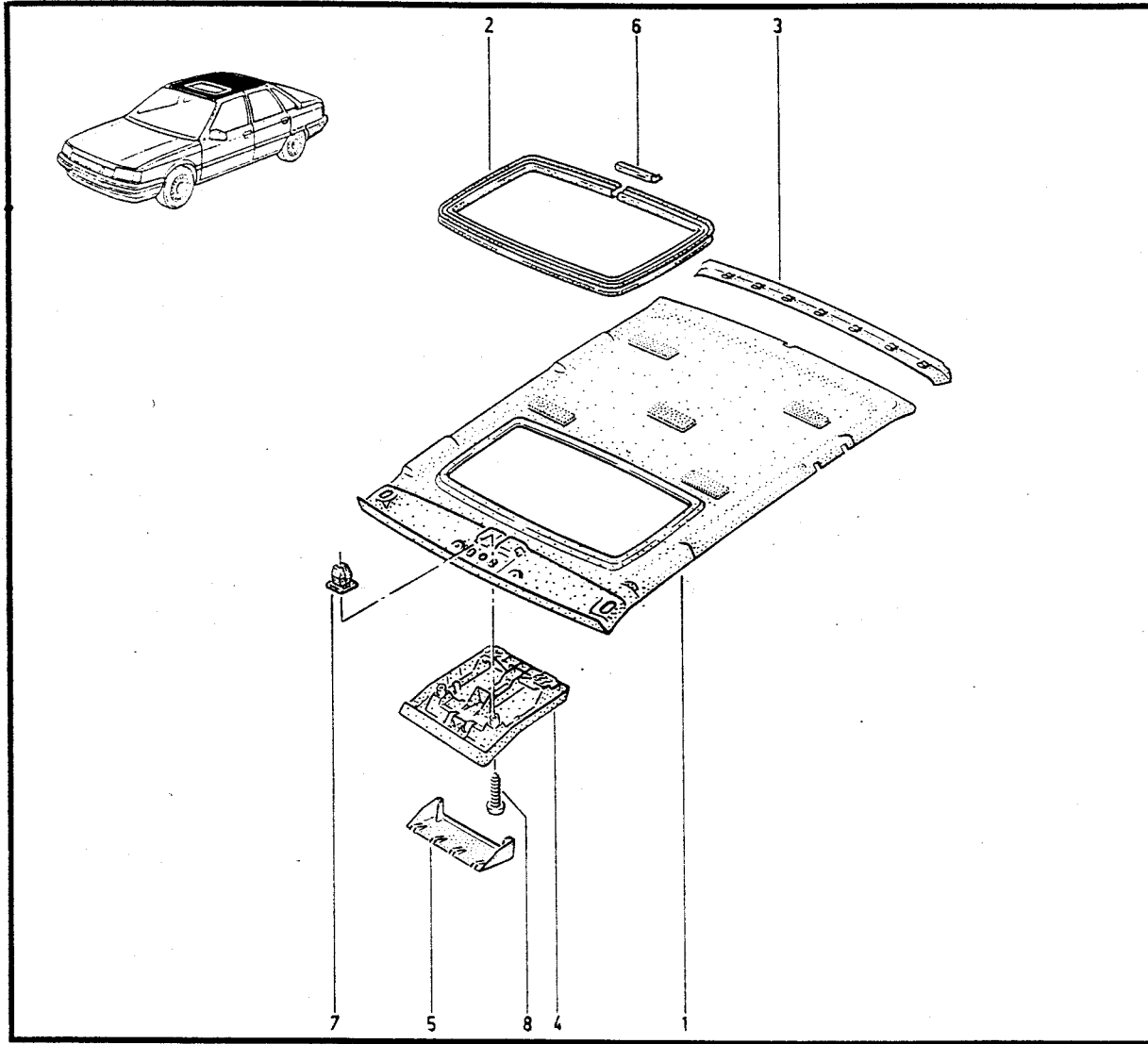

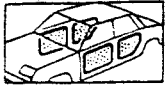

72.01
P.R. 1233

- 1- 77 02 220 339 (22)
- 2- 77 02 220 347 (22) (a)
- 77 02 220 341 (22) (b)
- 77 02 220 345 (22) (c)
- 77 02 220 343 (22) (d)
- 3- 77 02 220 338 (22)
- 4- 77 02 220 346 (22) (a)
- 77 02 220 340 (22) (b)
- 77 02 220 344 (22) (c)
- 77 02 220 342 (22) (d)
- 5- 77 00 752 855
- 6- 77 03 077 183
- 7- 77 03 074 022

72.01
P.R. 1233

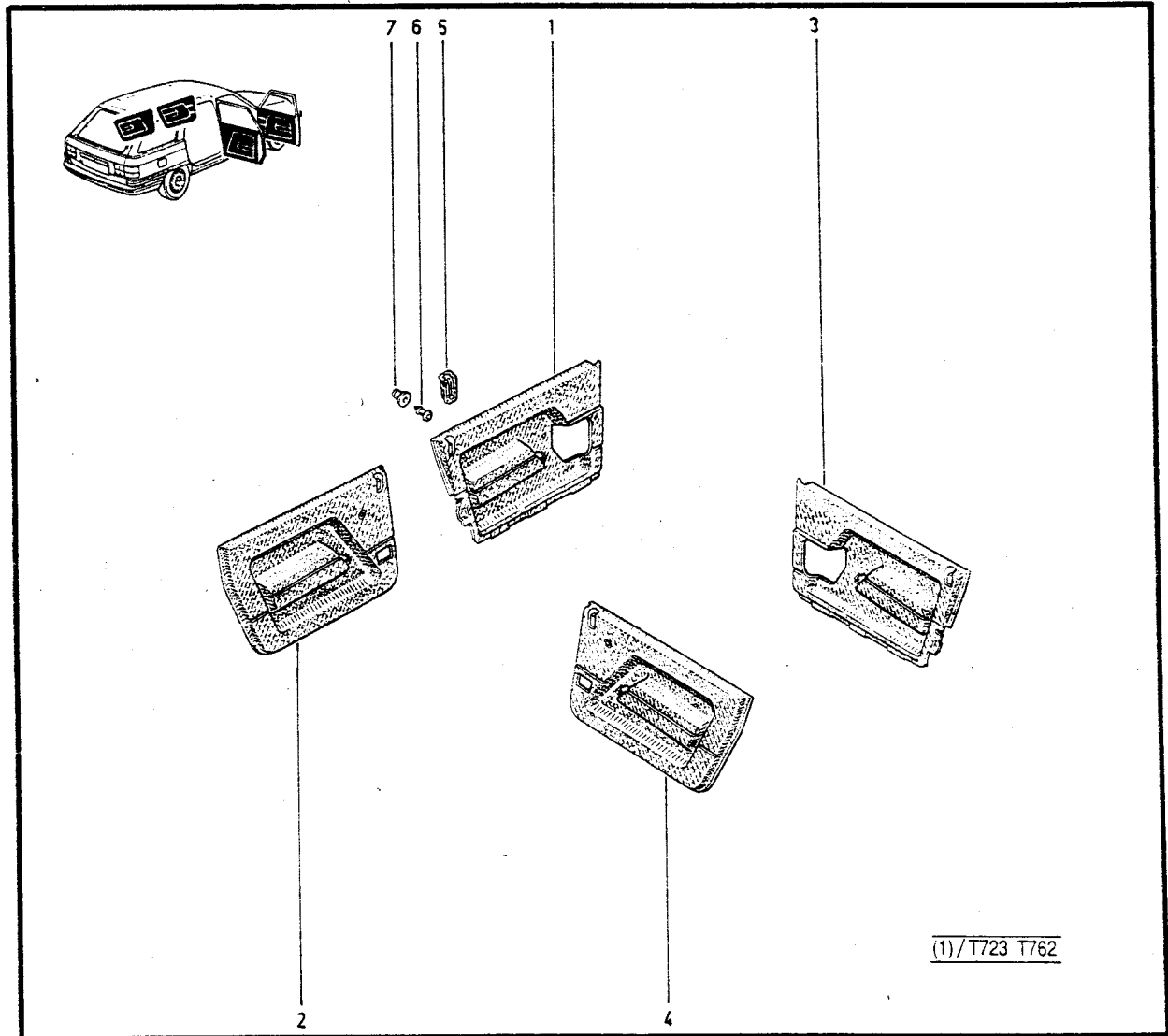
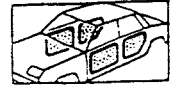

- (a) / K48X - K48Y
- (b) / L48X - L48S - L48Z - L48K - L48Y
- (c) / K48G - K487
- (d) / L48G

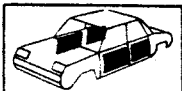

72.15

P.R. 1233

72.15

P.R. 1233

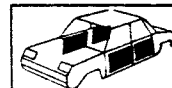

- 1- 77 00 790 474 [22] (b)
- 77 00 765 308 [22] (a)
- 2- 77 00 772 767 [22]
- 3- 77 00 763 428
- 4- 77 03 016 064
- 5- 77 00 764 283 [22] +
- 77 00 764 277 [22]
- 6- 77 00 773 906
- 7- 77 00 764 284 [22] +
- 77 00 764 278 [22]
- 8- 77 00 764 273
- 9- 77 00 765 051 [22] +
- 77 01 366 986 [22]
- 10- 77 00 765 309 [22] (a)
- 77 00 790 475 [22] (b)
- 11- 77 00 772 766 [22]
- 12- 77 00 772 903 [22]
- 13- 77 03 081 104
- 14- 77 00 764 011
- 15- 77 00 764 274
- 16- 77 00 765 052 [22] +
- 77 01 366 986 [22]
- 17- 77 03 077 045
- 18- 77 03 016 214
- 19- 77 03 081 026
- 20- 77 03 016 401
- 21- 77 03 046 098
- 22- 77 03 080 054
- 23- 77 00 766 684 [22] (c)
- 24- 77 00 764 283 [22] (c)
- 25- 77 00 764 284 [22] (c)
- 26- 77 00 772 765 [22] (c)
- 27- 77 00 772 766 [22] (c)

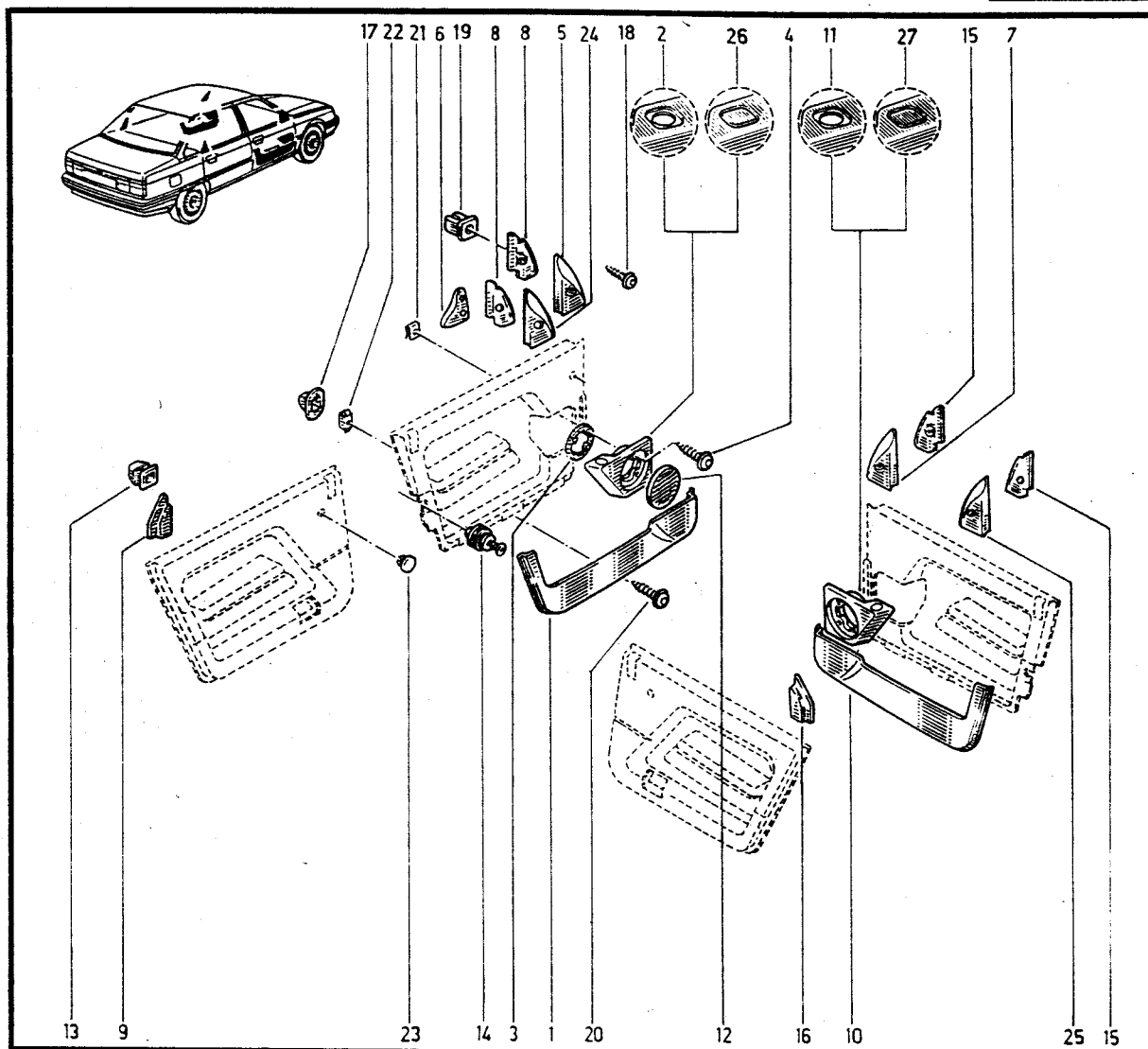

(a) / L48S ⇔ n° 1 ⇔ n° 06086

(b) / ⇔ MOD. 9110 ⇔ n°.....

(c) / L48G - L488 - L489

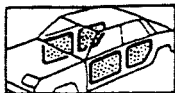

72.15.1

P.R. 1233

- 1- 77 00 790 474 [22]
- 77 00 765 308 [22] +
- 2- 77 00 772 767 [22]
- 3- 77 00 763 428
- 4- 77 00 772 903 [22]
- 5- 77 00 764 277 [22]
- 6- 77 00 773 906
- 7- 77 00 764 011
- 8- 77 00 764 273
- 9- 77 00 765 309 [22] +
- 77 00 790 475 [22]
- 10- 77 00 772 766 [22]
- 11- 77 00 764 278 [22]
- 12- 77 03 016 064
- 13- 77 03 077 045
- 14- 77 00 764 274
- 15- 77 00 766 684 [22]
- 16- 77 03 016 214
- 17- 77 03 081 026
- 18- 77 03 016 401
- 19- 77 03 046 038
- 20- 77 03 080 054
- 21- 77 00 766 684 [22]

72.15.1

P.R. 1233

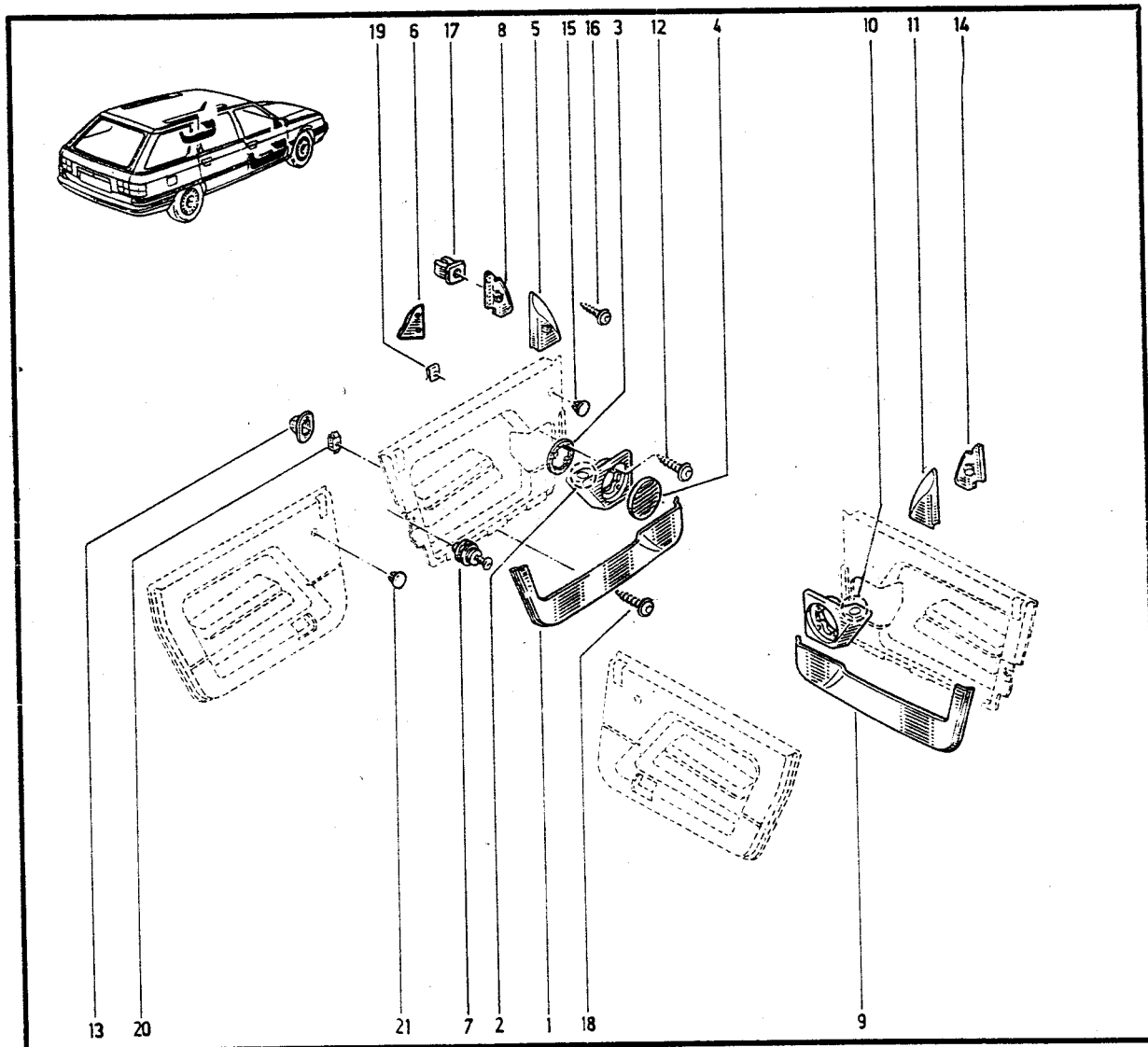
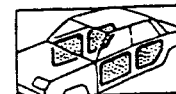



74.01

P.R. 1233

74.01

P.R. 1233

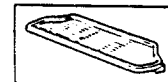

- 1- 77 02 211 242 ~~NN~~
- 77 02 204 322 ~~NN~~ (a)
- 77 02 209 010 ~~NN~~ (b)
- 2- 77 00 765 546 ~~NN~~
- 3- 77 03 016 401 ~~NN~~
- 4- 77 02 206 057 ~~NN~~
- 5- 77 03 076 164 ~~NN~~
- 6- 77 03 076 105 ~~NN~~
- 7- 77 03 008 051 ~~NN~~
- 8- 77 03 077 068 ~~NN~~
- 9- 77 03 046 098 ~~NN~~
- 10- 77 00 780 339 ~~NN~~
- 11- 77 00 780 338 ~~NN~~
- 12- 77 00 780 387 ~~NN~~
- 13- 77 00 763 428 ~~NN~~
- 14- 77 00 711 709 ~~NN~~
- 15- 77 00 782 775 ~~NN~~
- 16- 77 01 203 110 ~~NN~~
- 17- 77 01 203 105 ~~NN~~

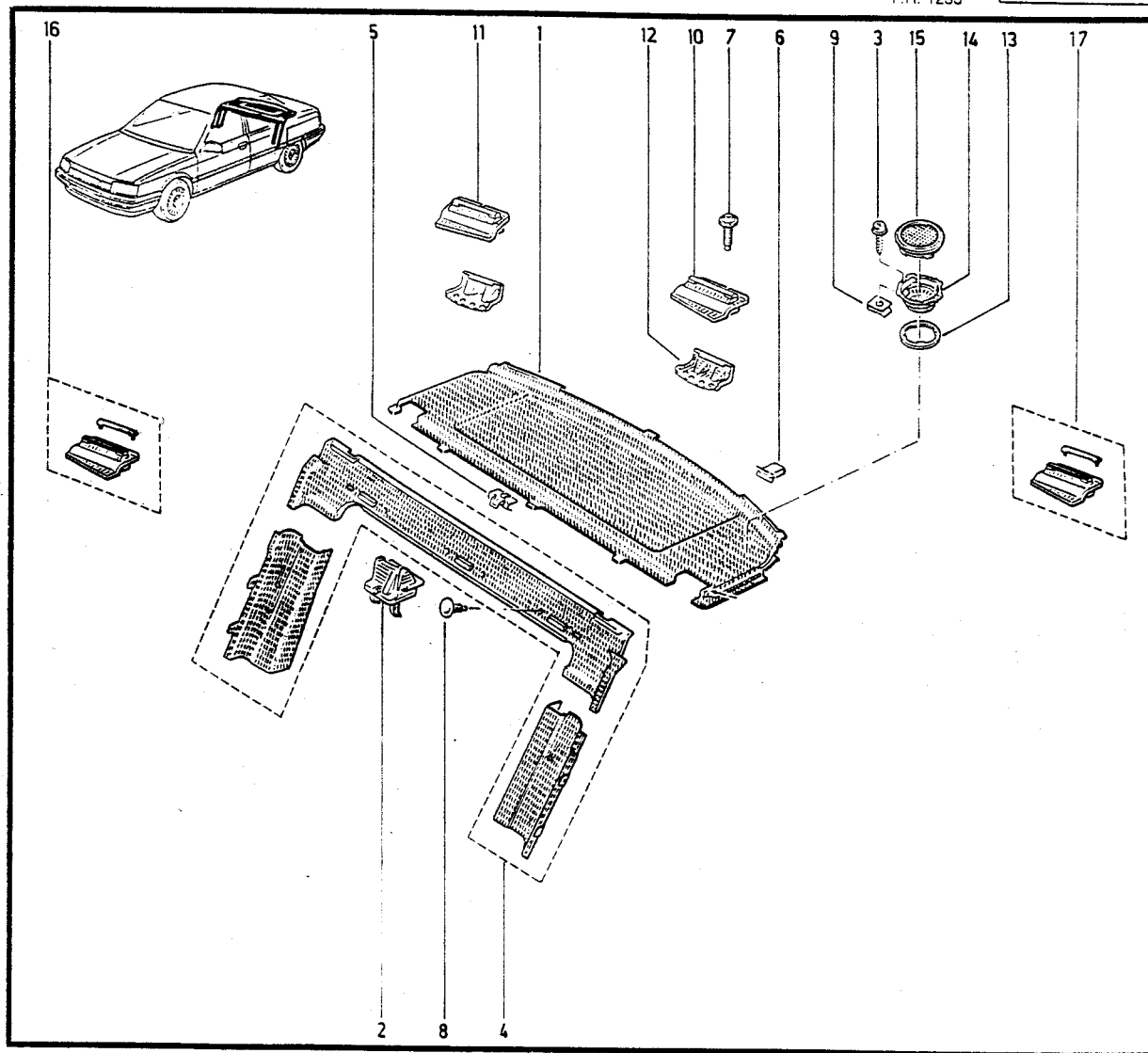

(a)/L489 - L488 - L48G

(b)/L48S - L48X - L48Y

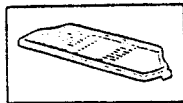

74.05
P.R. 1233

- 1- 77 02 210 843 [22]
- 2- 77 00 771 690
- 77 02 211 000
- 3- 77 00 780 314 [22]
- 4- 77 01 202 863 [22]
- 5- 77 01 202 797

74.05
P.R. 1233

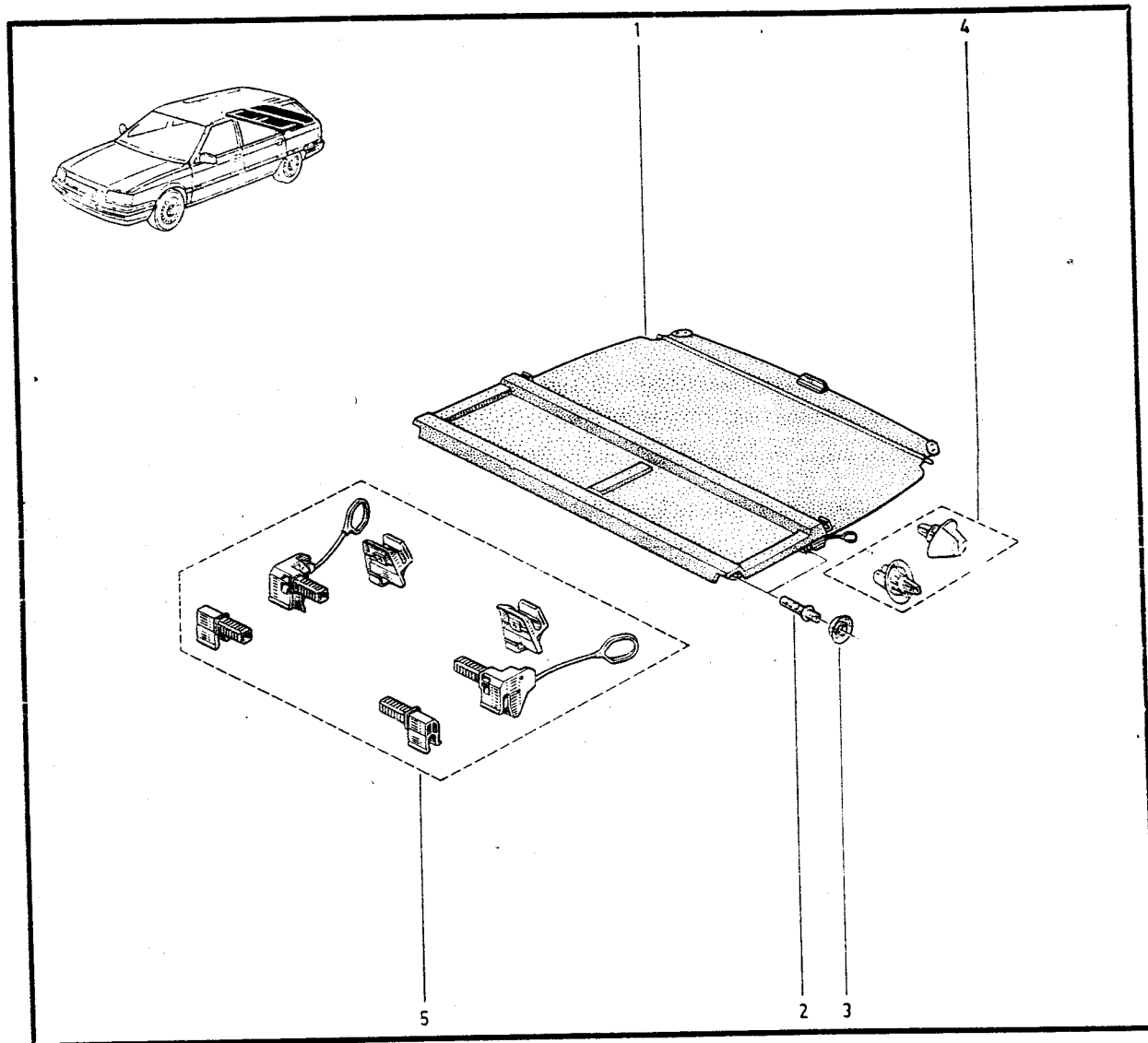
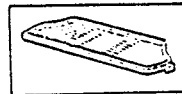



75.01
P.R. 1233

- 1 - 77 02 204 318
- 2 - 77 00 769 445
- 3 - 77 02 204 319
- 4 - 77 00 769 446

75.01
P.R. 1233

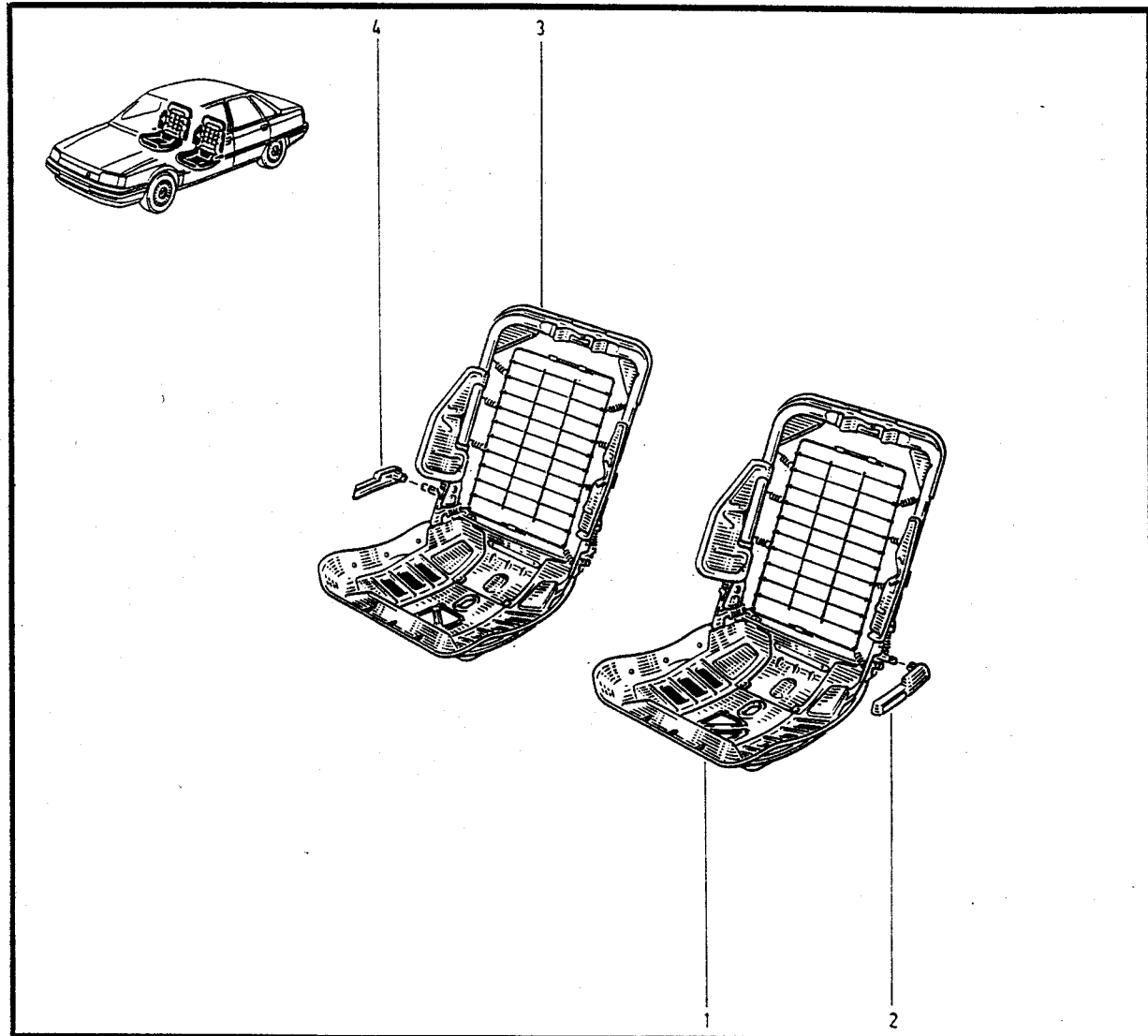

75.10

P.R. 1233

75.10

P.R. 1233

- 1 - 77 00 783 246 (a)
- 77 00 792 603 (b)
- 2 - 77 00 769 455
- 3 - 77 00 769 456
- 4 - 77 00 783 245 (a)
- 77 00 792 603 (b)
- 5 - 77 00 769 454
- 6 - 77 00 772 601
- 7 - 77 03 001 158
- 8 - 77 03 058 008
- 9 - 77 03 006 123
- 10 - 77 03 058 048
- 11 - 77 00 760 905
- 12 - 77 03 044 052
- 13 - 77 03 033 039
- 14 - 77 03 025 004

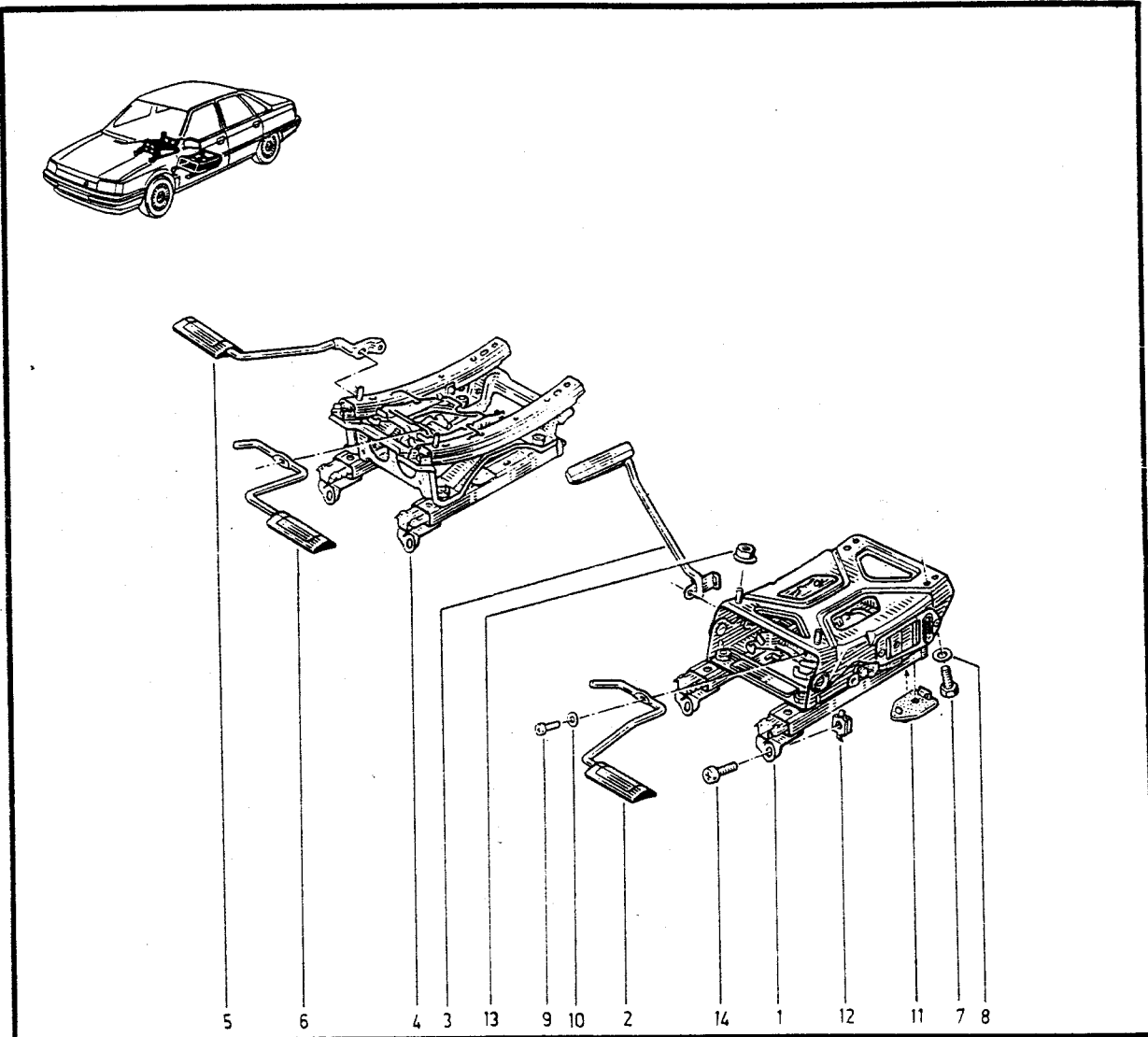

- (a) L48S - K48S - L48Z - K48X - L48Y
- (b) L489 - K489 - L488 - K488 - K48G



75.10.1
P.R. 1233

- 1 - 77 00 792 603
- 2 - 77 00 769 453
- 3 - 77 00 792 603
- 4 - 77 00 769 454

75.10.1
P.R. 1233

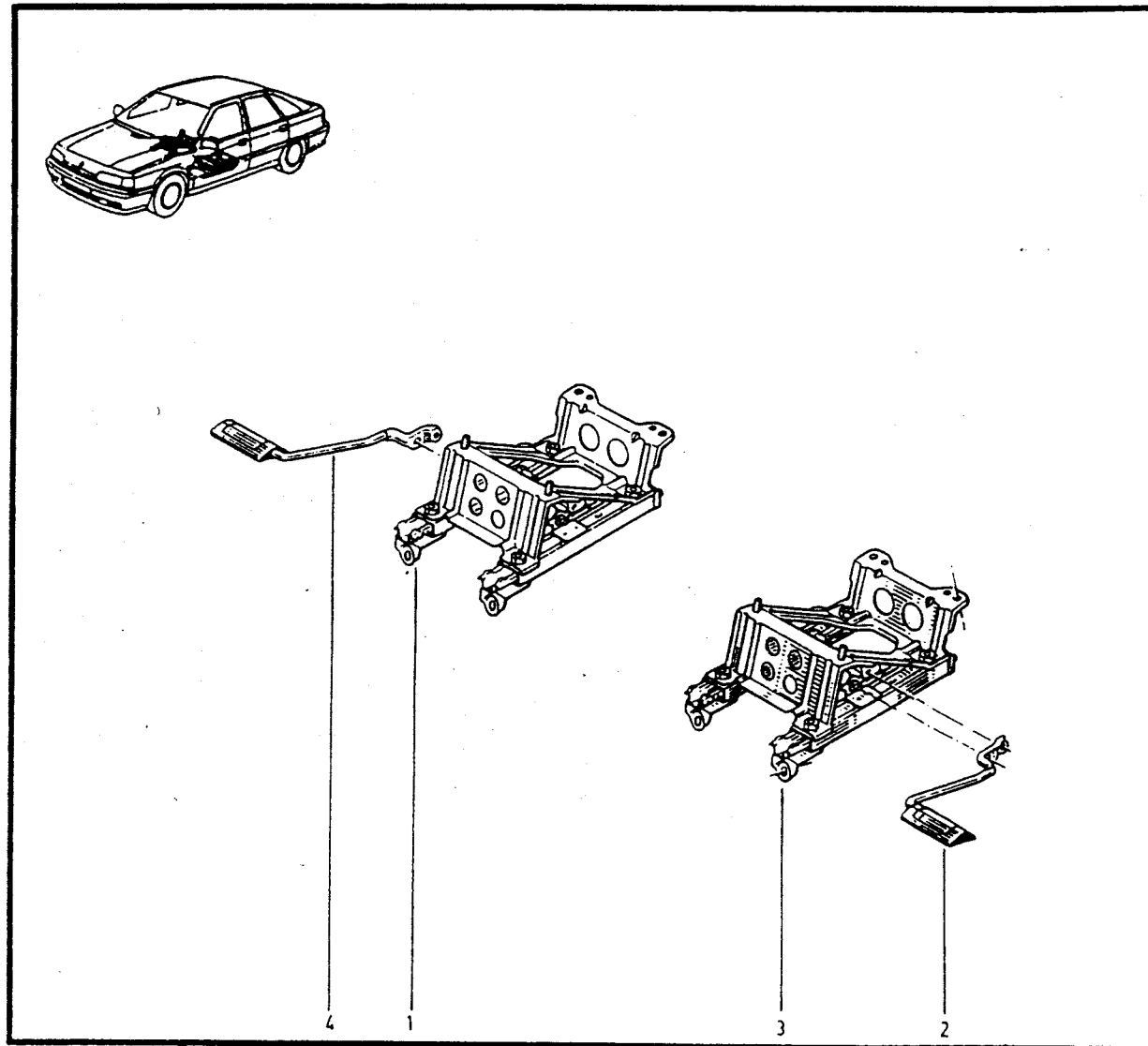

L48G - K487



76.01

P.R. 1233

6

76.01

P.R. 1233



- 1 - 77 00 769 914
- 2 - 77 00 769 902
- 3 - 79 03 032 018
- 4 - 79 03 053 043
- 5 - 77 00 769 904
- 6 - 77 00 769 905
- 7 - 77 03 016 407
- 8 - 77 00 770 070
- 9 - 77 03 053 043
- 10 - 79 03 032 018
- 11 - 77 03 058 002
- 12 - 77 03 001 118
- 13 - 77 00 773 987
- 14 - 77 00 775 641 [2]
- 15 - 77 00 776 356 [5]
- 16 - 77 00 674 564
- 17 - 77 00 769 903
- 18 - 77 00 769 907
- 19 - 02 20 166 300 †

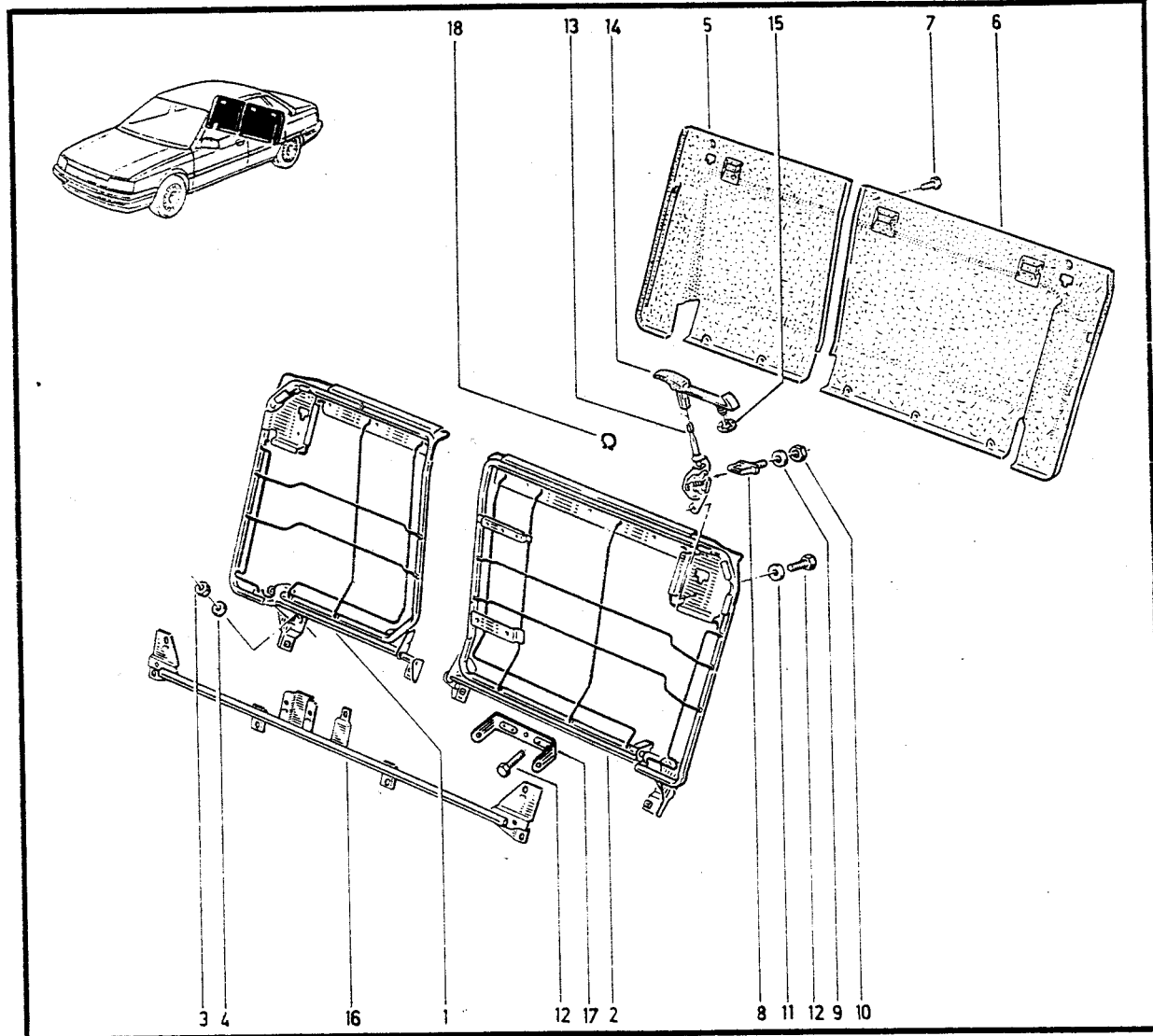



76.03

P.R. 1233

6

76.03

P.R. 1233



- 1- 77 00 774 040
- 2- 77 00 785 222
- 3- 77 03 001 118
- 4- 77 00 774 335 [22]
- 5- 77 00 785 220
- 6- 77 03 077 112
- 7- 77 00 774 020 [22]
- 8- 77 00 774 019
- 9- 77 00 774 021 [22]
- 10- 77 03 019 120
- 11- 77 00 774 389
- 12- 77 00 785 221
- 13- 77 00 778 851 [22]
- 14- 77 03 016 407
- 15- 77 00 774 683
- 16- 77 00 755 156
- 17- 77 00 777 048 [22]
- 18- 77 00 774 015
- 19- 77 00 774 016
- 20- 77 03 033 039
- 21- 77 00 773 920 †
- 77 00 797 013
- 22- 77 00 776 531 [22]
- 23- 77 03 001 162
- 24- 77 00 776 525 [22]
- 25- 77 00 774 336
- 26- 77 00 773 919 †
- 77 00 797 012
- 27- 77 00 776 532 [22]
- 28- 77 00 776 526 [22]
- 29- 77 02 147 800 [22]
- 30- 77 02 147 803 [22]

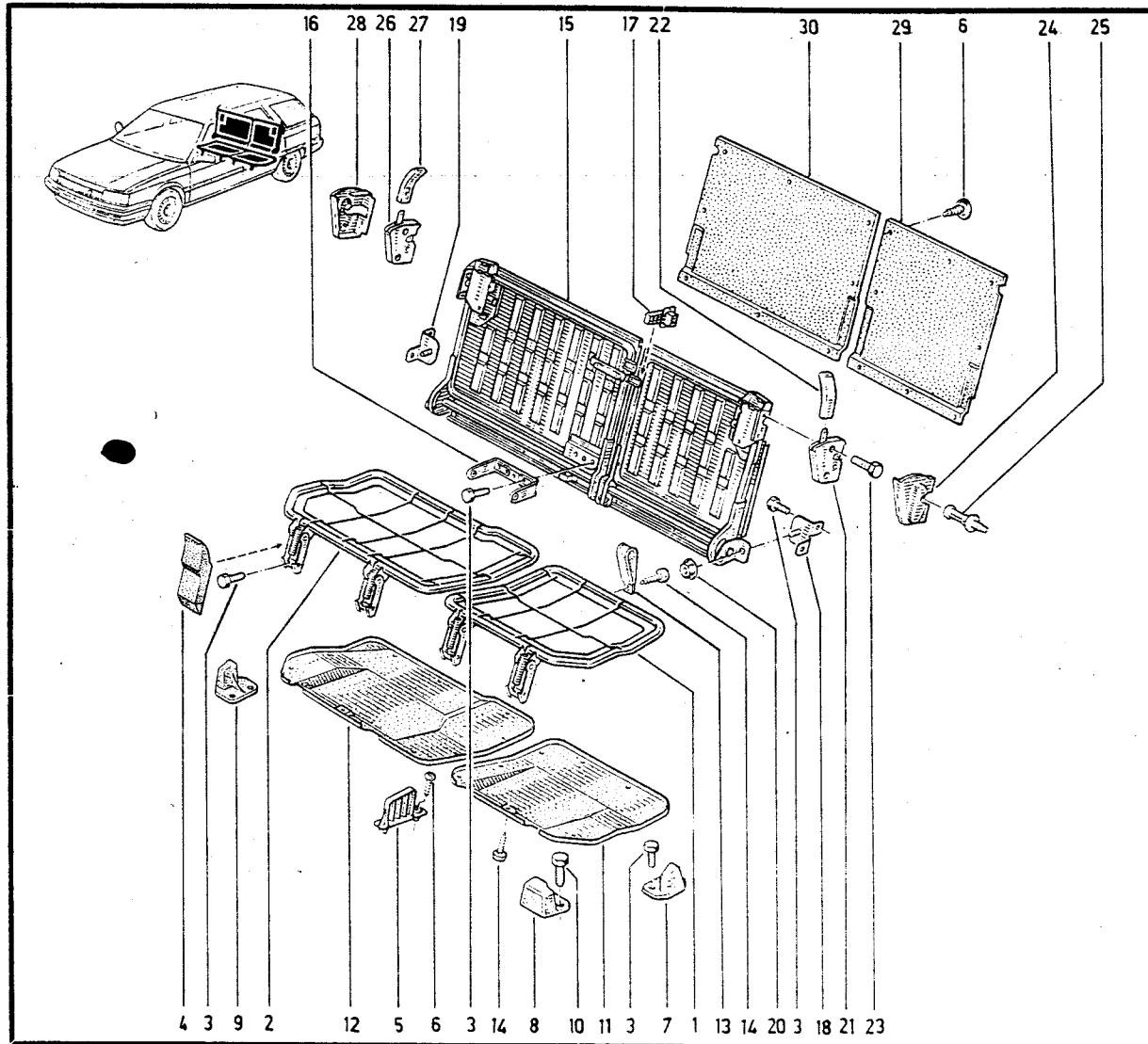



76.04

P.R. 1233



76.04

P.R. 1233



- 1- 77 00 774 025
- 2- 77 03 001 118
- 3- 77 00 774 335 22
- 4- 77 00 778 851 22
- 5- 77 03 016 407
- 6- 77 00 774 019
- 7- 77 03 019 120 †
- 77 03 101 160
- 8- 77 00 774 020 22
- 9- 77 00 774 021 22
- 10- 77 00 774 386
- 11- 77 00 773 909
- 12- 77 00 760 170
- 13- 77 00 774 015
- 14- 77 03 033 039
- 15- 77 00 774 016
- 16- 77 00 797 013
- 17- 77 00 776 531 22
- 18- 77 03 001 162
- 19- 77 00 796 495 22
- 20- 77 00 774 336
- 21- 77 00 773 919
- 22- 77 00 776 532 22
- 23- 77 00 796 496 22
- 24- 77 00 776 422
- 25- 77 03 077 112

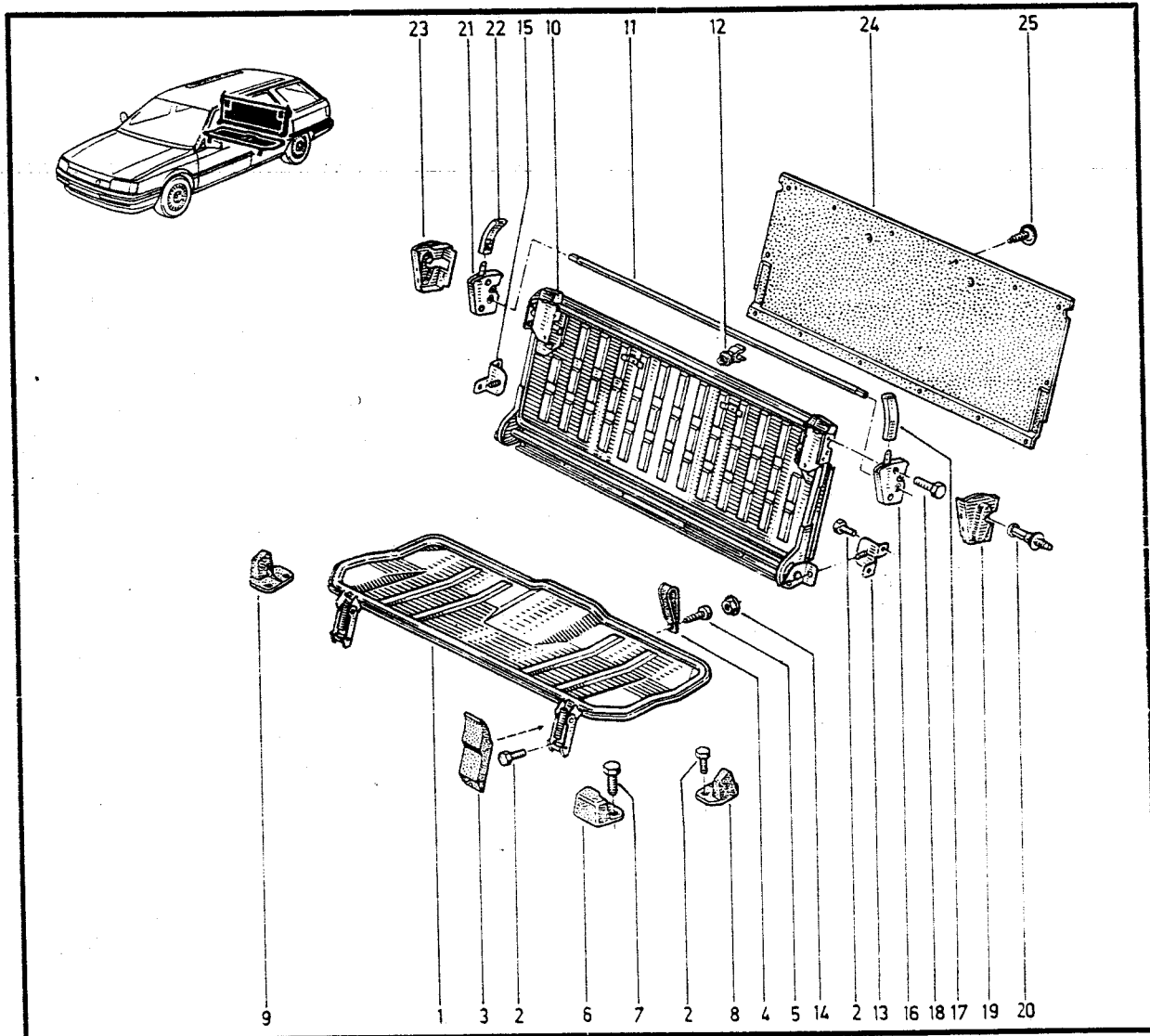



76.06

P.R. 1233

L

76.06

P.R. 1233



- 1-77 00 774 424
- 2-77 01 032 886
- 3-77 01 202 869:22
- 4-77 03 016 416
- 5-77 00 774 420
- 6-77 03 101 069
- 7-77 00 778 173:22
- 8-77 03 016 401
- 9-77 01 202 636:22
- 10-77 03 077 197
- 11-77 00 774 425
- 12-77 00 796 004
- 13-77 03 001 118
- 14-77 01 202 642:22
- 15-77 00 775 078
- 16-77 00 774 423
- 17-77 01 032 887
- 18-77 01 202 639:22
- 19-77 00 774 422
- 20-77 00 776 378
- 21-77 00 774 400
- 22-77 00 774 419
- 23-77 03 032 103
- 24-77 01 202 934:22
- 25-77 01 202 645
- 26-77 03 001 820
- 27-77 03 072 236
- 28-77 03 072 172
- 29-77 01 033 191
- 30-77 03 077 112

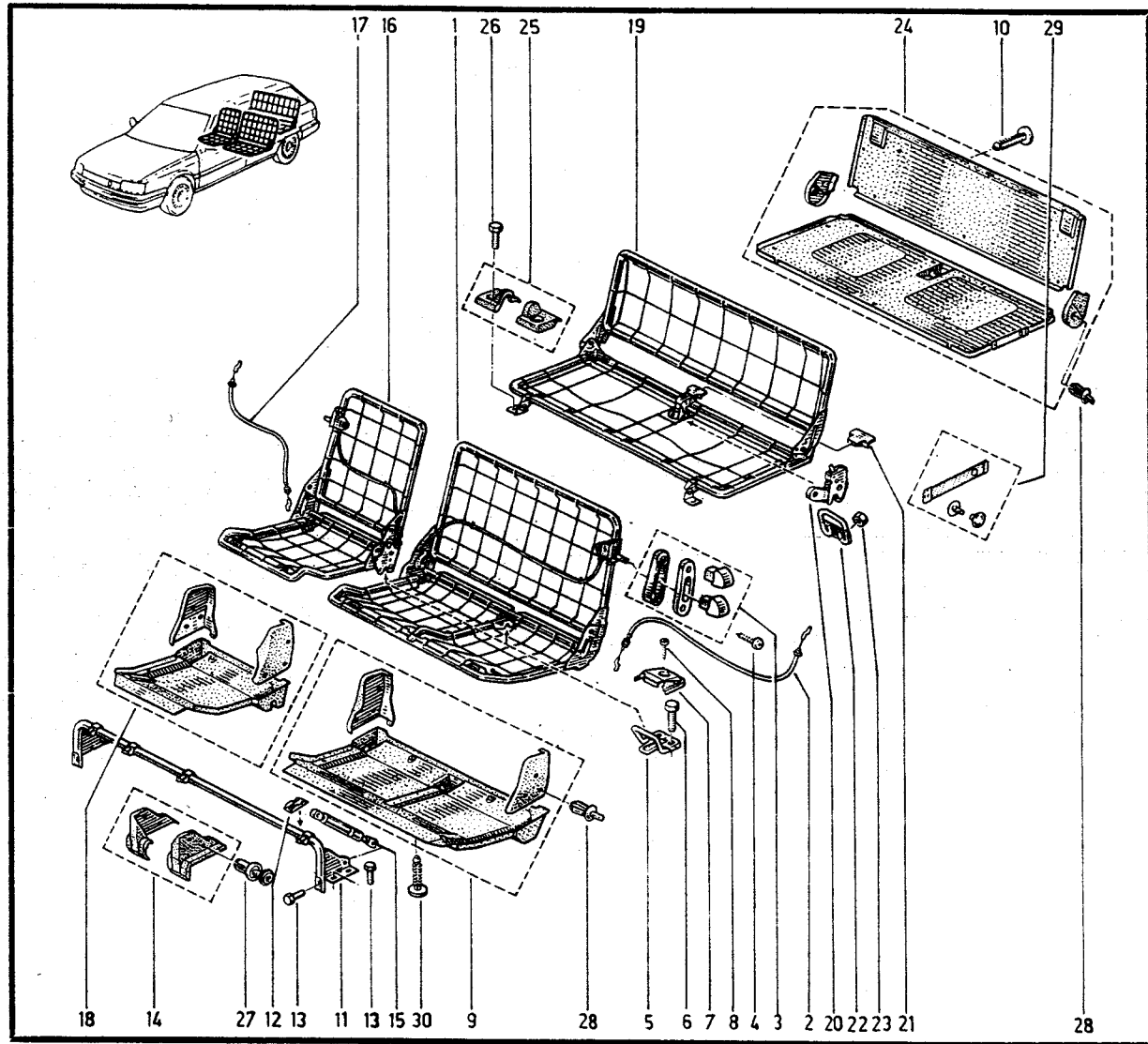



77.01

P.R. 1233

1 - 77 02 204 788
2 - 77 00 778 866

77.01

P.R. 1233

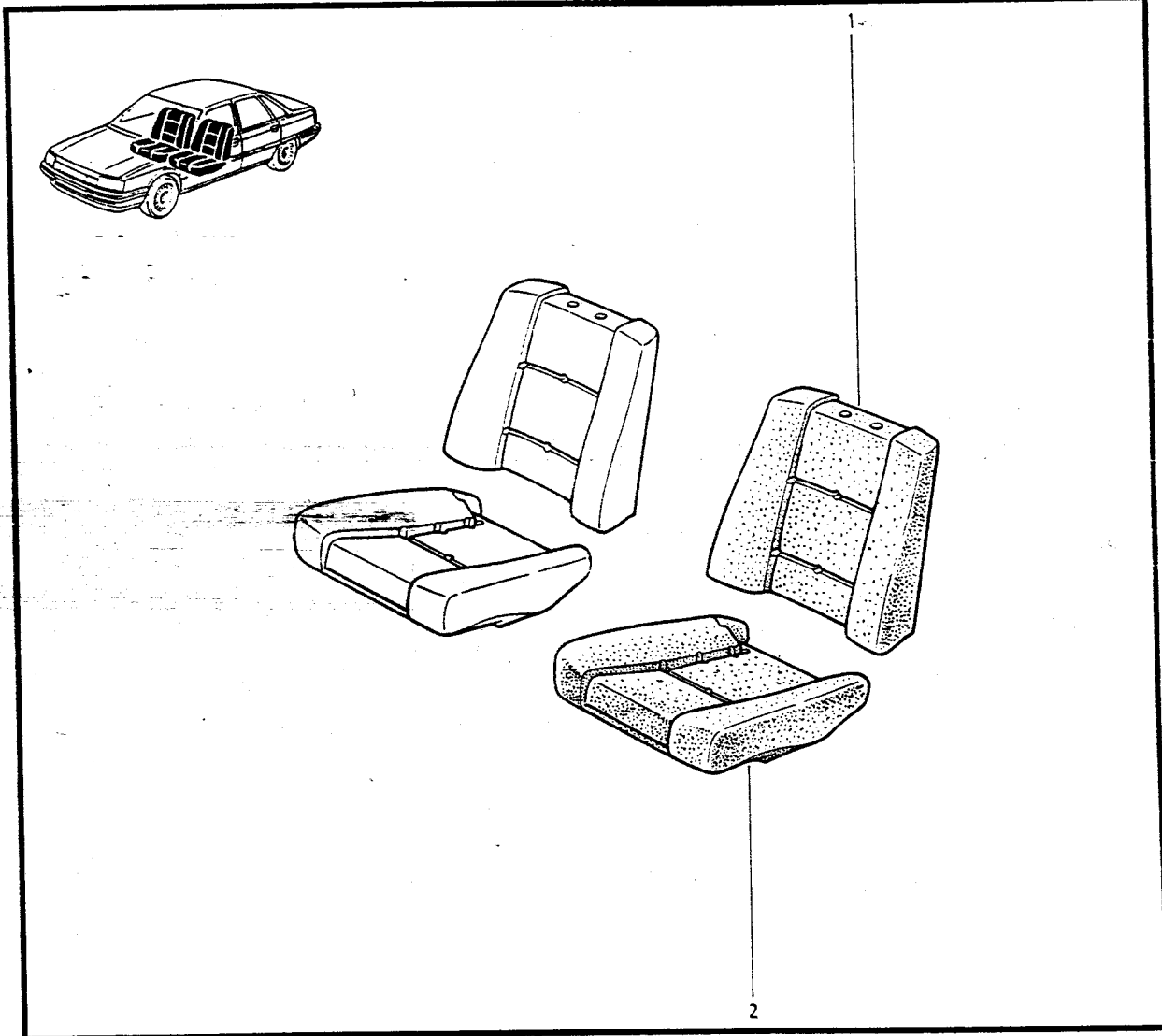



77 . 12

P.R. 1233

- 1- 77 02 212 309 [22] (1)
- 77 02 215 804 [5] [1] (2)
- 2- 77 02 212 305 [22] (1)
- 77 02 215 802 [5] [1] (2)
- 3- 77 02 074 026

77 . 12

P.R. 1233

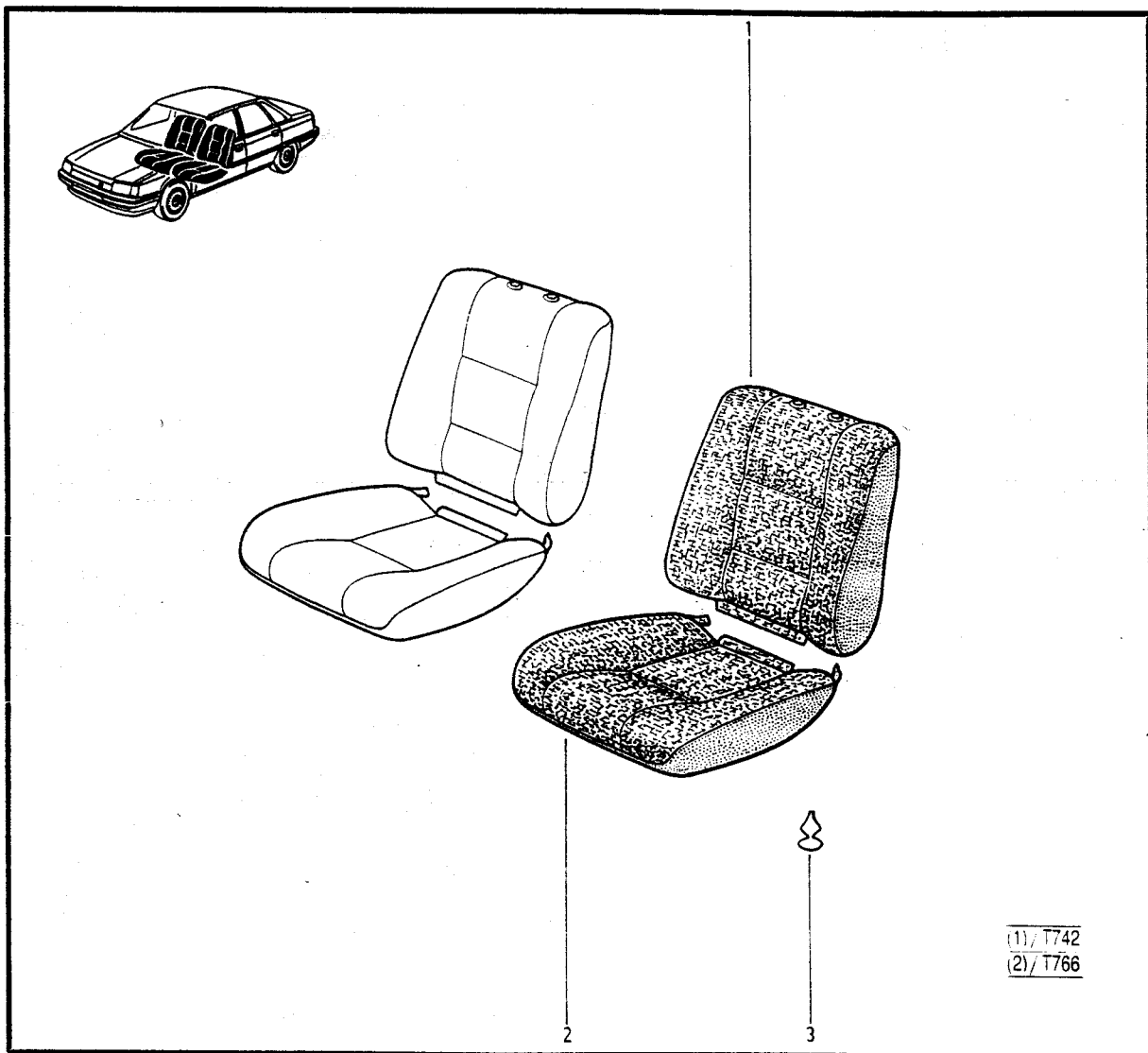

(1) / T742
 (2) / T766

L48S	[1]	n° 04241	⇔	n°
K48S	[1]	n° 1	⇔	n°
L48X	[1]	n° 1	⇔	n°
K48X	[1]	n° 1	⇔	n°
L48X	[1]	n° 1	⇔	n°



77.20

P.R. 1233

- 1- 77 02 212 313 (22) (1)
- 2- 77 02 212 305 (22) (1)
- 3- 77 02 074 026

77.20

P.R. 1233

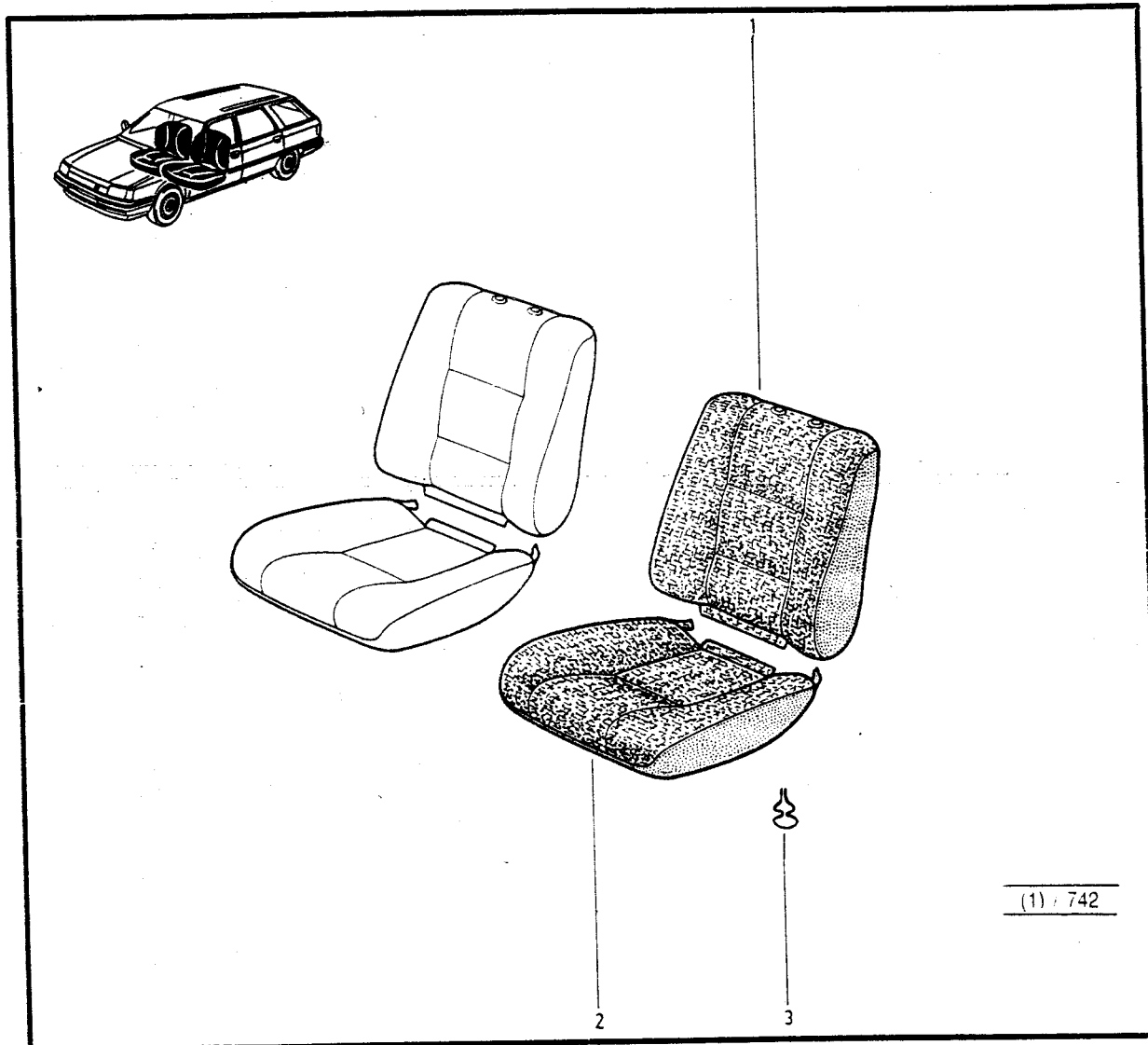

(1) / 742

K48G	II	n ²	1	⇨	n ²
L48G	II	n ²	1	⇨	n ²
K488	II	n ²	1	⇨	n ²
L488	II	n ²	1	⇨	n ²
K489	II	n ²	1	⇨	n ²
L489	II	n ²	1	⇨	n ²

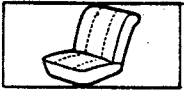

77.20.1

P.R. 1233

77.20.1

P.R. 1233



- 1- 77 02 220 301 [22] (1)(b)
- 77 02 220 244 [22] (1)(a)
- 77 02 215 803 [5] (2)
- 2- 77 02 220 243 [22] (1)(a)(b)
- 77 02 215 801 [5] (2)
- 3- 77 02 074 026

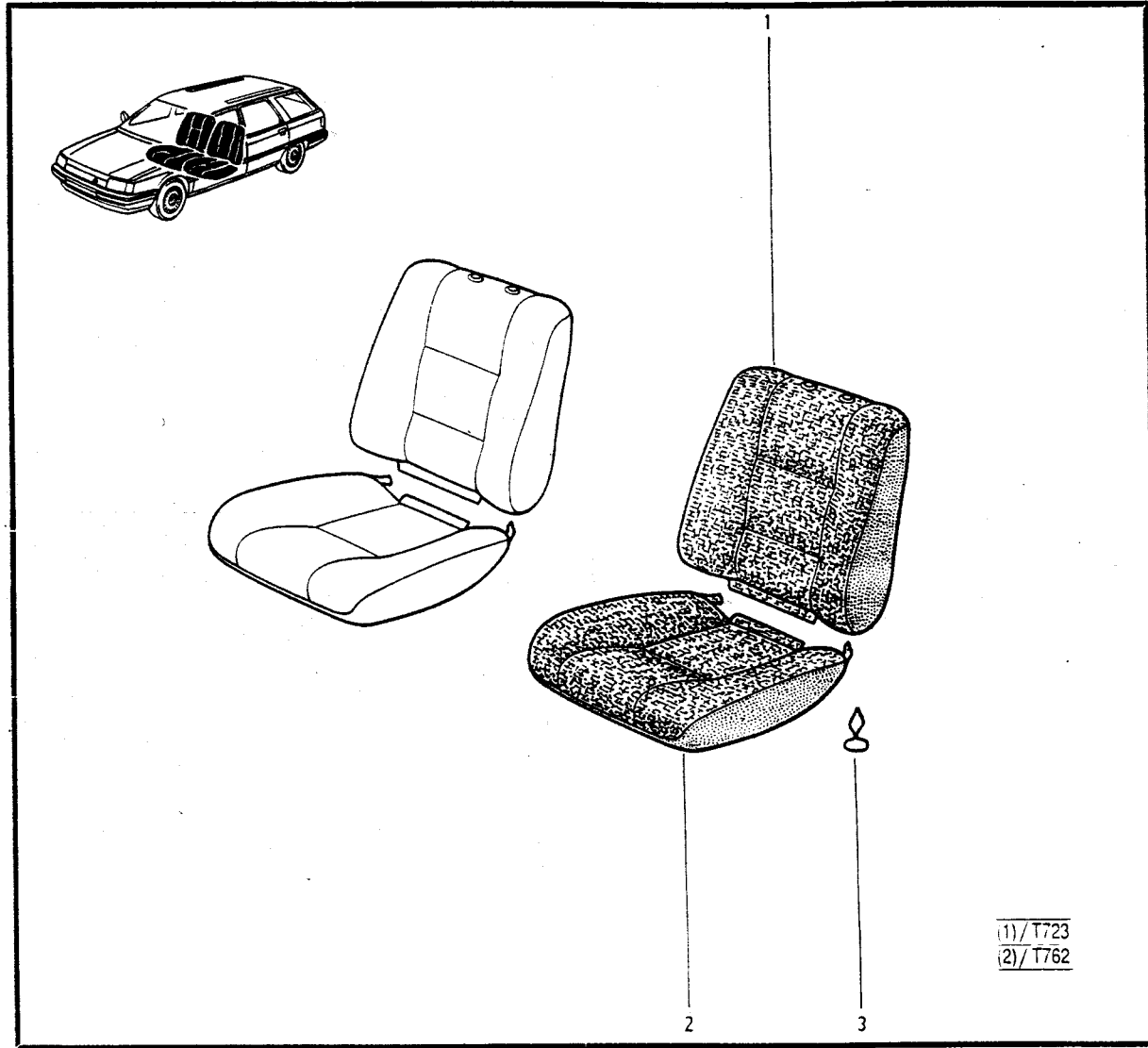

(1)/ T723
 (2)/ T762

(a) / K487
 K48G
 L48G

(b) / L48S
 L48X
 L48K
 K48Y
 K48X



78.01

P.R. 1233

8

78.01

P.R. 1233



- 1 - 77 00 769 912
- 2 - 77 00 769 913
- 3 - 77 00 769 212
- 4 - 77 00 649 940

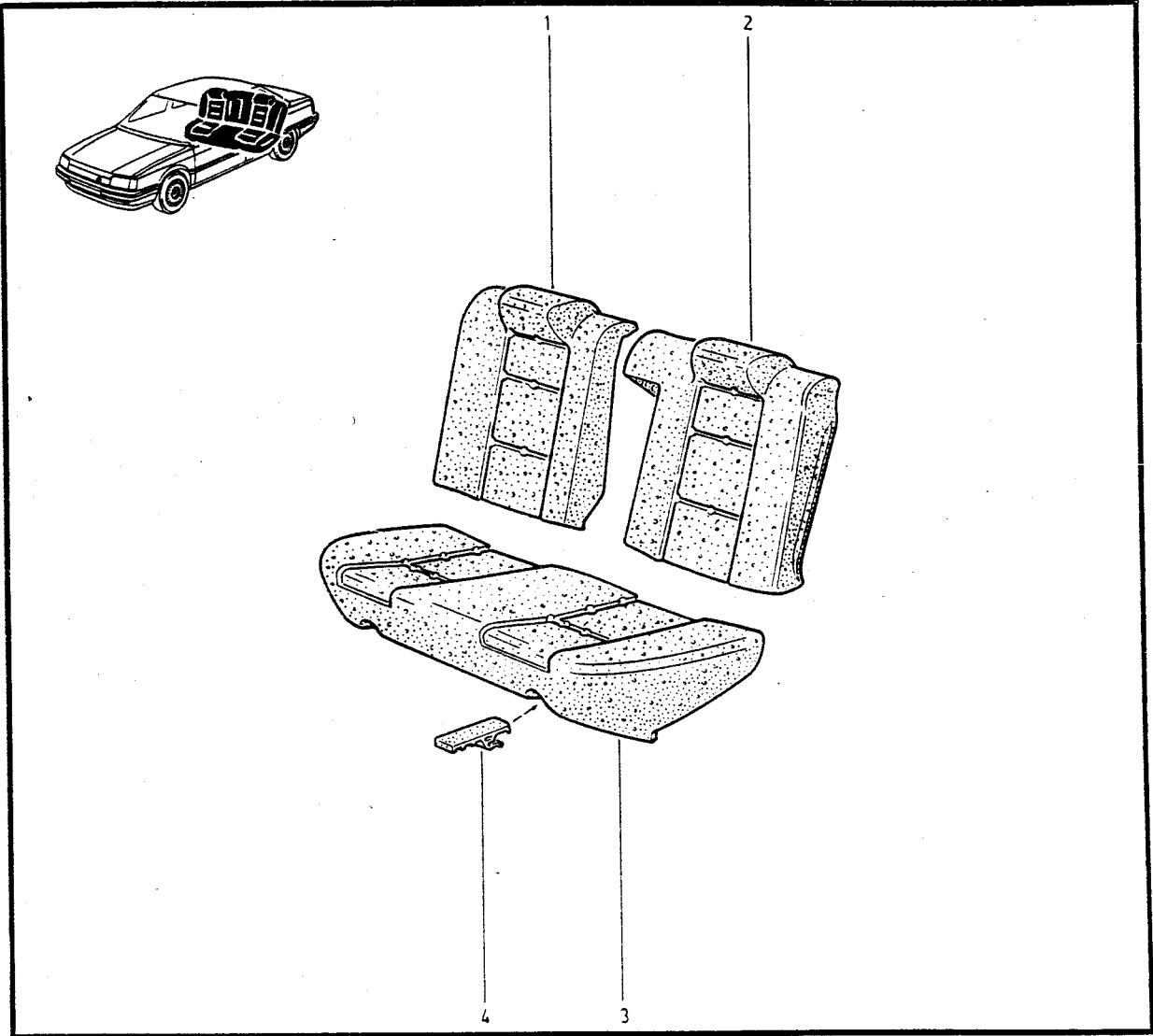
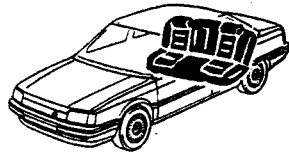



78 .02

P.R. 1233

H

78 .02

P.R. 1233



- 1- 77 00 782 515
- 2- 77 00 769 212
- 3- 77 00 649 940

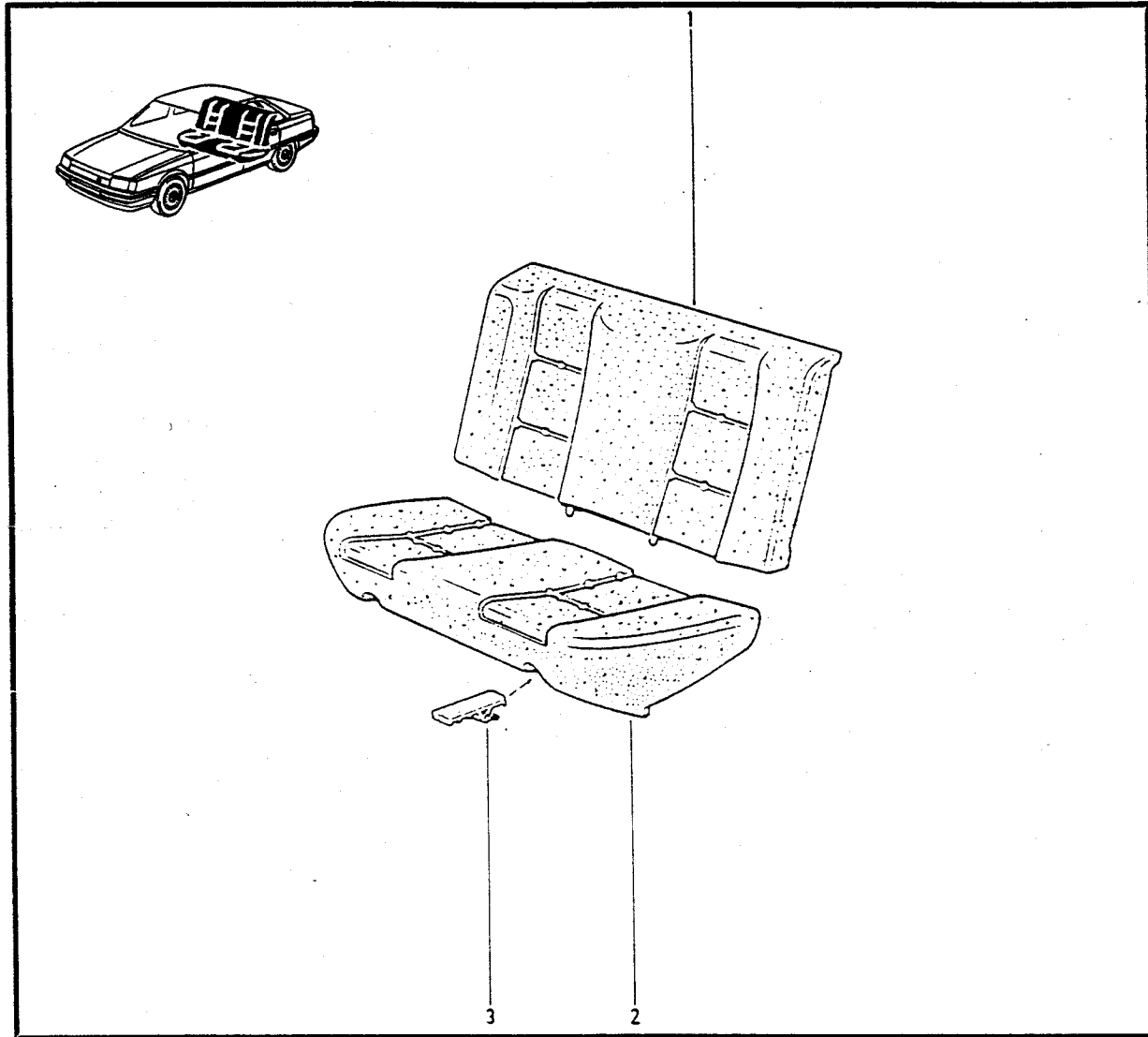

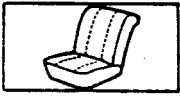

78.03
P.R. 1233



78.03
P.R. 1233



- 1 - 77 00 774 334
- 2 - 77 00 785 223
- 3 - 77 00 774 333
- 4 - 77 00 773 564
- 5 - 77 00 777 624
- 6 - 77 00 777 625
- 7 - 77 00 777 886

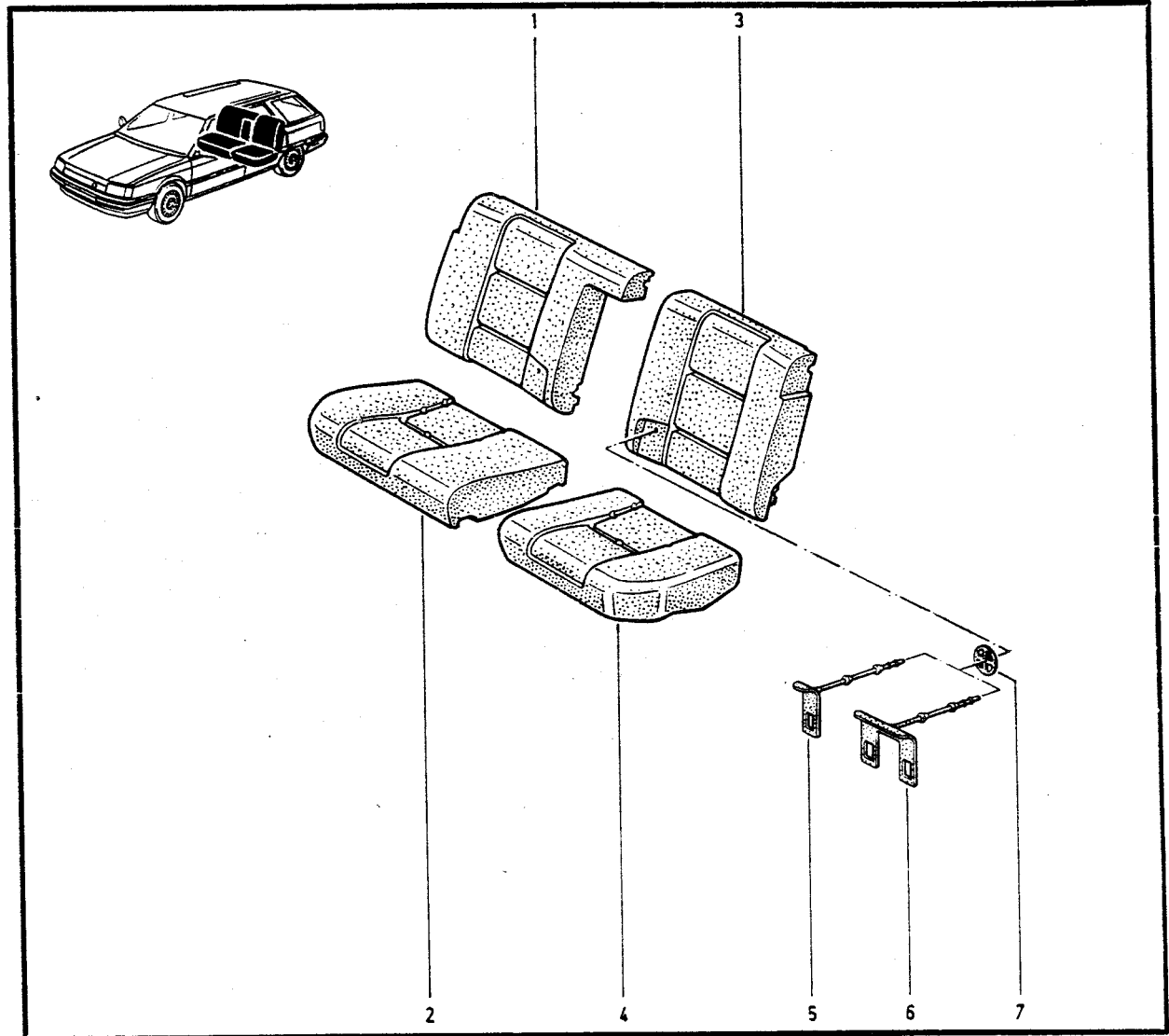



78.04

P.R. 1233



78.04

P.R. 1233



- 1- 77 00 774 332
- 2- 77 00 797 628
- 3- 77 00 777 624
- 4- 77 00 777 625
- 5- 77 00 777 886

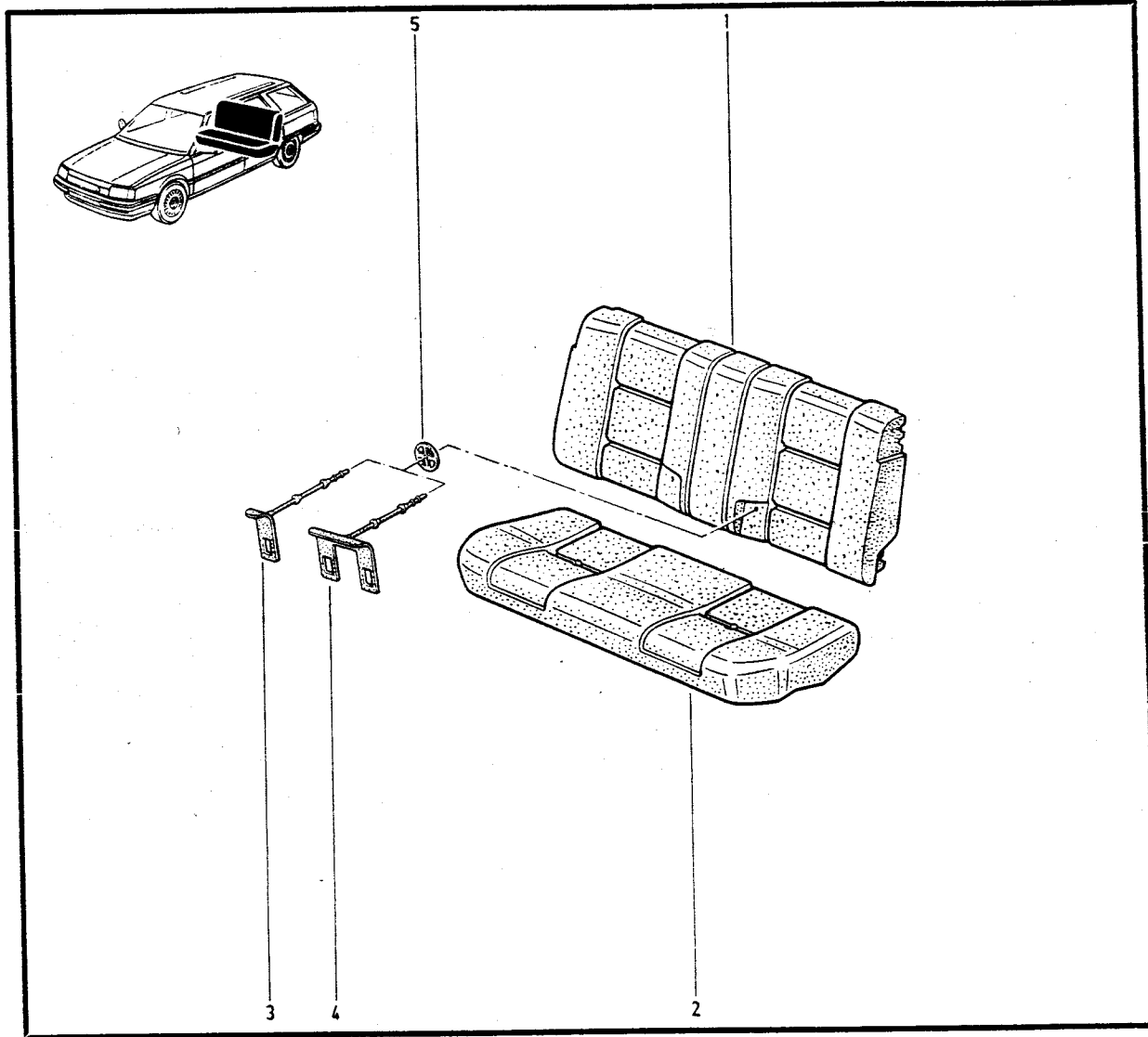



78 .05

P.R. 1233



78 .05

P.R. 1233



- 1- 77 00 774 418 +
- 77 00 777 070
- 2- 77 00 774 415 +
- 77 00 777 067
- 3- 77 00 774 417 +
- 77 00 777 065
- 4- 77 00 774 413 +
- 77 00 777 069
- 5- 77 00 774 416 +
- 77 00 777 066
- 6- 77 00 774 414 +
- 77 00 777 068

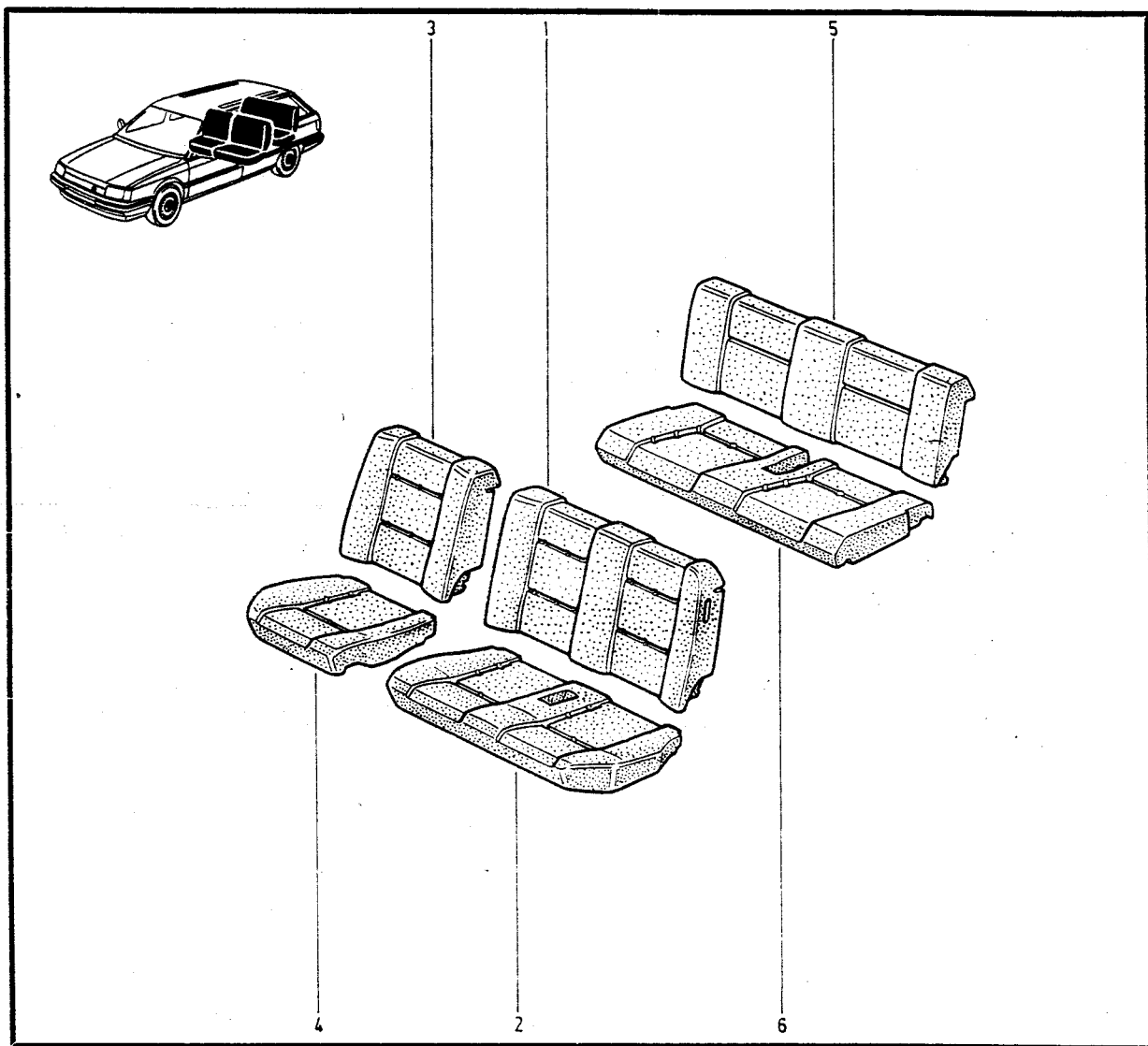



78.10

P.R. 1233

- 1- 77 02 213 351 [22] (1)
- 77 02 215 810 [5] (2)
- 2- 77 02 213 355 [22] (1)
- 77 02 215 808 [5] (2)
- 3- 77 02 212 317 [22] (1)
- 77 02 215 806 [5] (2)

78.10

P.R. 1233

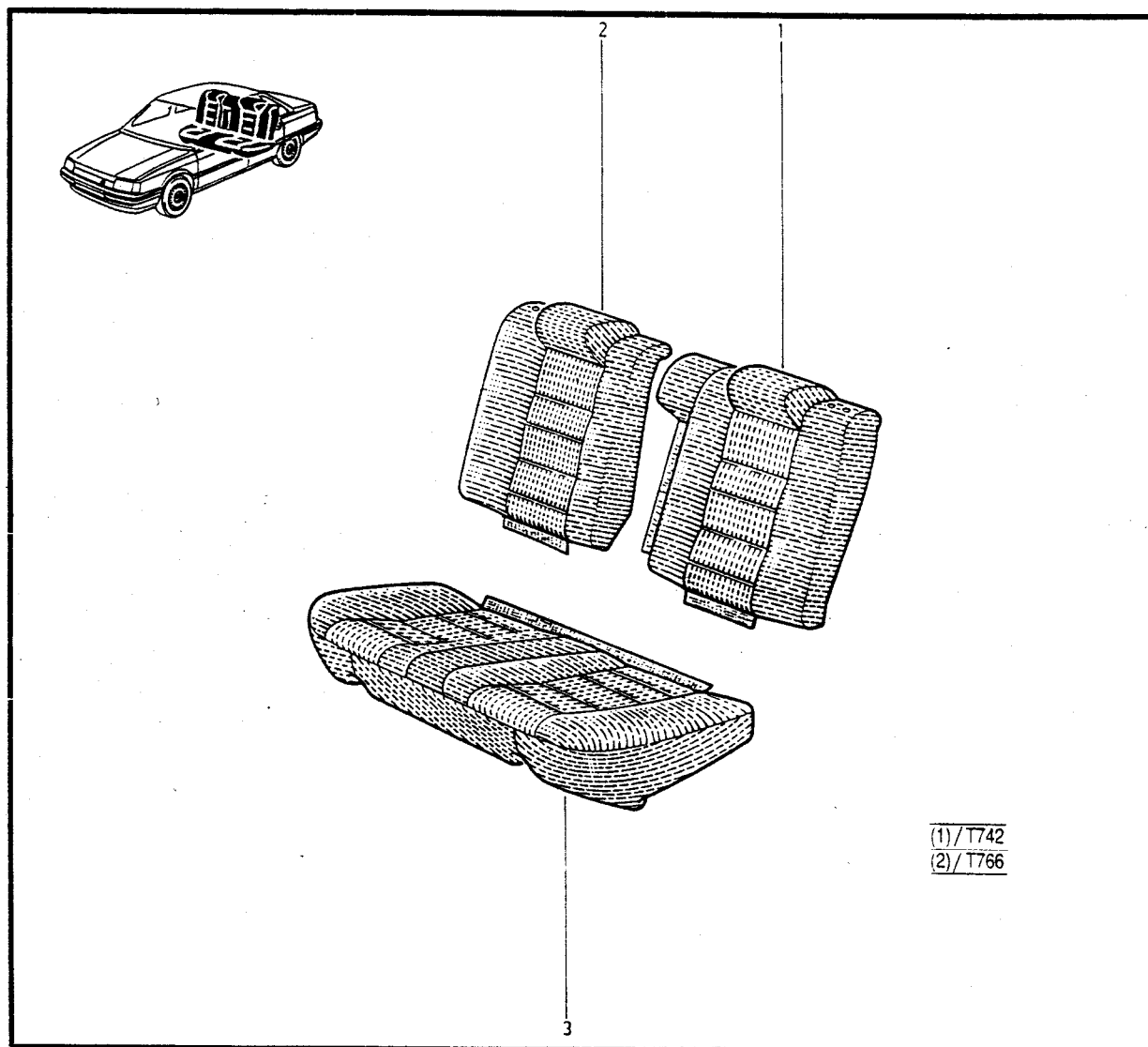

L48K
L48X
L48S

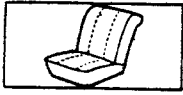

78.10.1

P.R. 1233

78.10.1

P.R. 1233

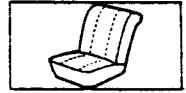

- 1- 77 02 220 322 [22] (1)
- 77 02 215 380 [22] (2)
- 2- 77 02 220 321 [22] (1)
- 77 02 215 374 [22] (2)
- 3- 77 02 220 319 [22] (1)
- 77 02 215 378 [22] (2)
- 4- 77 02 220 318 [22] (1)
- 77 02 215 370 [22] (2)

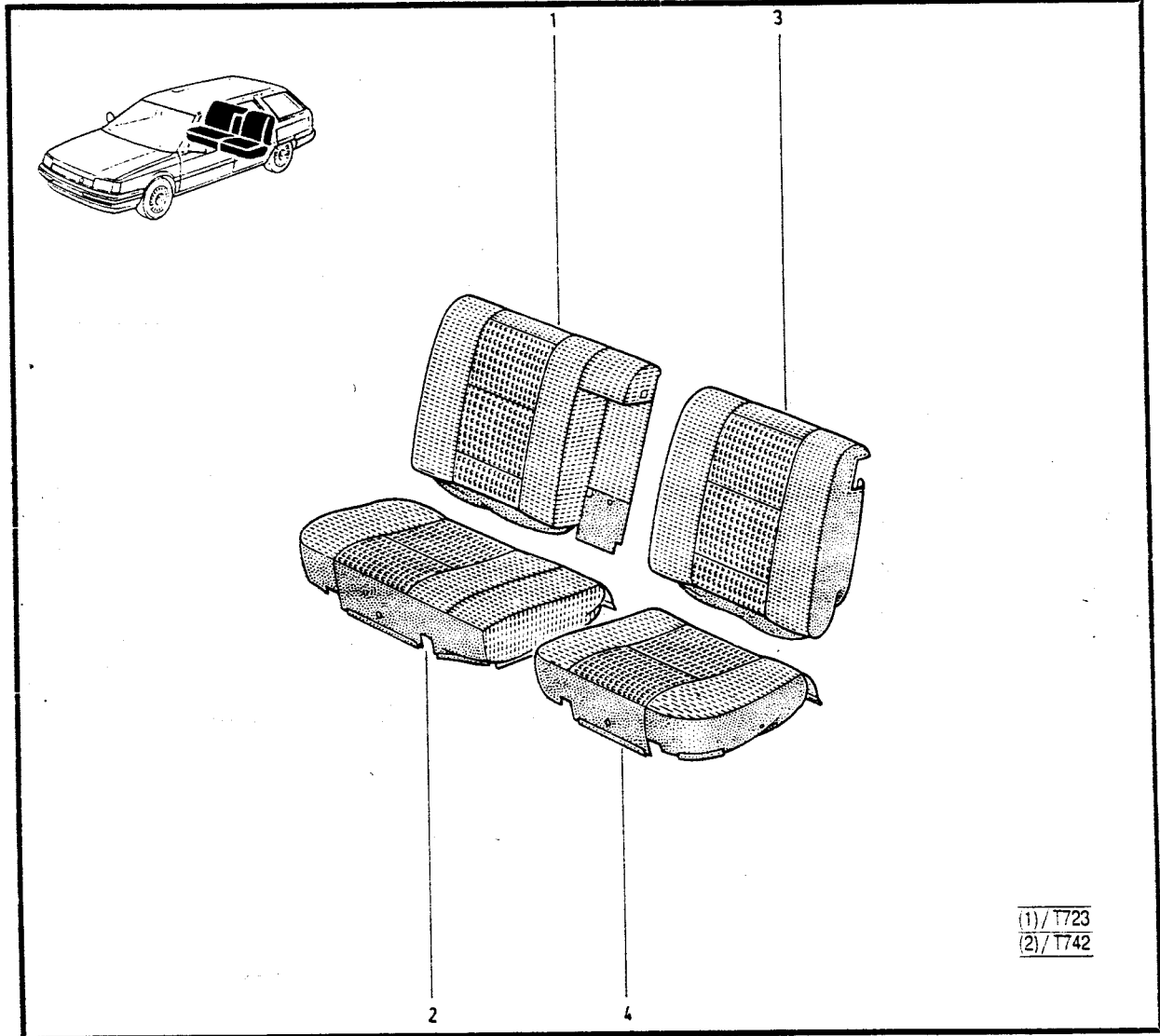
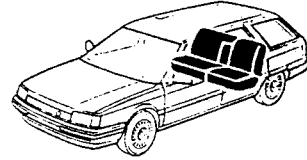

(1) / T723
 (2) / T742

K48S		n²	1		n².....
K48Y 090		n²	1		n².....



78.10.2

P.R. 1233

78.10.2

P.R. 1233



- 1 - 77 02 213 456 [22] (1) (a)
- 77 02 212 321 [22] (1) (b)
- 2 - 77 02 213 453 [22] (1) (a)
- 77 02 212 317 [22] (1) (b)

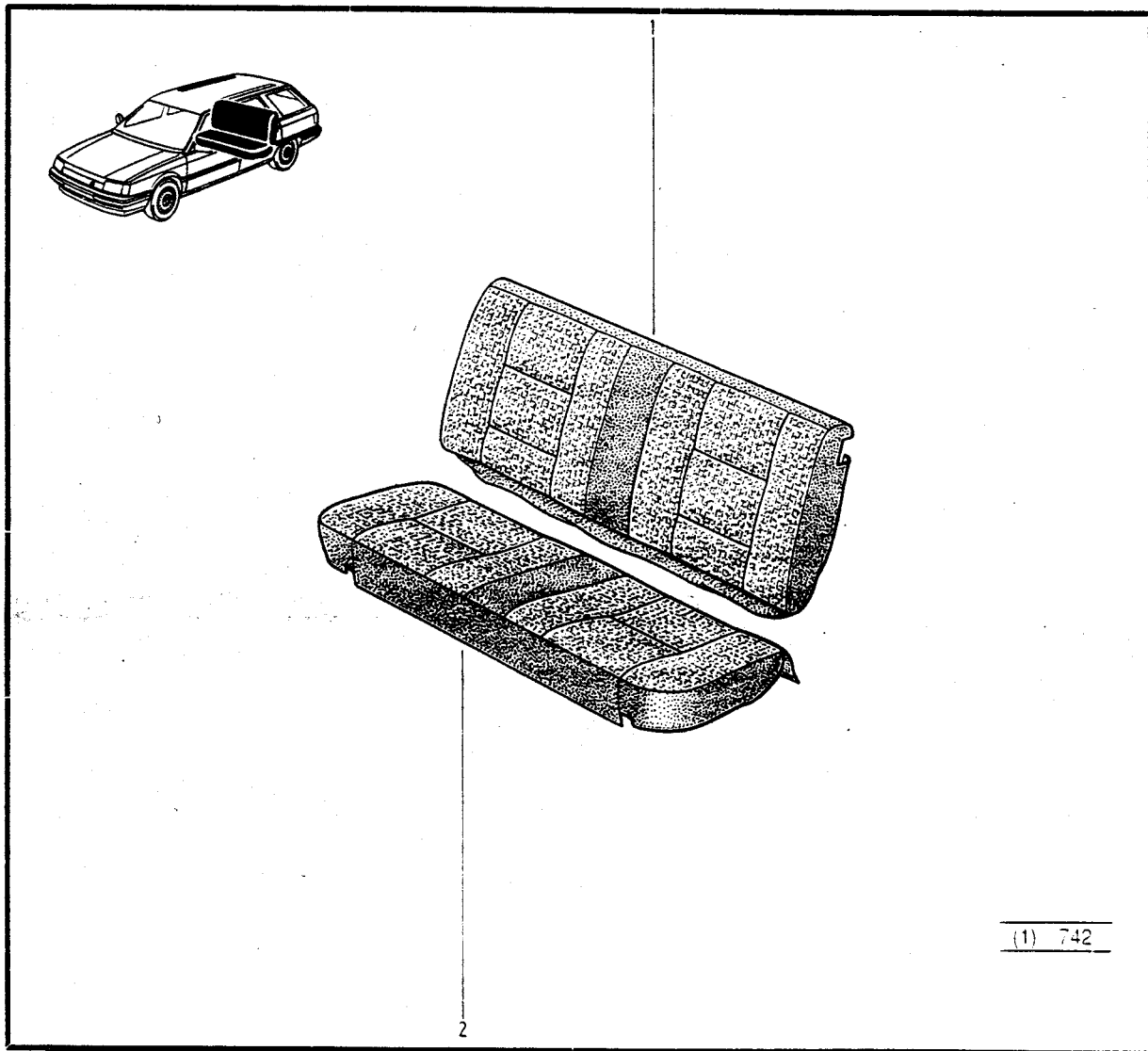

(1) 742

(a)	K489	\leftrightarrow	n^2	1	\leftrightarrow	n^2
	K488	\leftrightarrow	n^2	1	\leftrightarrow	n^2
(b)	L489	\leftrightarrow	n^2	1	\leftrightarrow	n^2
	L488	\leftrightarrow	n^2	1	\leftrightarrow	n^2



78.10.3

P.P

78.10.3

P.R. 1233



- 1- 77 02 220 308 [22] (1)
- 77 02 215 809 [5] (2)
- 2- 77 02 220 305 [22] (1)
- 77 02 215 807 [5] (2)
- 3- 77 02 220 303 [22] (1)
- 77 02 215 805 [5] (2)

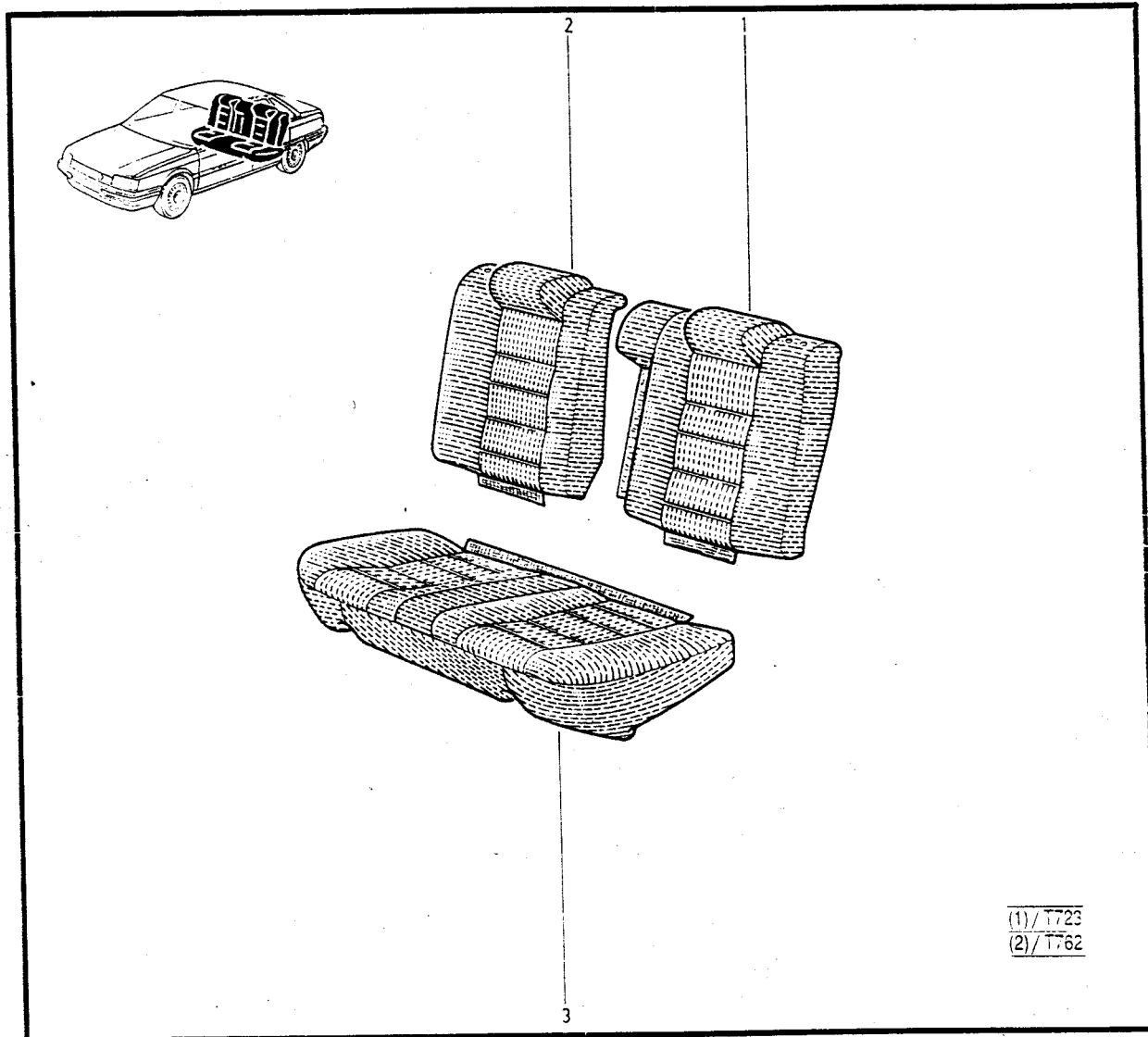

- L48S
- L48X
- L48K
- L48Y
- L48Z



78.10.4

P.R. 1233

- 1- 77 02 220 316 ~~(a)~~ (a)
- 77 02 220 312 ~~(b)~~ (b)
- 2- 77 02 220 314 ~~(a)~~ (a)
- 77 02 220 303 ~~(b)~~ (b)

78.10.4

P.R. 1233

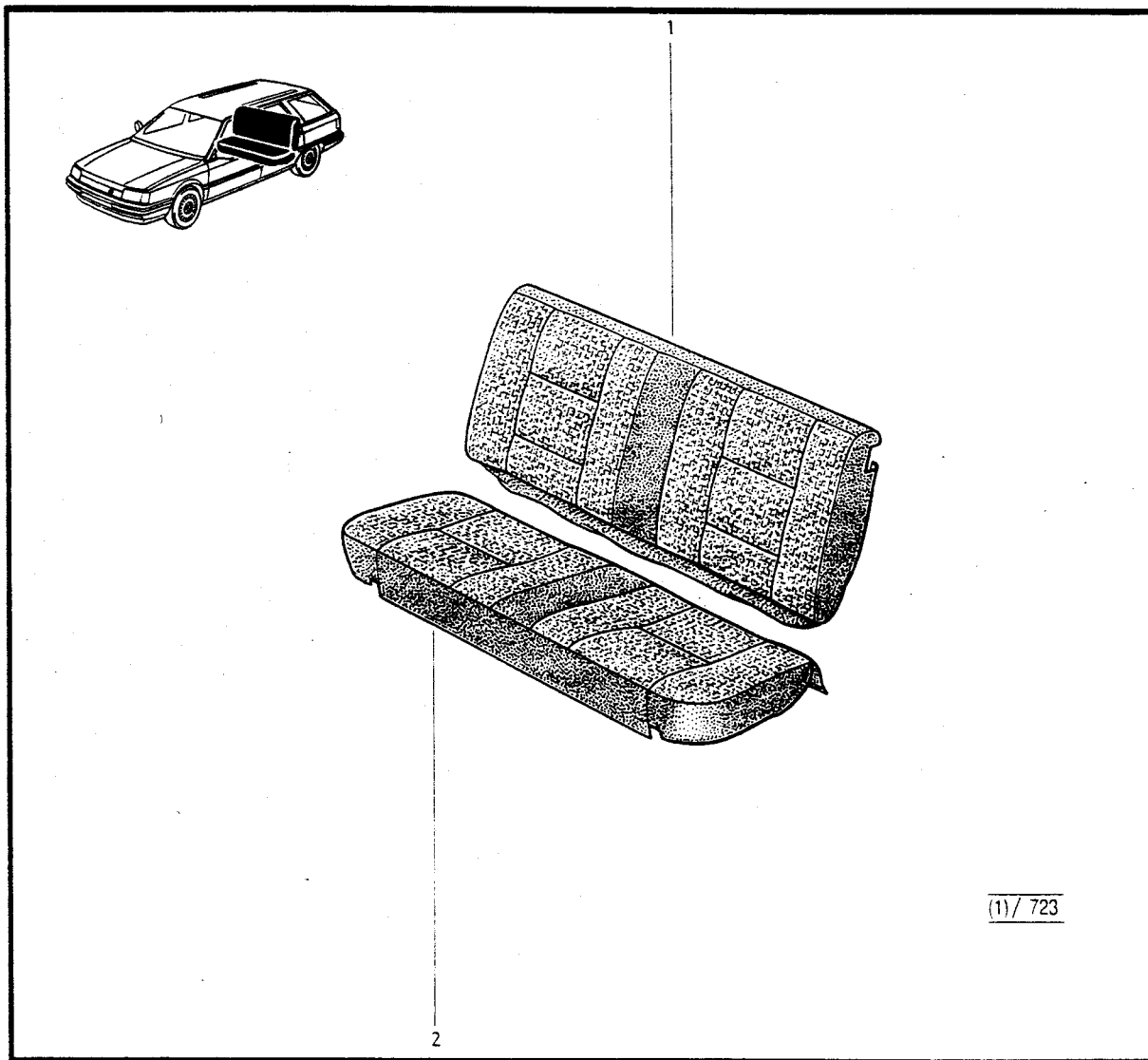

(1) / 723

(a) / K48G 202 - K487 089
(b) / L48G 202



78 . 25

P.R. 1233

L

78 . 25

P.R. 1233



- 1- 77 02 212 192 (2) (1) +
- 77 02 215 380 (2) (1)
- 2- 77 02 212 187 (2) (1) +
- 77 02 215 375 (2) (1)
- 3- 77 02 212 180 (2) (1) +
- 77 02 215 378 (2) (1)
- 4- 77 02 212 175 (2) (1) +
- 77 02 215 371 (2) (1)
- 5- 77 02 212 202 (2) (1)
- 6- 77 02 212 197 (2) (1)

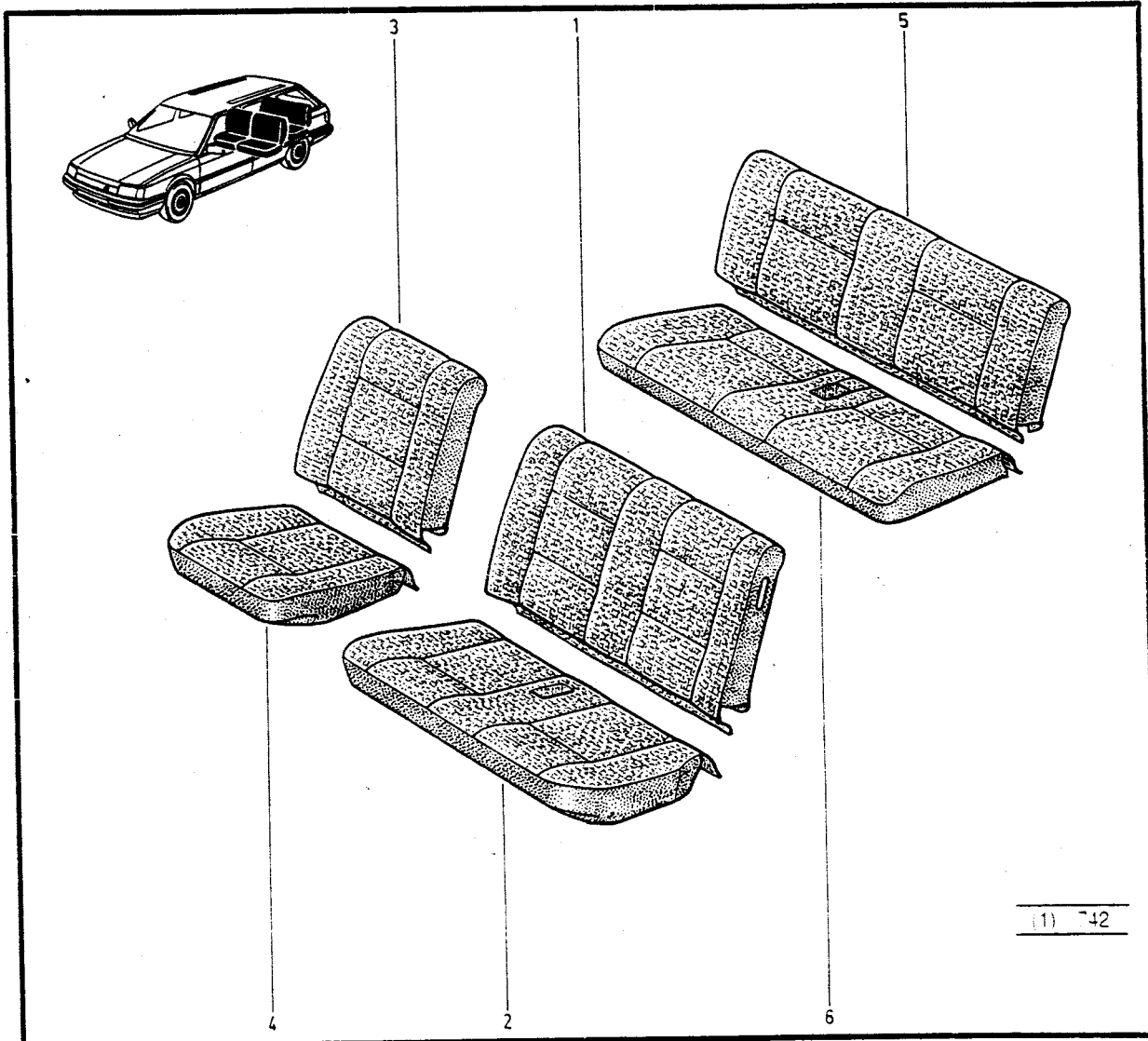

(1) 742



78.26
P.R. 1233



78.26
P.R. 1233



- 1- 77 02 220 331 [22] (1)
- 2- 77 02 220 330 [22] (1)
- 3- 77 02 220 327 [22] (1)
- 4- 77 02 220 326 [22] (1)
- 5- 77 02 220 334 [22] (1)
- 6- 77 02 220 333 [22] (1)

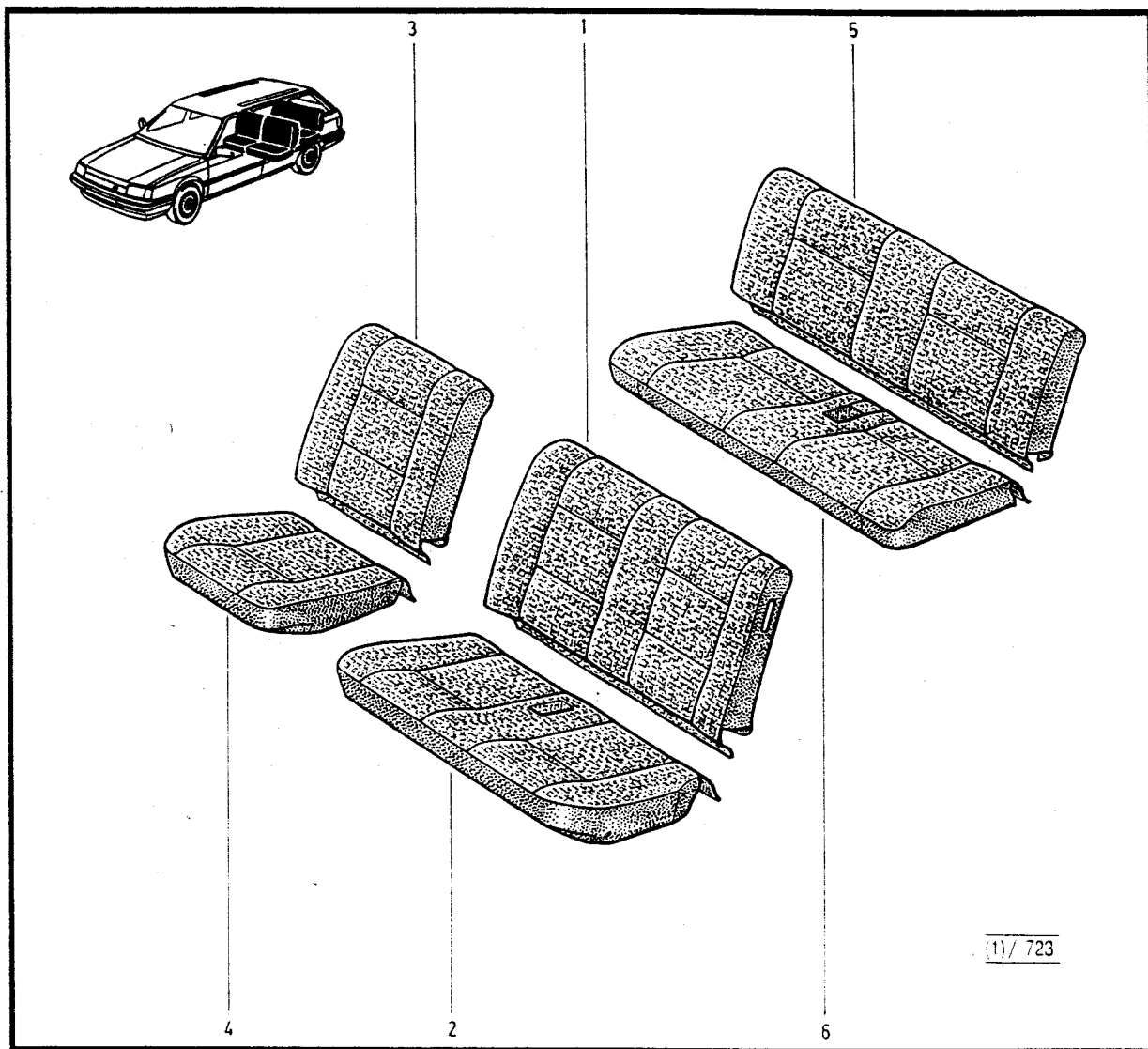

K48Y 092	⇄	n²	1 ⇄ n²
K48X 210	⇄	n²	1 ⇄ n²



79.01
P.R. 1233

79.01
P.R. 1233



- 1- 77 02 208 398 [5] (1)(2)
- 77 02 213 358 [2] (1)
- 2- 77 02 208 408 [5] (1)(2)
- 77 02 213 366 [2] (1)
- 3- 77 00 800 371 [5]
- 4- 77 00 788 440
- 5- 77 02 215 119 [2] (1)(a)(2)
- 77 02 215 117 [2] (1)(b)(2)

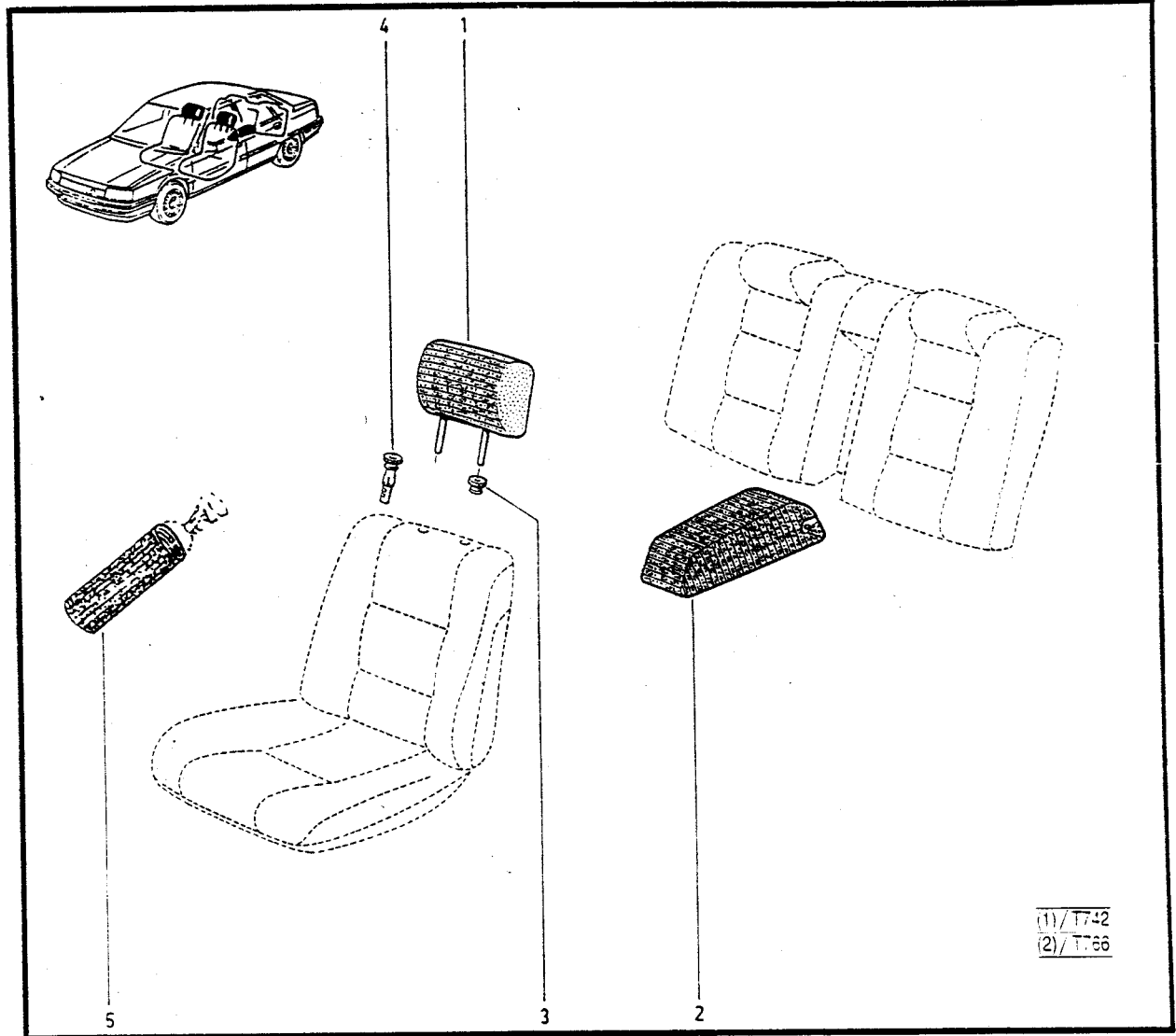

(1) / T742
(2) / T766

(a) / K48G 202 - L48G 202 - K488 202 - L488 202
(b) / K48S 210 - L48K 208/9 - L48S 208 - L48X 208 - K48X 210

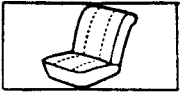

79 . 02

P.R. 1233

- 1- 77 02 220 245 [22] (1)
- 77 02 208 398 [5] (2)
- 2- 77 00 788 440
- 3- 77 00 800 371
- 4- 77 02 220 309 [22] (1) (a)
- 77 02 220 323 [22] (1) (b)
- 77 02 208 408 [5] (2)
- 5- 77 02 215 117 [22] (2)(1)

79 . 02

P.R. 1233

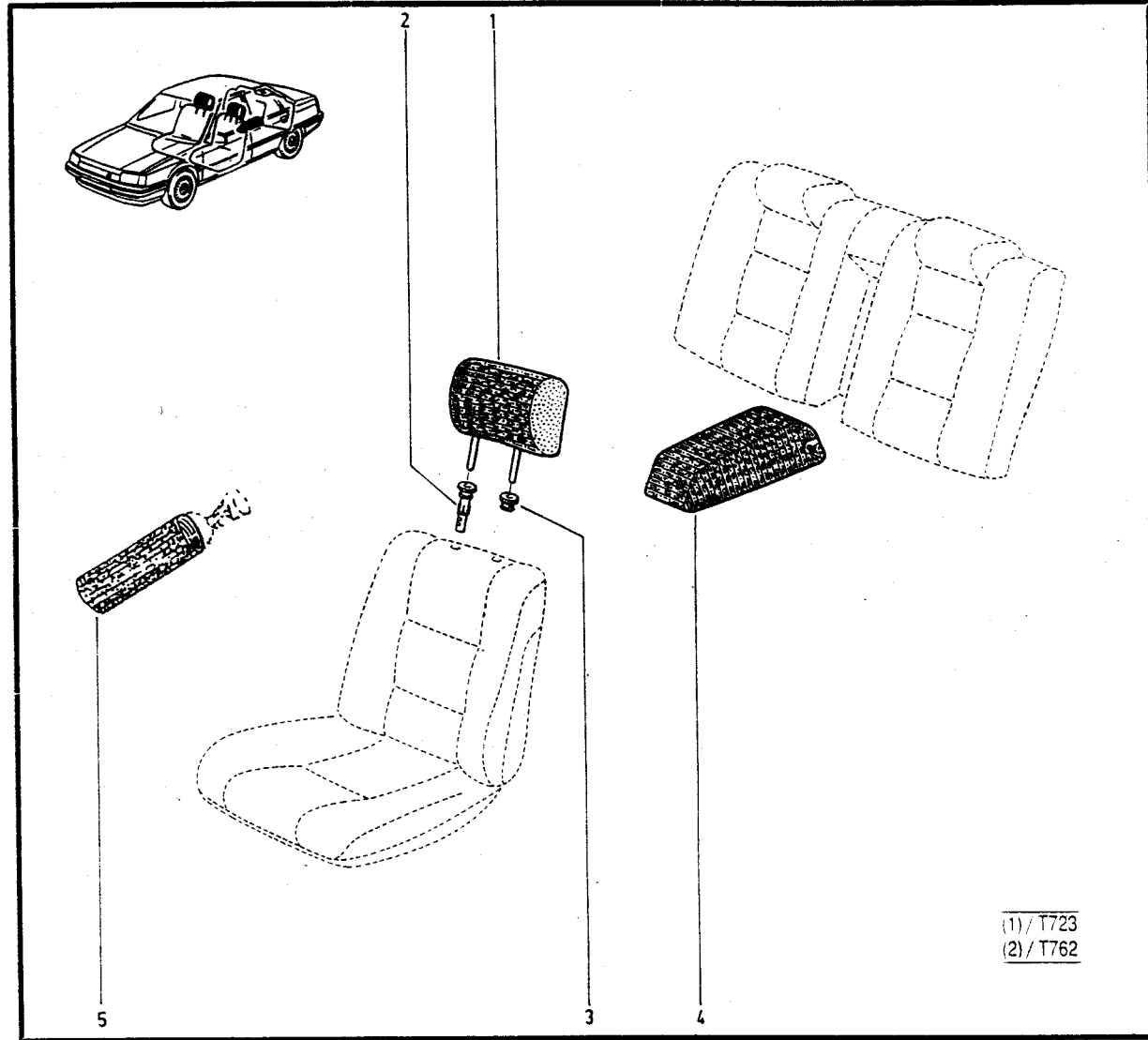

(1) / T723
 (2) / T762

L48S 090
 (a) / L48X 208
 L48K 209
 (b) K48Y 090

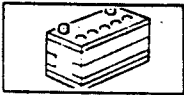

80.01
P.R. 1233

- 1- 77 00 764 750
- 2- 77 03 080 032
- 3- 77 02 212 414
- 4- 77 03 019 139
- 5- 77 02 212 413

80.01
P.R. 1233

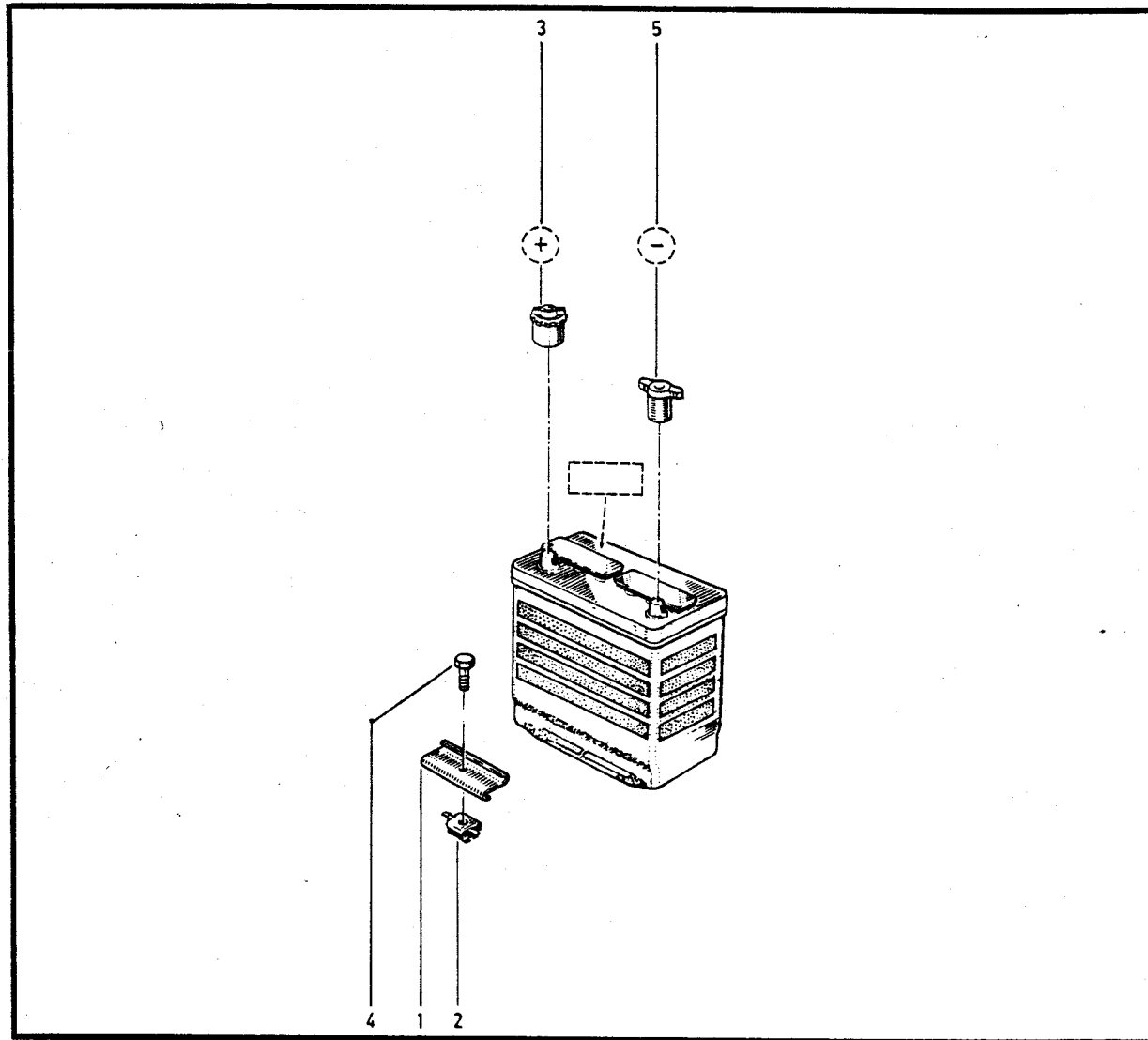
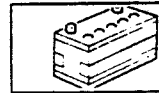

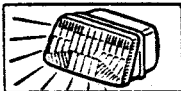

80.20

P.R. 1233

- 1- 77 01 034 132 (b)
- 77 01 034 136 (a)
- 2- 77 01 034 133 (b)
- 77 01 034 137 (a)
- 3- 77 01 032 943
- 4- 77 01 029 906
- 5- 77 05 098 059
- 6- 77 03 101 220

80.20

P.R. 1233

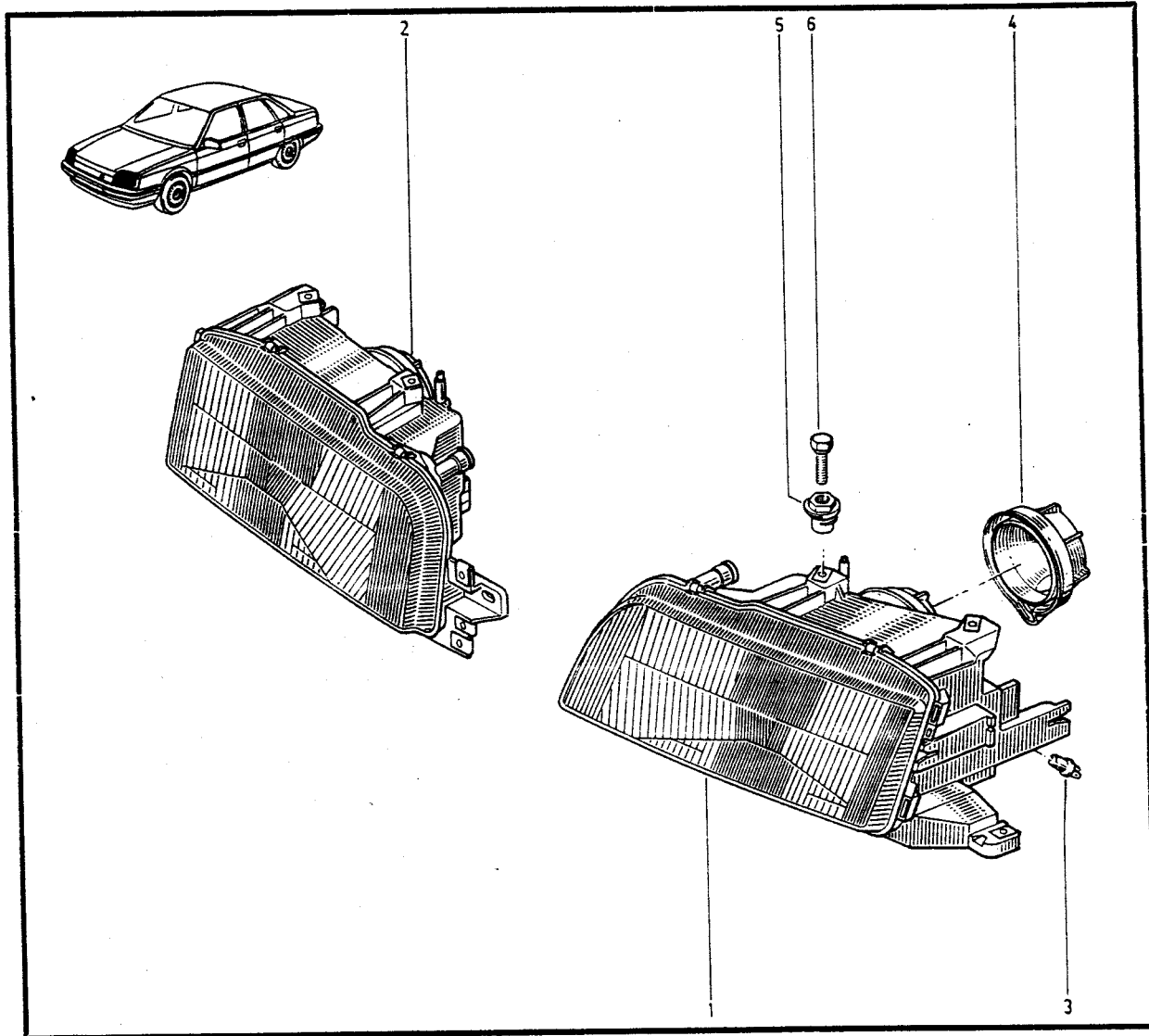
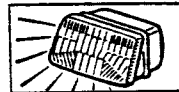

(a)	□	L48S ↔ n° 6087 ⇒ n°.....
		K48S ↔ n° 01002 ⇒ n°.....
L48Z - L48X - L48K - L48Y - K48X - K48Y		
(b)	■	L488 - L48G
		K488 - K48G - K487



80.25
P.R. 1233

ED

80.25
P.R. 1233



- 1 - 77 02 206 314 [3]
- 77 01 366 152 [1]
- 2 - 77 03 046 091
- 3 - 77 02 206 965

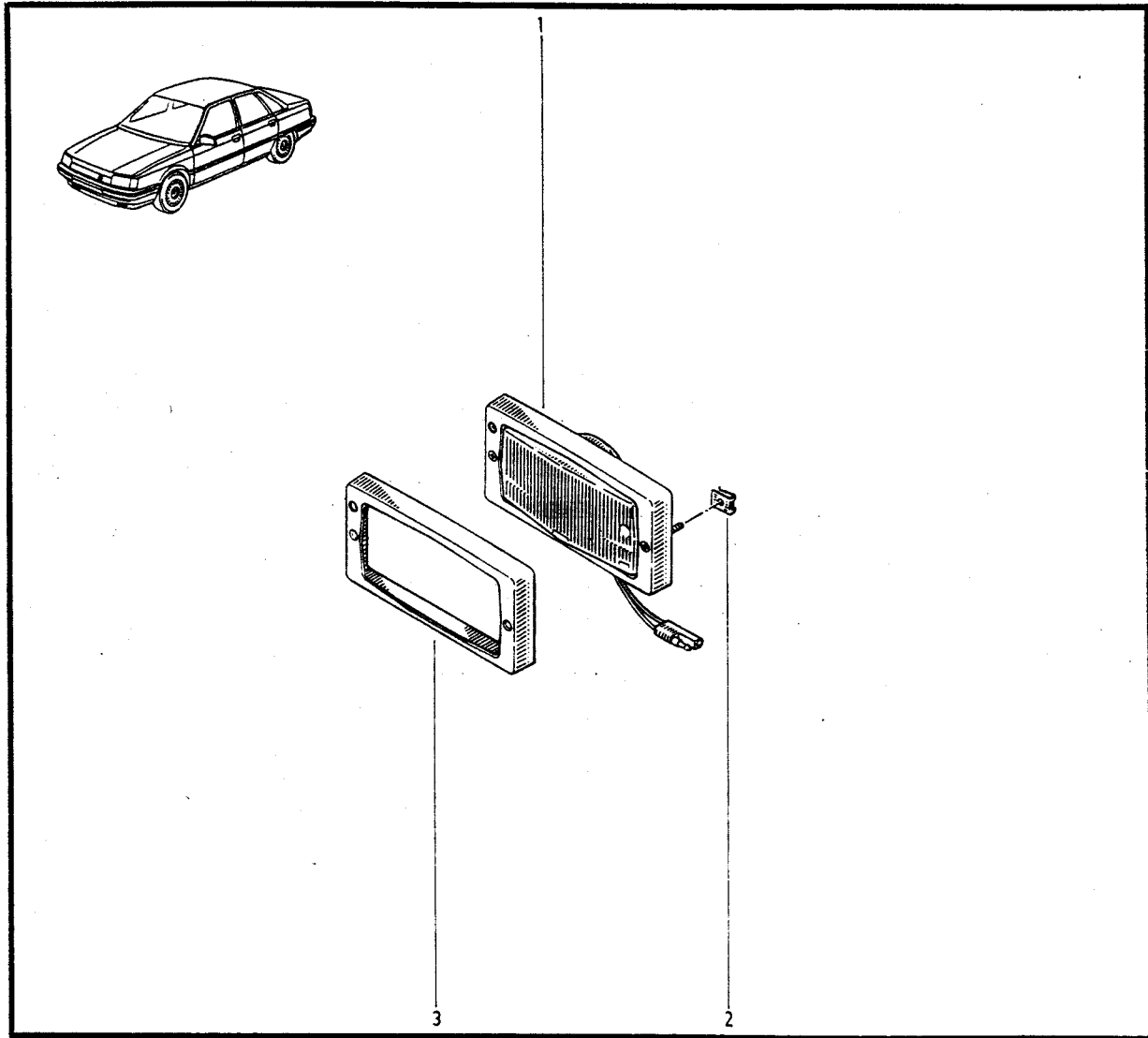

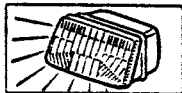

80.30

P.R. 1233



80.30

P.R. 1233



- 1- 77 00 824 486
- 2- 77 03 033 005
- 3- 77 00 776 177 [24]
- 77 00 776 179 [22]
- 4- 77 00 776 176 [24]
- 77 00 776 178 [22]

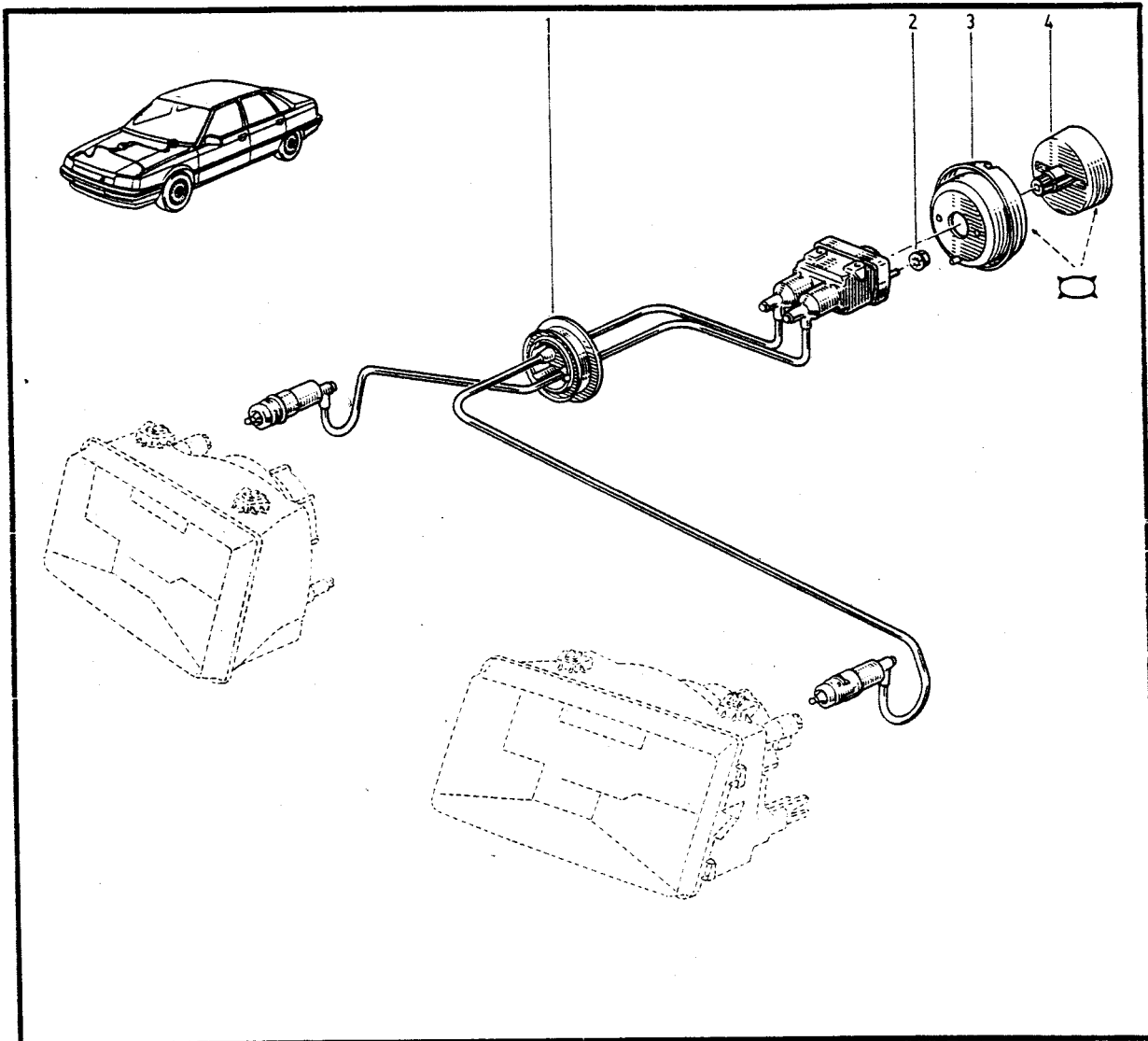

L48S	↔	n°	6087	⇨	n°
K48S	↔	n°	01003	⇨	n°
L48Z	↔	n°	1	⇨	n°
L48X - L48K - L48Y						
K48X - K48Y						

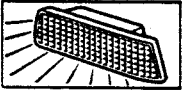

80 . 41

P.R. 1233

- 1-77 01 034 320
- 2-77 01 034 321
- 3-77 01 349 861

80 . 41

P.R. 1233

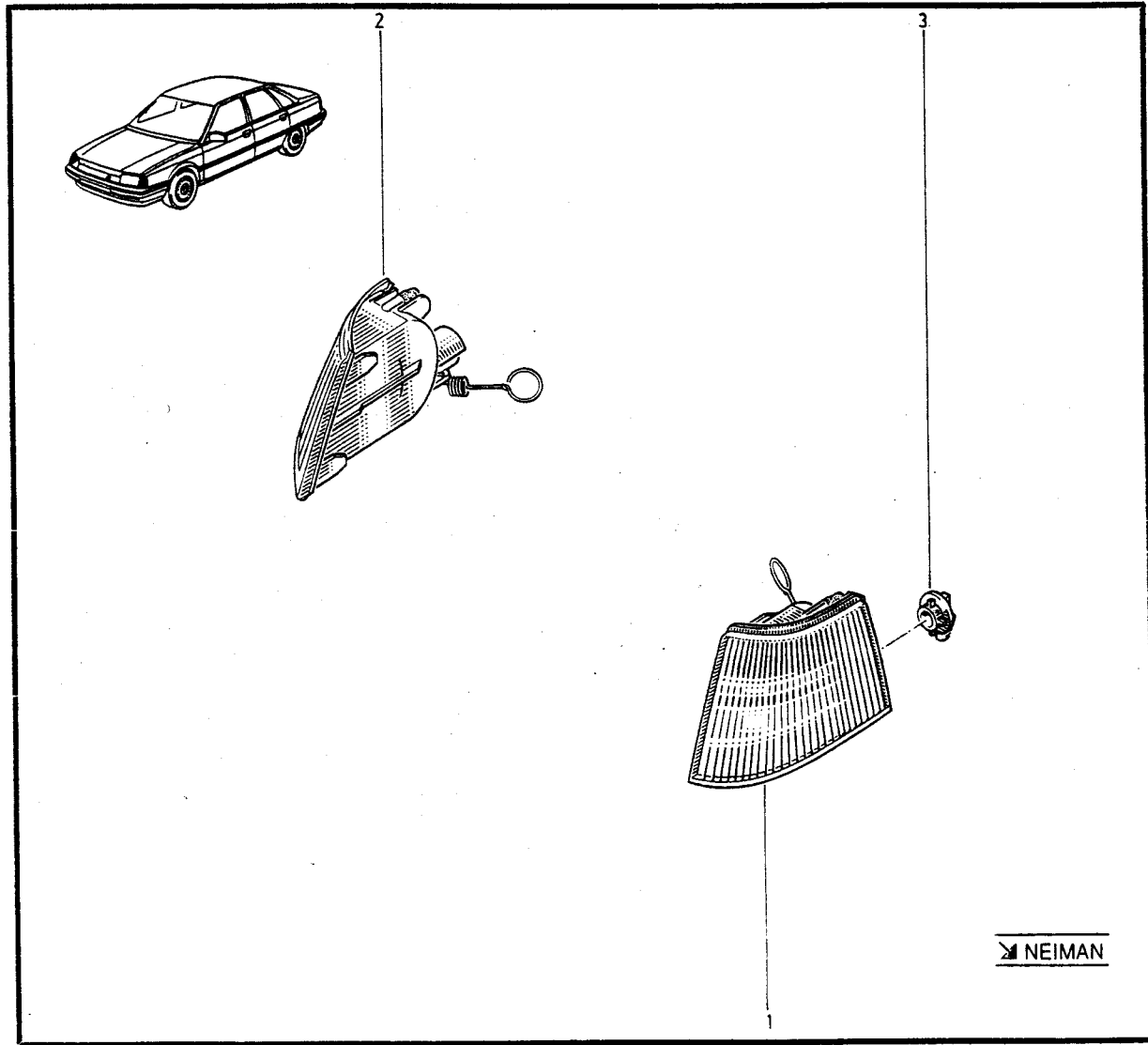
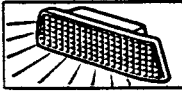

NEIMAN

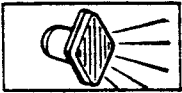

81 . 01

P.R. 1233

1 - 77 00 686 524
2 - 77 01 365 611

81 . 01

P.R. 1233

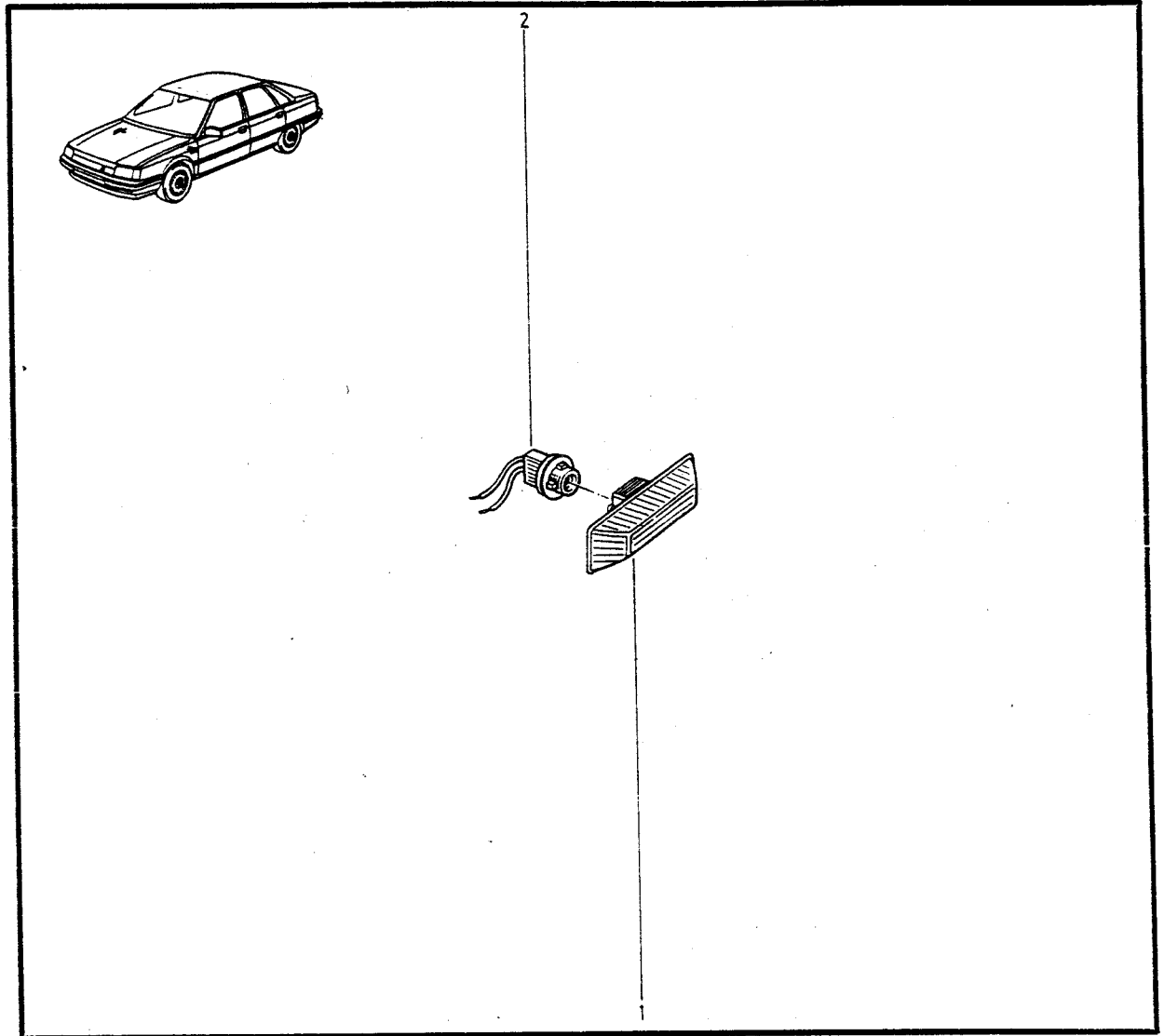
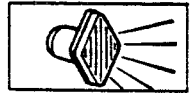

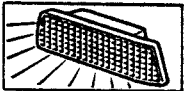

81.10

P.R. 1233

- 1- 77 00 792 874
- 2- 77 01 032 897
- 3- 77 00 792 895
- 4- 77 01 032 894
- 5- 77 00 792 875
- 6- 77 01 032 898
- 7- 77 00 792 904

81.10

P.R. 1233

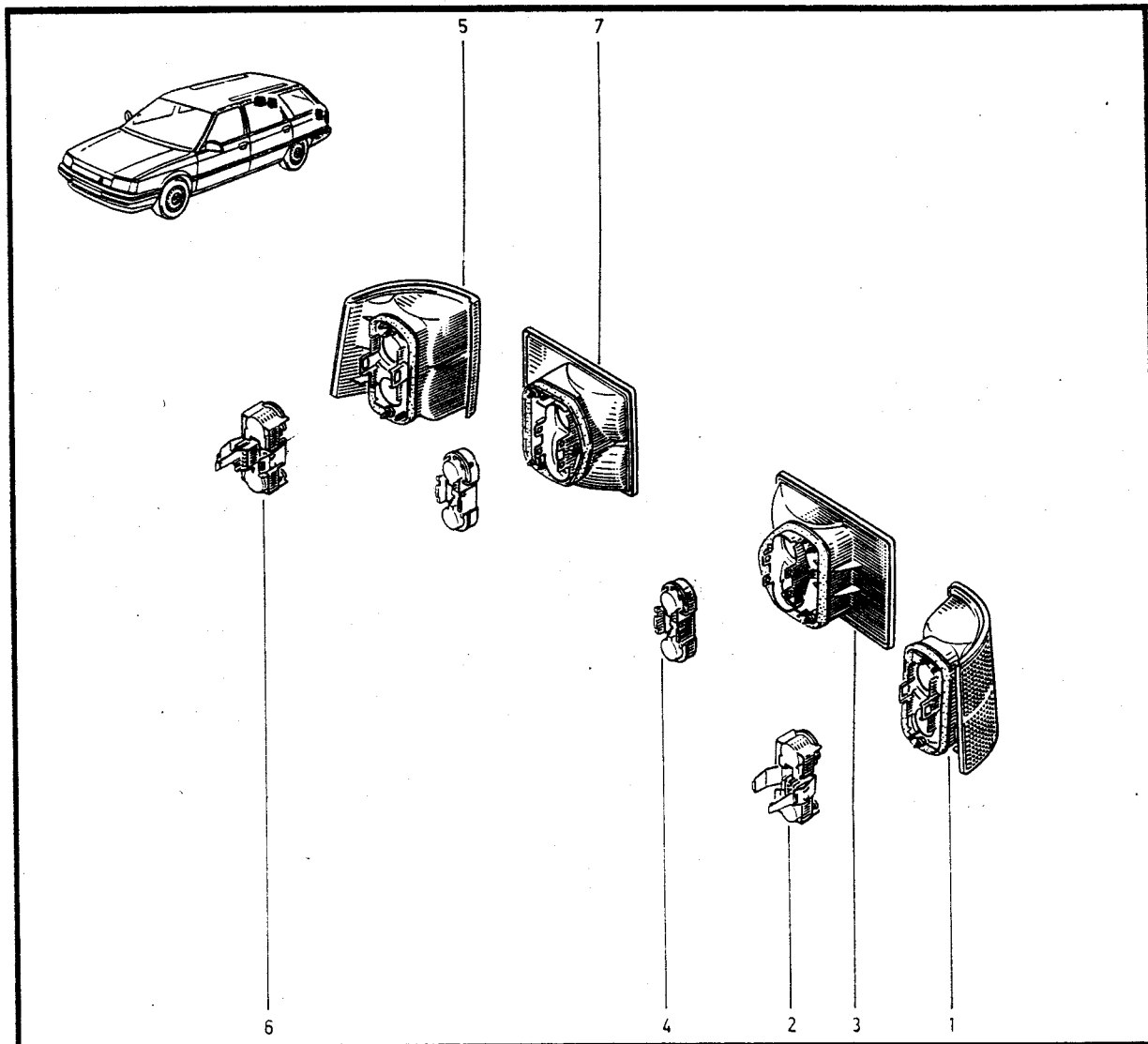
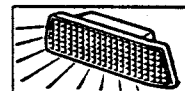

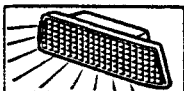

81.12

P.R. 1233

- 1- 77 00 773 235 [22]
- 77 00 773 236 [24]
- 2- 77 01 033 130

81.12

P.R. 1233

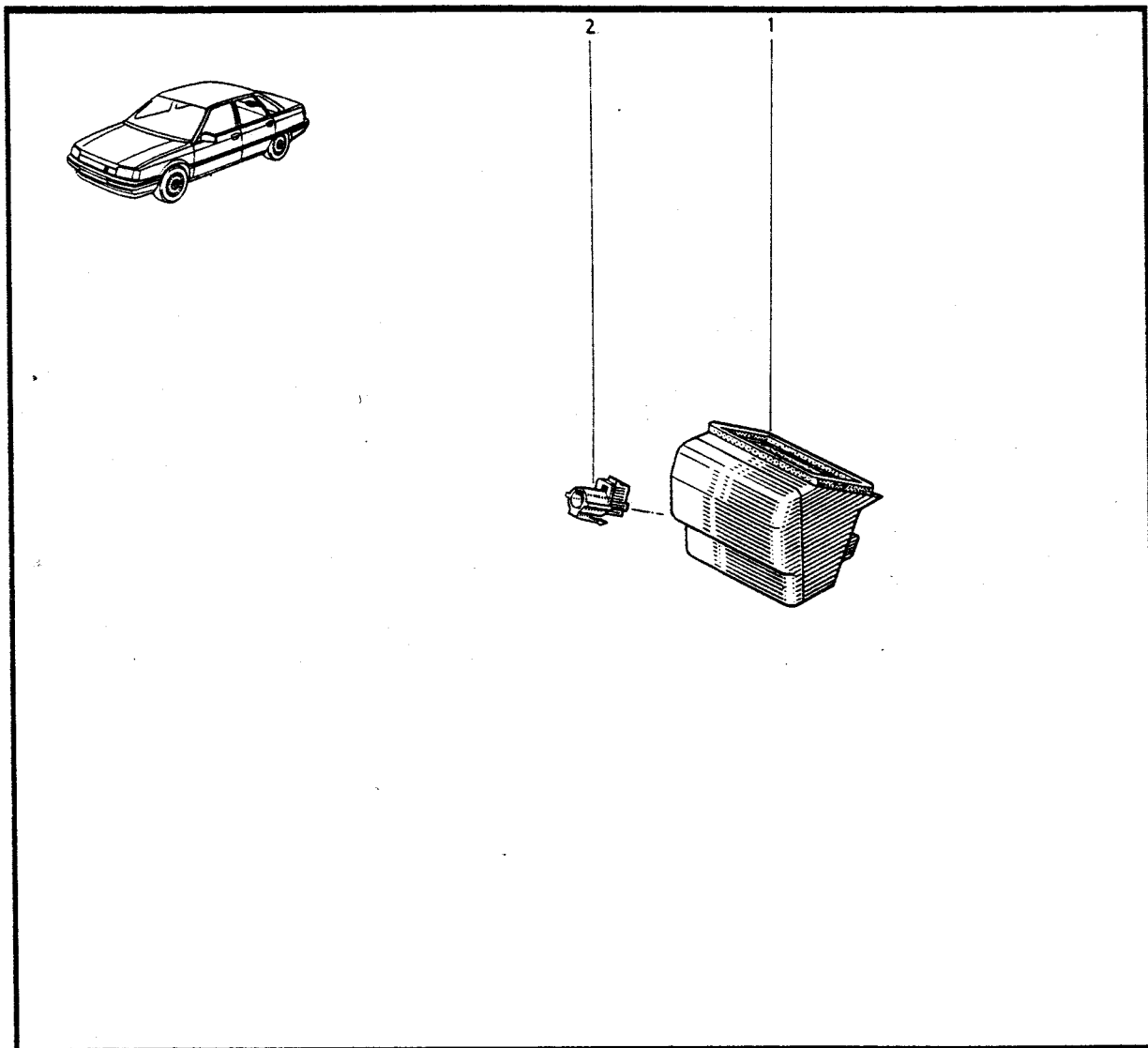
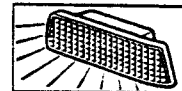

L48Z
L48K

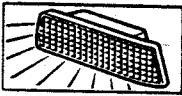

81.15

P.R. 1233

- 1 - 77 01 034 281
- 2 - 77 01 034 283
- 3 - 77 02 205 385
- 4 - 77 01 032 022
- 5 - 77 01 034 282
- 6 - 77 01 034 573

81.15

P.R. 1233

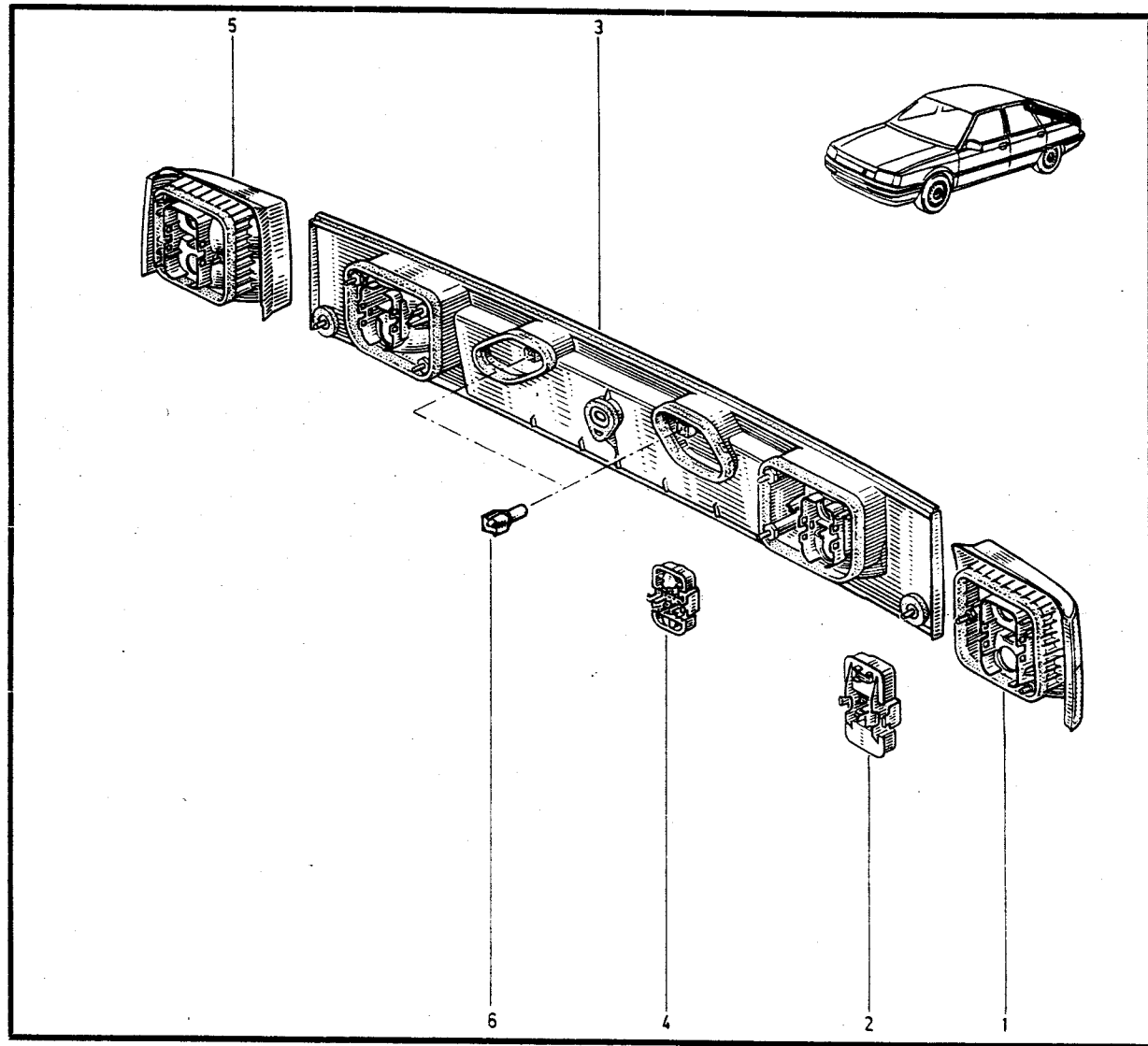
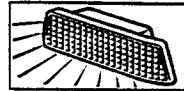

L48S	↔	n° 06087	⇒	n°
L488	-	L48Z	-	L48Y
L48G	-	L48K	-	L48X



81.20

P.R. 1233

1-77 01 366 060

81.20

P.R. 1233

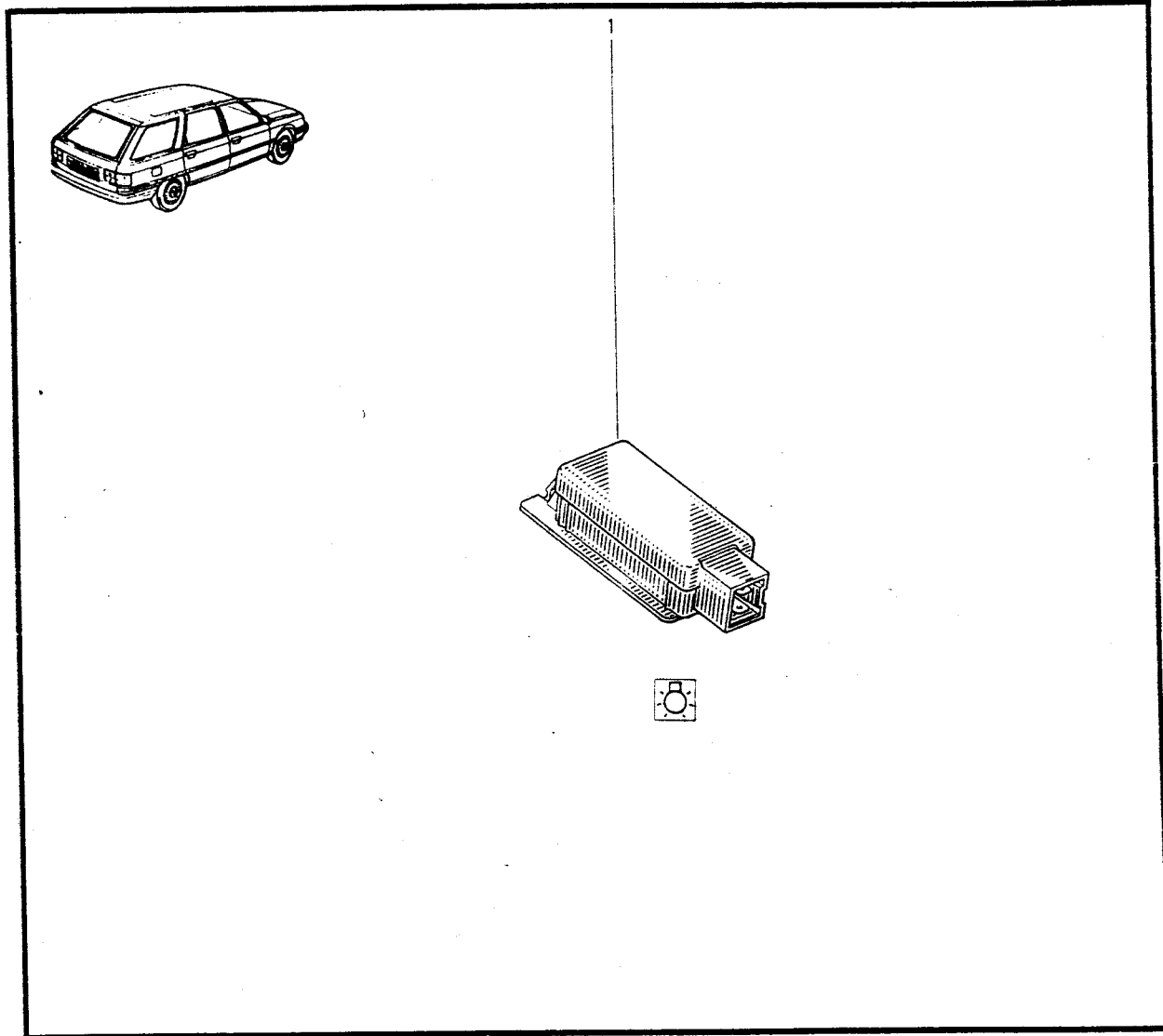

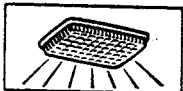

81.40

P.R. 1233

- 1- 77 01 366 150
- 2- 77 01 366 151
- 3- 77 01 366 136
- 4- 77 02 082 570 [21]
- 77 01 349 799 [24]
- 5- 77 02 072 066
- 6- 77 00 825 472
- 7- 77 00 772 596
- 8- 77 01 033 679
- 9- 77 00 811 152

81.40

P.R. 1233

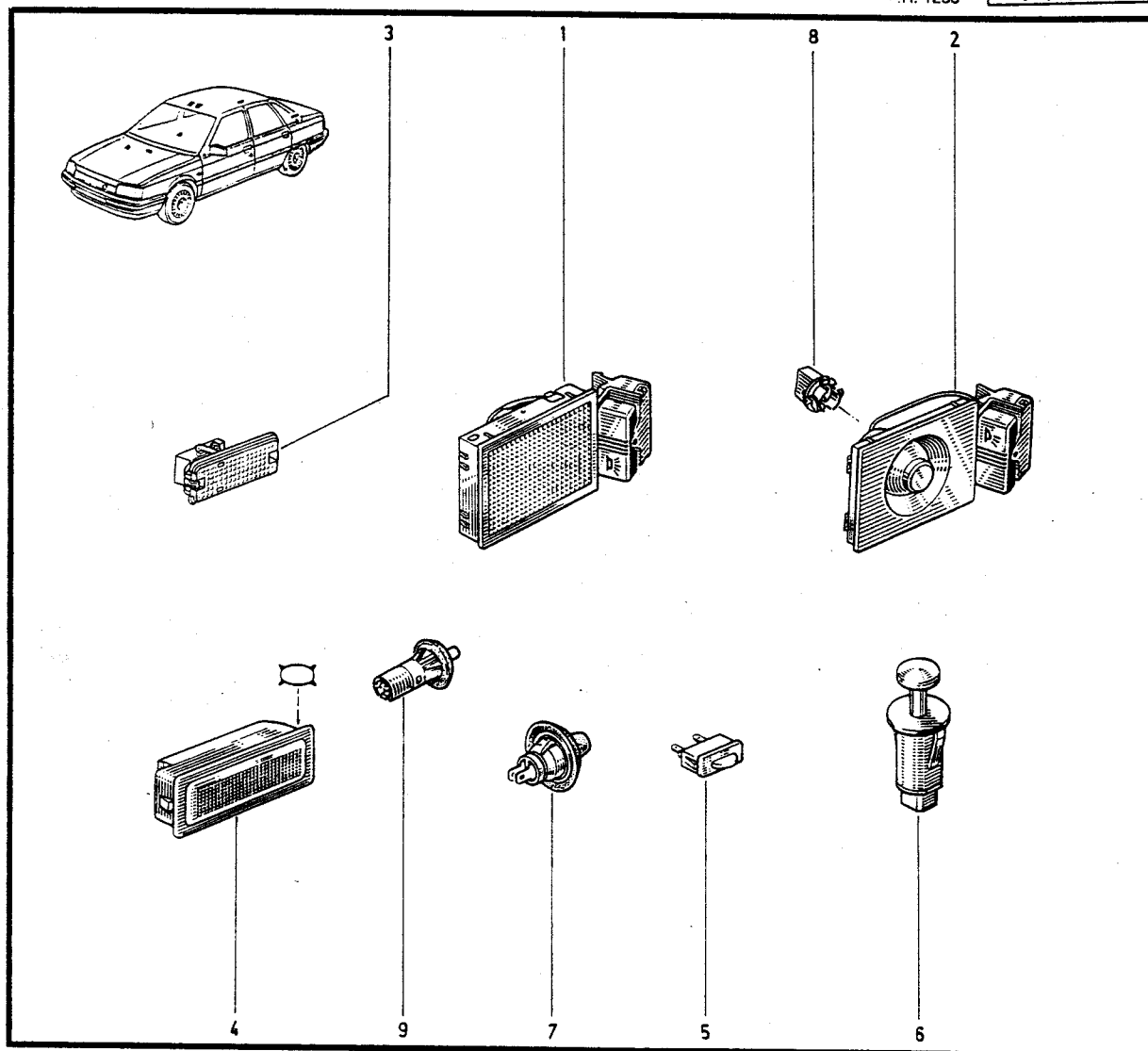

81.50

P.R. 1233

81.50

P.R. 1233

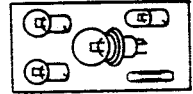
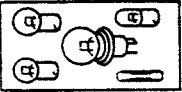

- 1 - 77 02 025 912 [3]
- 2 - 77 03 097 179
- 3 - 77 03 097 178
- 4 - 77 00 760 157
- 5 - 08 54 530 700
- 6 - 77 03 097 186 (X=9)
- 7 - 77 01 005 981 (X=7)
- 8 - 77 03 097 181
- 9 - 77 03 097 183
- 09 90 003 600
- 10 - 77 03 097 182 (X=9)
- 11 - 77 03 097 387
- 12 - 77 03 097 185
- 13 - 77 03 097 184
- 14 - 77 01 998 052 [4]
- 15 - 77 01 998 065 [4]
- 16 - 77 01 998 056 [4]
- 17 - 77 01 998 057 [4]
- 18 - 77 01 998 053 [6]
- 19 - 77 01 998 058 [7]
- 20 - 77 01 998 059 [11]
- 21 - 77 01 998 054 [3]
- 22 - 77 01 998 060 [9]
- 23 - 77 01 400 250
- 24 - 77 03 097 516

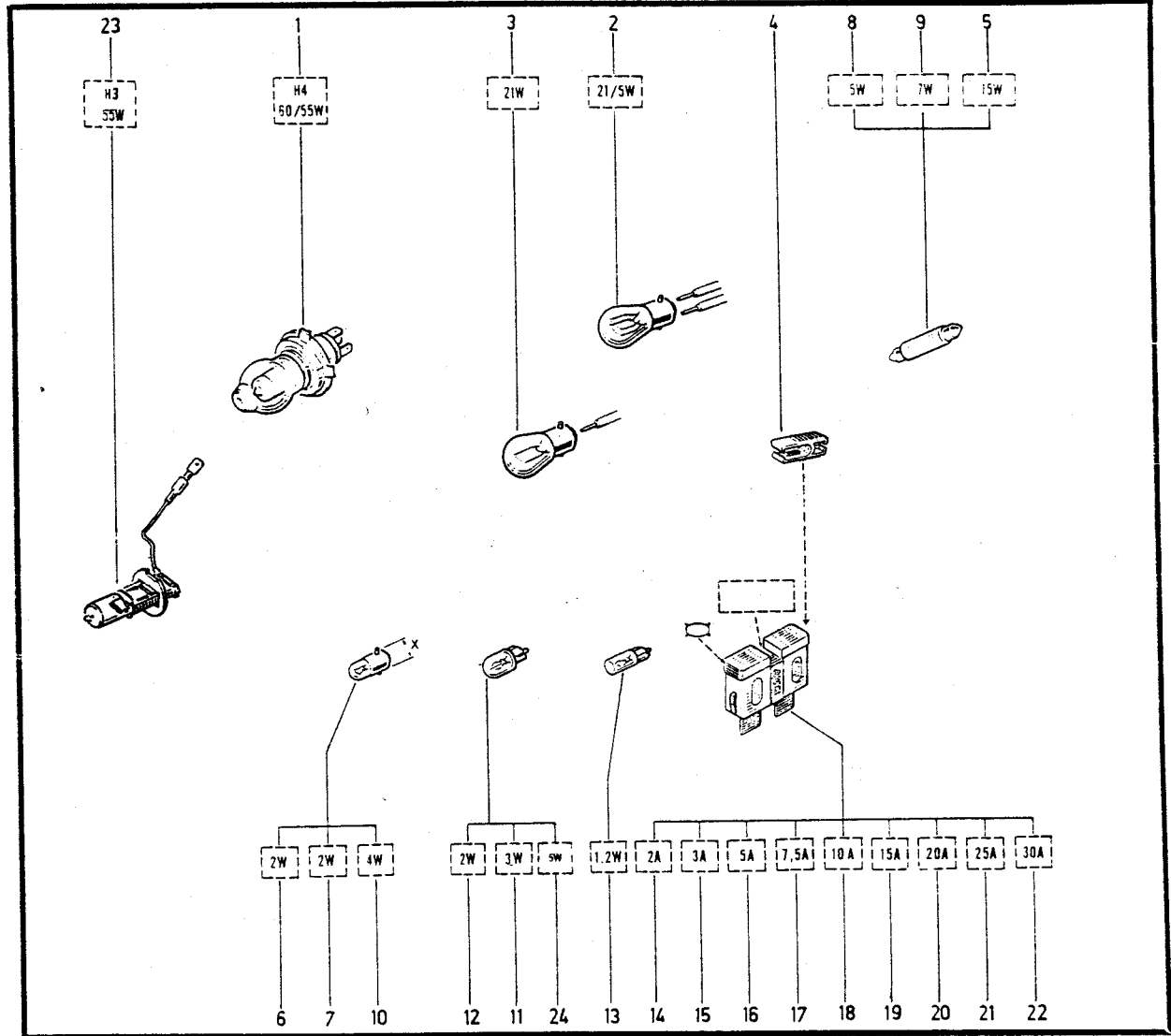



82.01
P.R. 1233



82.01
P.R. 1233

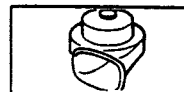

1-77 02 205 361
2-77 02 205 360

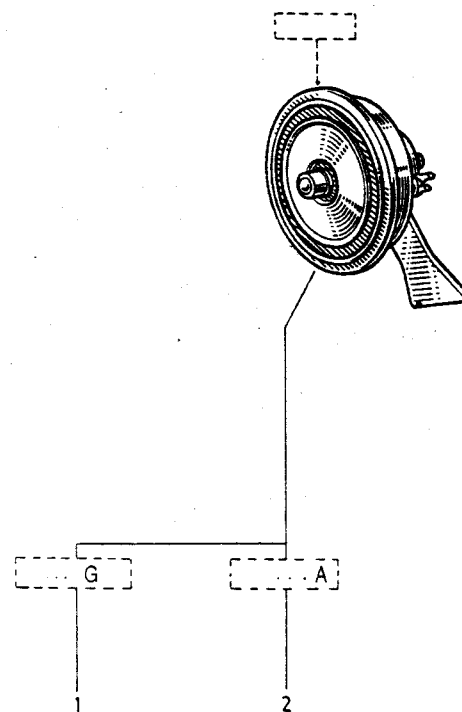
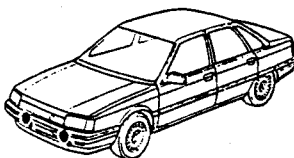

KOBLA

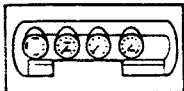

83.01

P.R. 1233

83.01

P.R. 1233

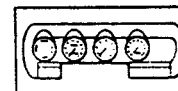

- 1- 77 00 797 032
- 2- 77 01 035 151
- 3- 77 01 030 941
- 4- 77 01 021 647
- 5- 77 01 035 152
- 6- 77 01 035 150
- 7- 77 01 035 155
- 8- 77 01 035 153
- 9- 77 01 035 115
- 10- 77 01 035 111
- 11- 77 01 035 112

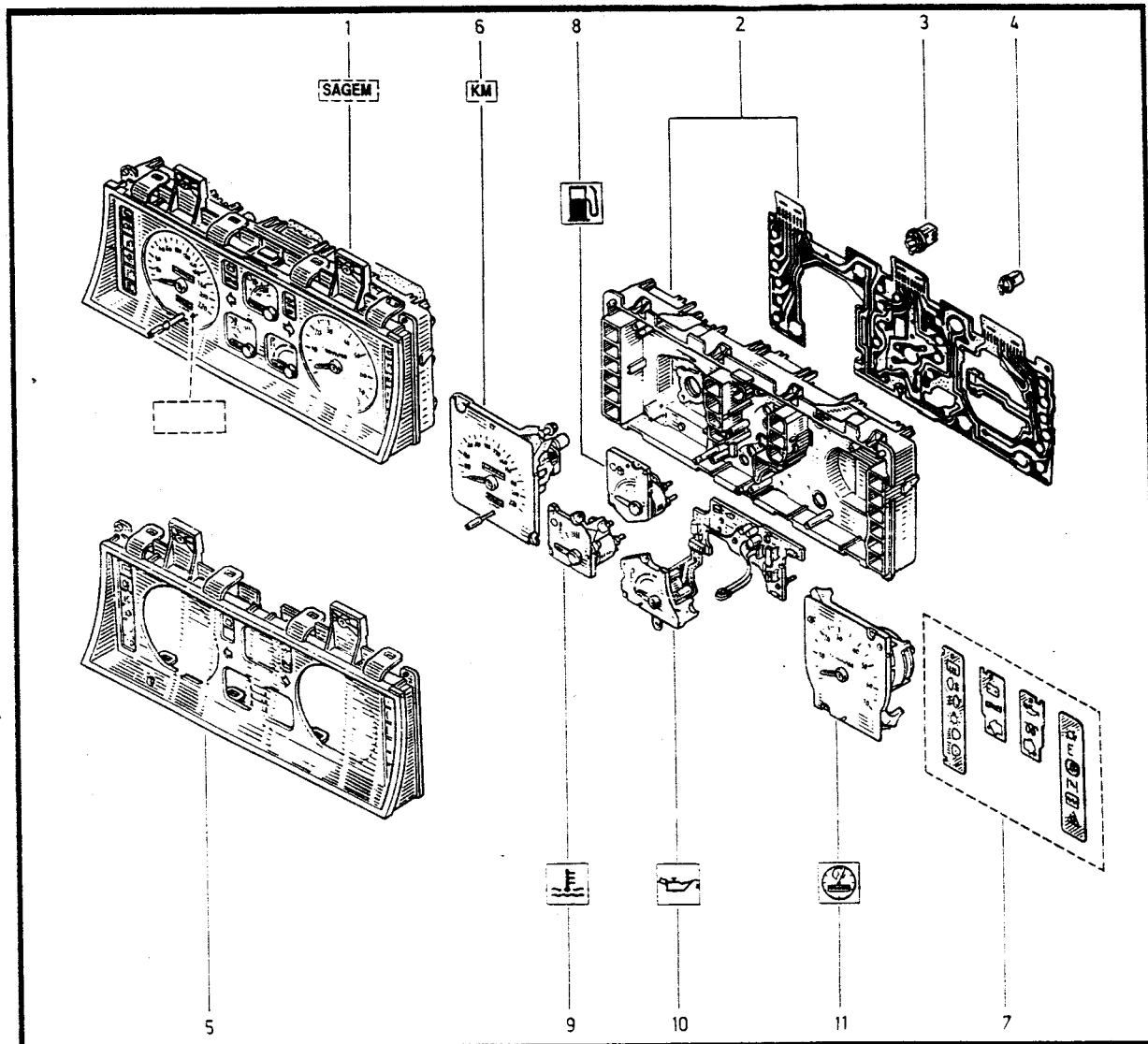

L488 - L48G
K488 - K48G - K487

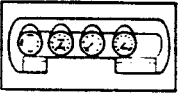

83.02

P.R. 1233

- 1 - 77 00 797 032
- 2 - 77 01 034 454
- 3 - 77 01 030 941
- 4 - 77 01 021 647
- 5 - 77 01 034 457
- 6 - 77 01 034 443
- 7 - 77 01 202 715
- 8 - 77 01 034 450
- 9 - 77 01 033 730
- 10 - 77 01 034 451
- 11 - 77 01 034 447

83.02

P.R. 1233

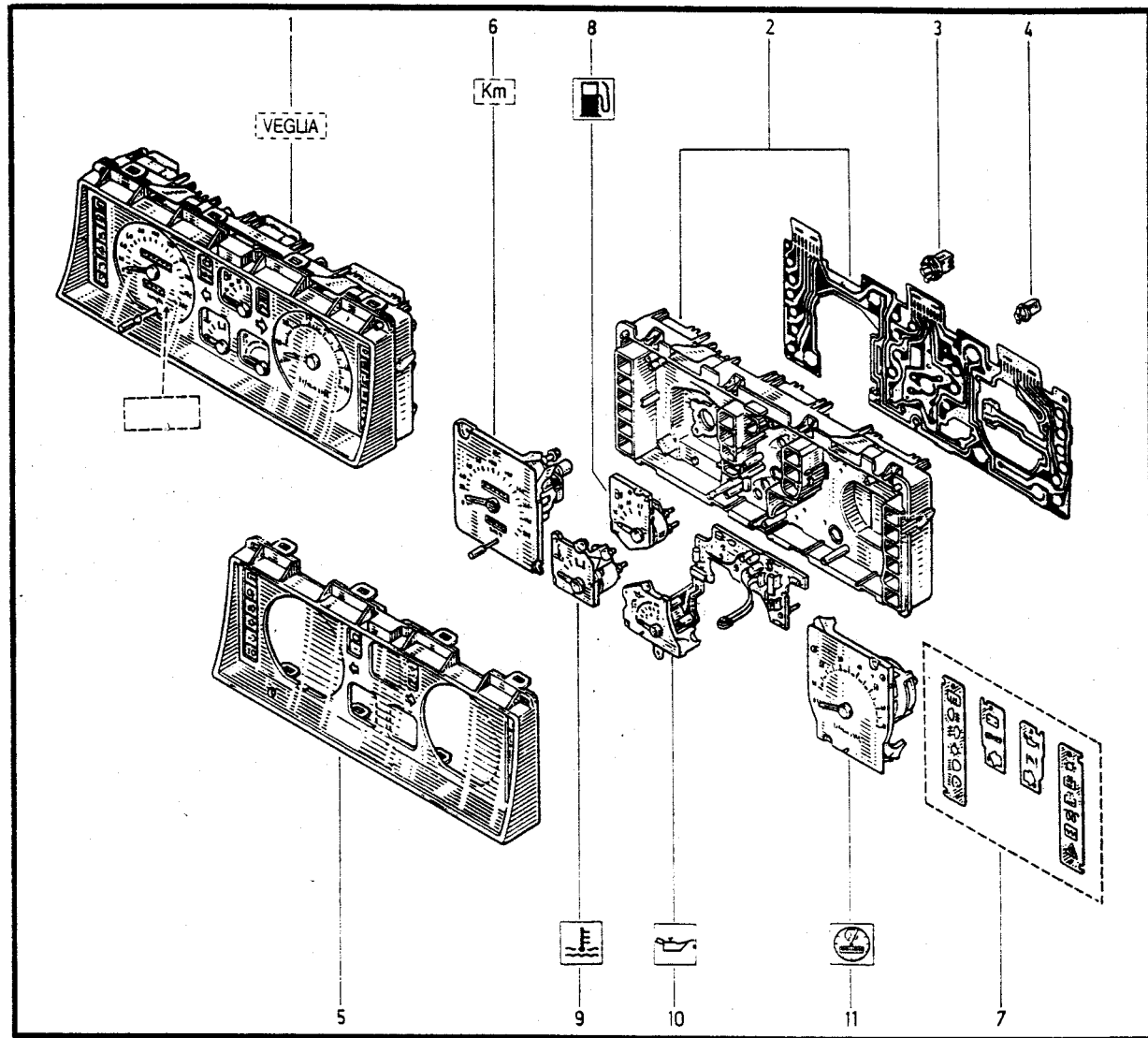
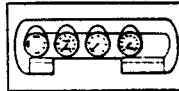

L488 - L48G
K488 - K48G - K487

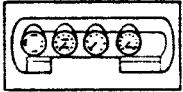

83.05

P.R. 1233

- 1-77 00 812 865
- 2-77 01 203 496
- 3-77 01 035 254
- 4-77 01 021 647
- 5-77 01 030 941
- 6-77 01 035 263
- 7-77 00 788 452
- 8-77 01 035 269
- 9-77 01 035 268
- 10-77 01 035 259
- 11-77 01 035 255
- 12-77 01 203 498

83.05

P.R. 1233

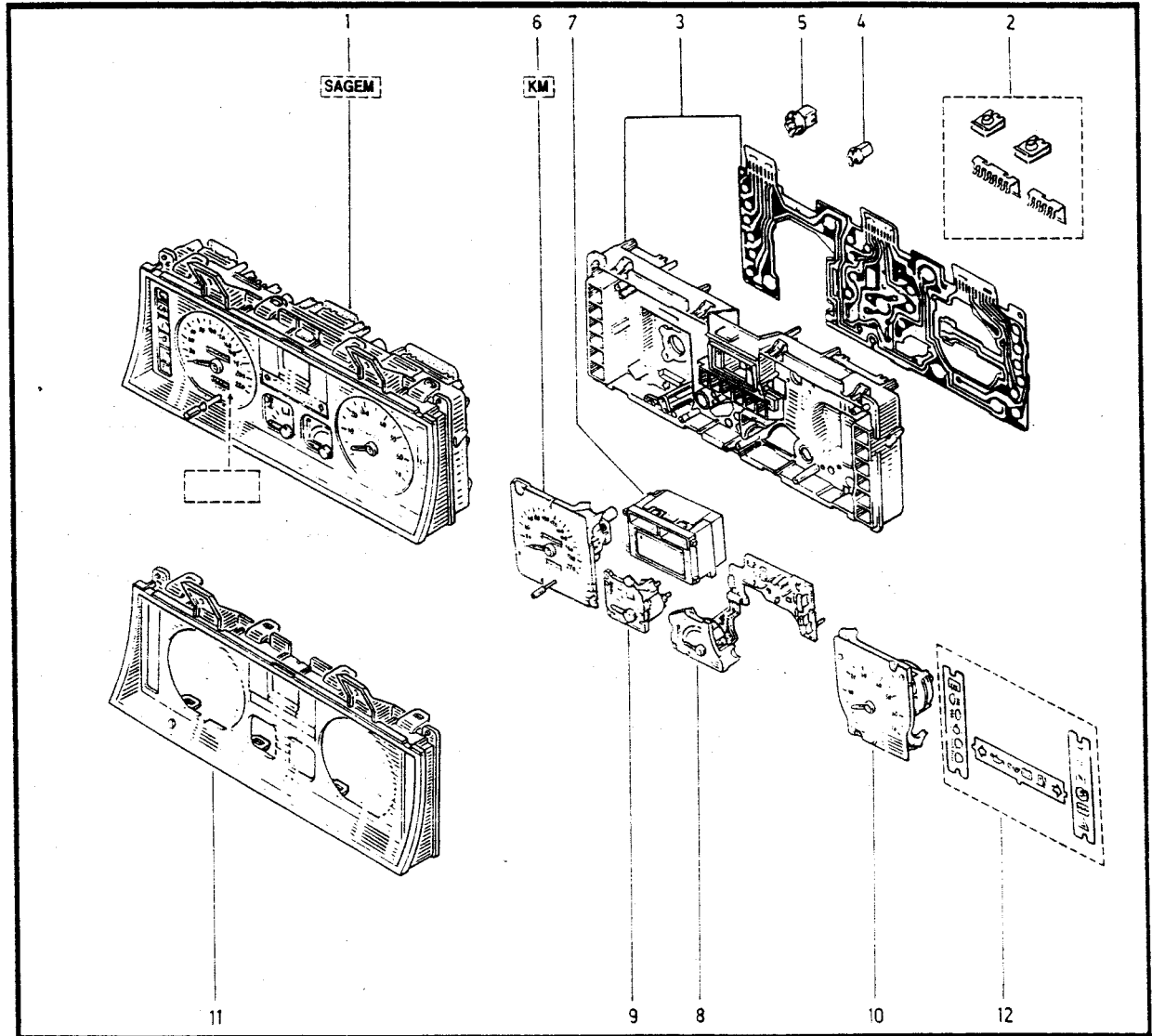
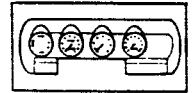

L48S - L48Z - L48Y

L48K - L48X

K48S - K48Y

K48X

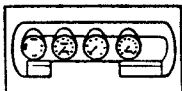

83.06

P.R. 1233

- 1-77 00 812 865
- 2-77 01 033 414
- 3-77 01 034 455
- 4-77 01 021 647
- 5-77 01 030 941
- 6-77 01 034 446
- 7-77 00 788 452
- 8-77 01 034 452
- 9-77 01 033 753
- 10-77 01 034 447
- 11-77 01 034 458
- 12-77 01 202 715

83.06

P.R. 1233

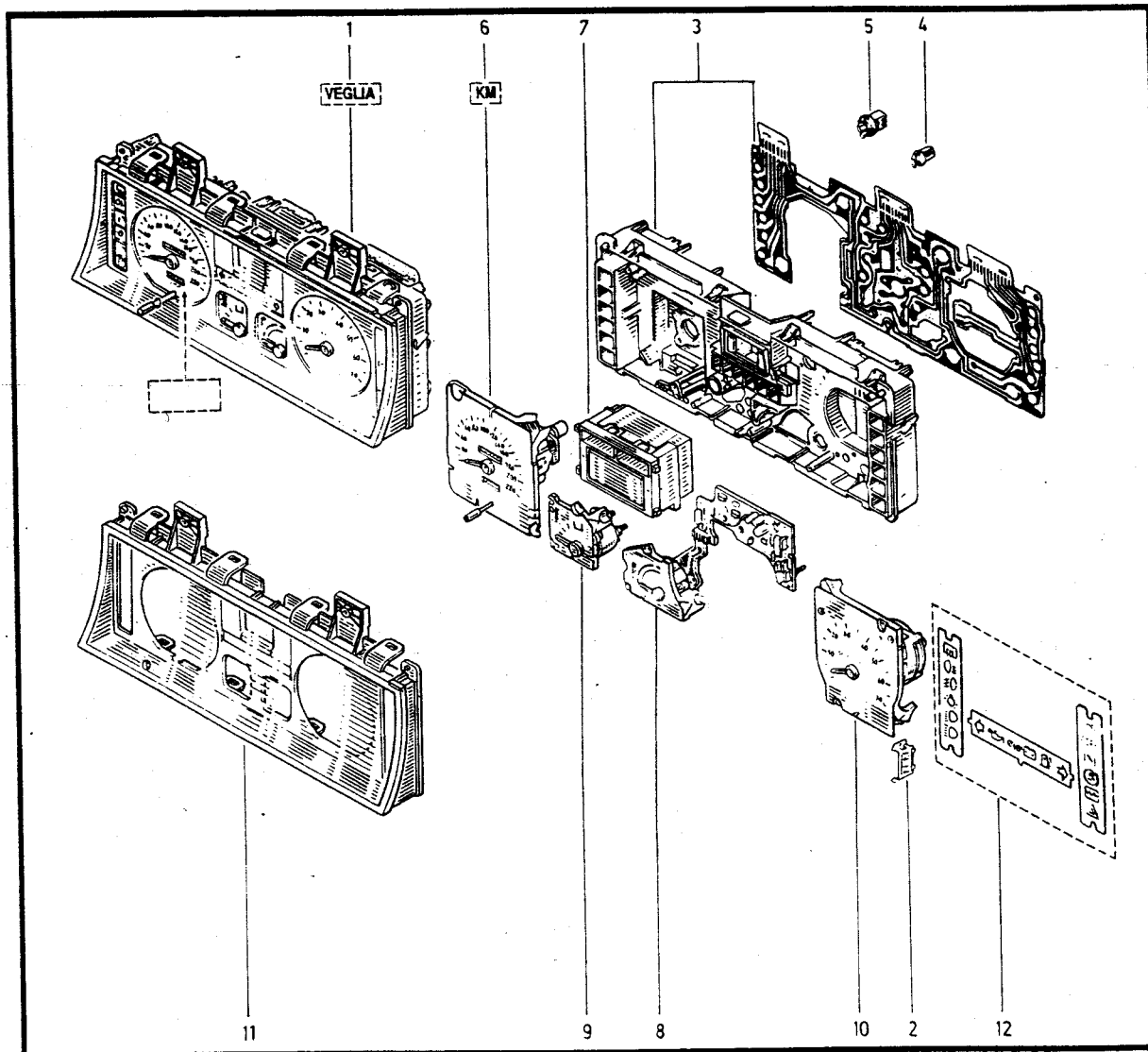
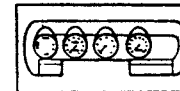

L48S - L48Z - L48Y
L48K - L48X
K48S - K48Y
K48X



83.10

P.R. 1233

83.10

P.R. 1233



- 1- 77 00 772 075 (a)
- 77 00 787 239 (b)
- 2- 77 02 205 376 ↔(a)(c)†
- 77 00 790 984 ↔(a)(c)
- 3- 77 00 676 253
- 4- 77 03 079 146
- 5- 77 03 079 285
- 6- 77 02 205 285
- 7- 77 03 079 072
- 8- 77 02 205 374 ↔(b)(d)†
- 77 00 796 639 ↔(b)(d)
- 9- 77 02 205 443 (c)
- 77 02 205 428 (d)
- 10- 77 02 096 235 (c)(d)

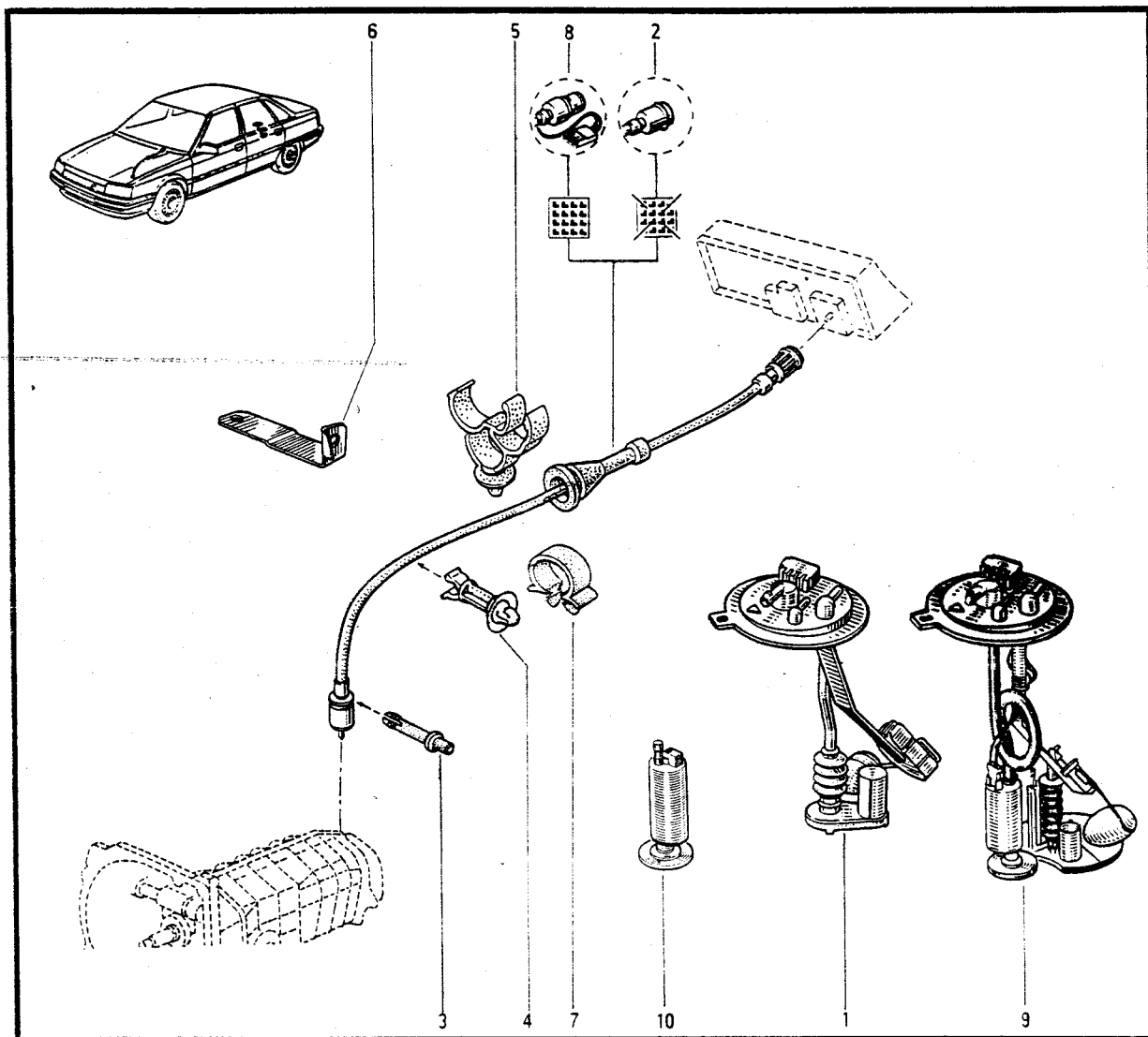

(a) L488 - K488 - K487

(c) L48G - K48G

L48S ↔ n° 11818 ⇨ n°

(b) K48S ↔ n° 01948 ⇨ n°

L48Z - L48Y

K48Y

(d) L48K - K48X 210
L48X 208



84.01
P.R. 1233

- 1- 77 00 764 720
- 2- 77 00 765 710
- 3- 77 00 764 729 +
- 77 00 810 967
- 4- 77 00 766 407
- 5- 77 00 766 268
- 6- 77 03 008 038
- 7- 77 00 765 711

84.01
P.R. 1233

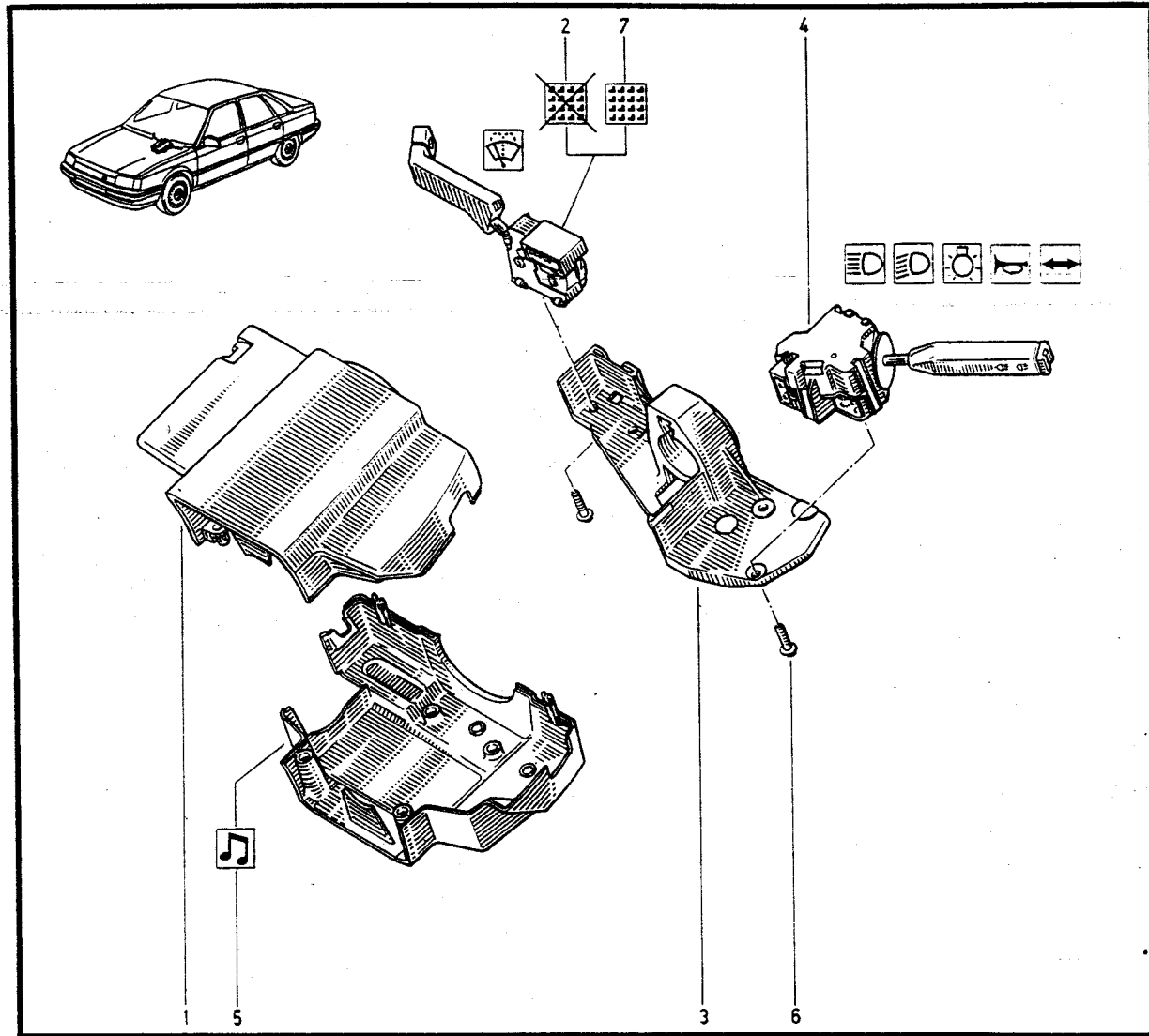

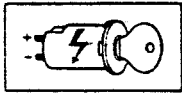

84.10

P.R. 1233

- 1-77 00 766 093
- 2-77 00 807 307
- 3-77 03 004 149
- 4-77 01 029 904

84.10

P.R. 1233

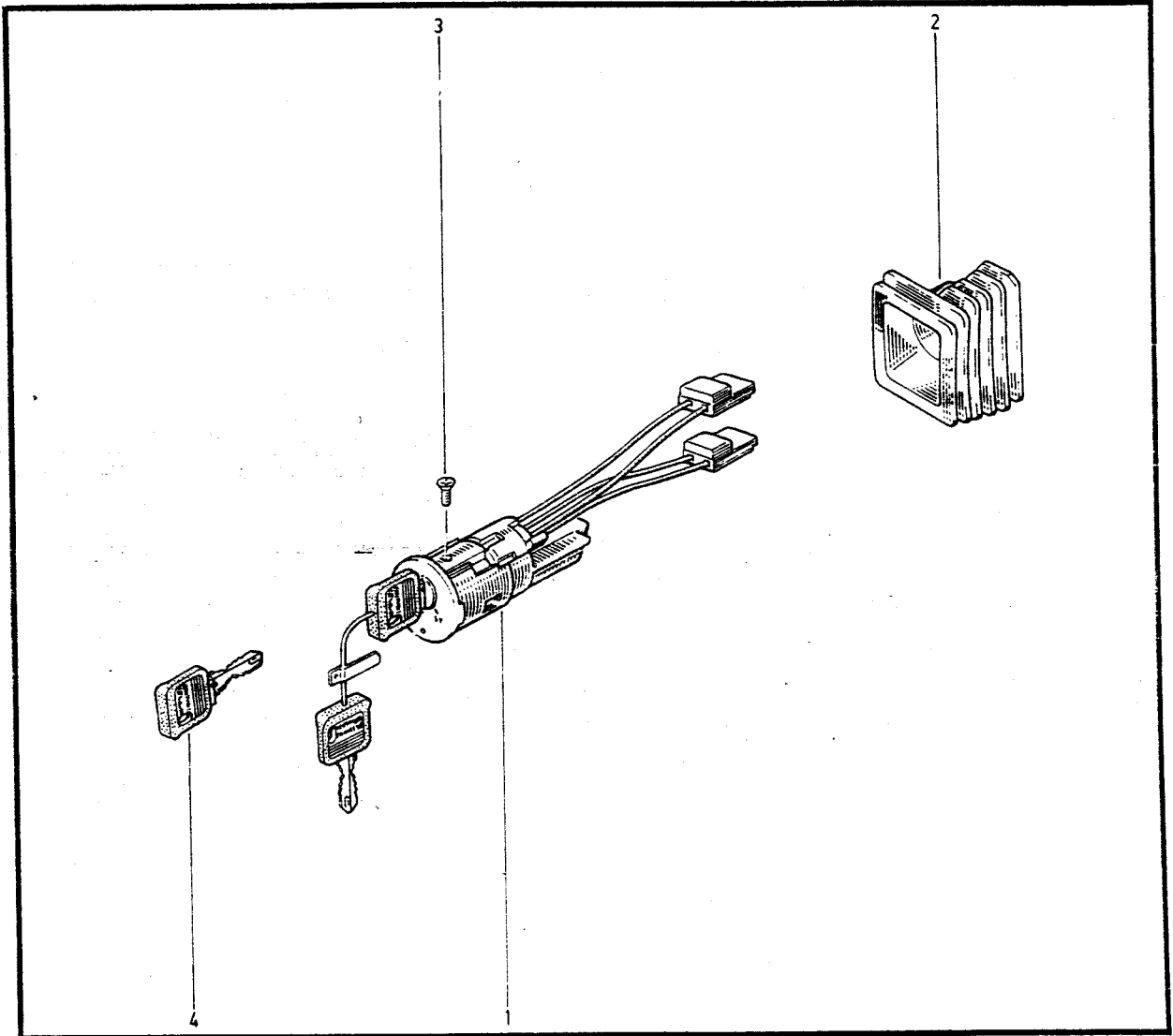

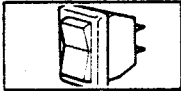

84 20

P.R. 1233

84 20

P.R. 1233

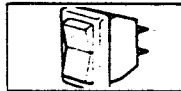

1- 77 00 766 367
2- 77 00 787 784
3- 77 00 793 188
4- 77 00 807 538
5- 77 00 794 686
6- 77 00 797 519
7- 77 00 794 559
8- 77 00 794 672
9- 77 00 807 537
10- 77 00 794 674
11- 77 00 794 670
12- 77 00 794 673
13- 77 00 794 671
14- 77 00 817 816
15- 77 00 794 675
16- 77 00 788 337

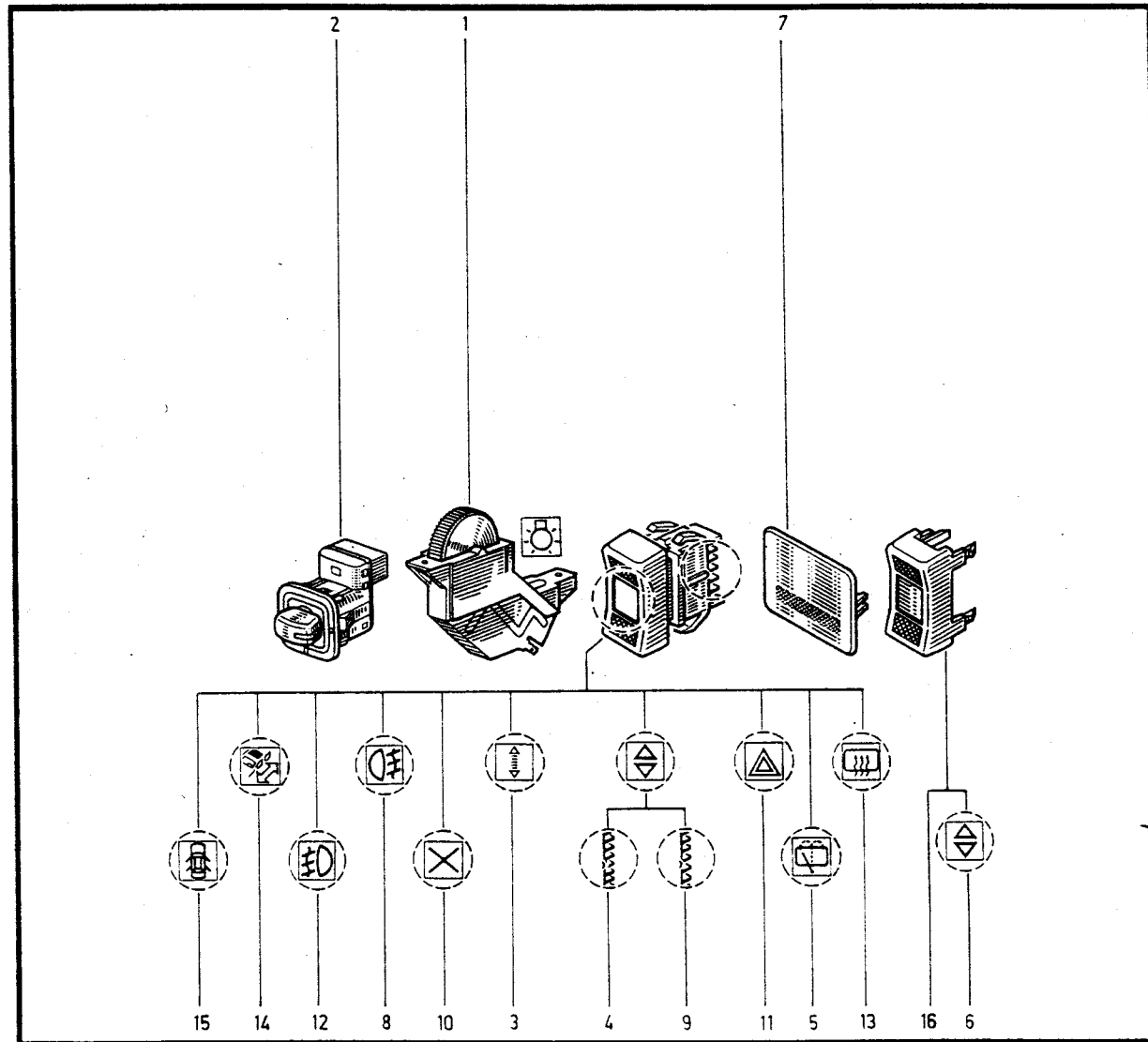

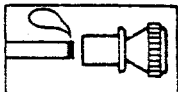

84.30
P.R. 1233

- 1- 77 02 205 410
- 2- 77 00 787 915
- 3- 77 00 900 429 (a)

84.30
P.R. 1233

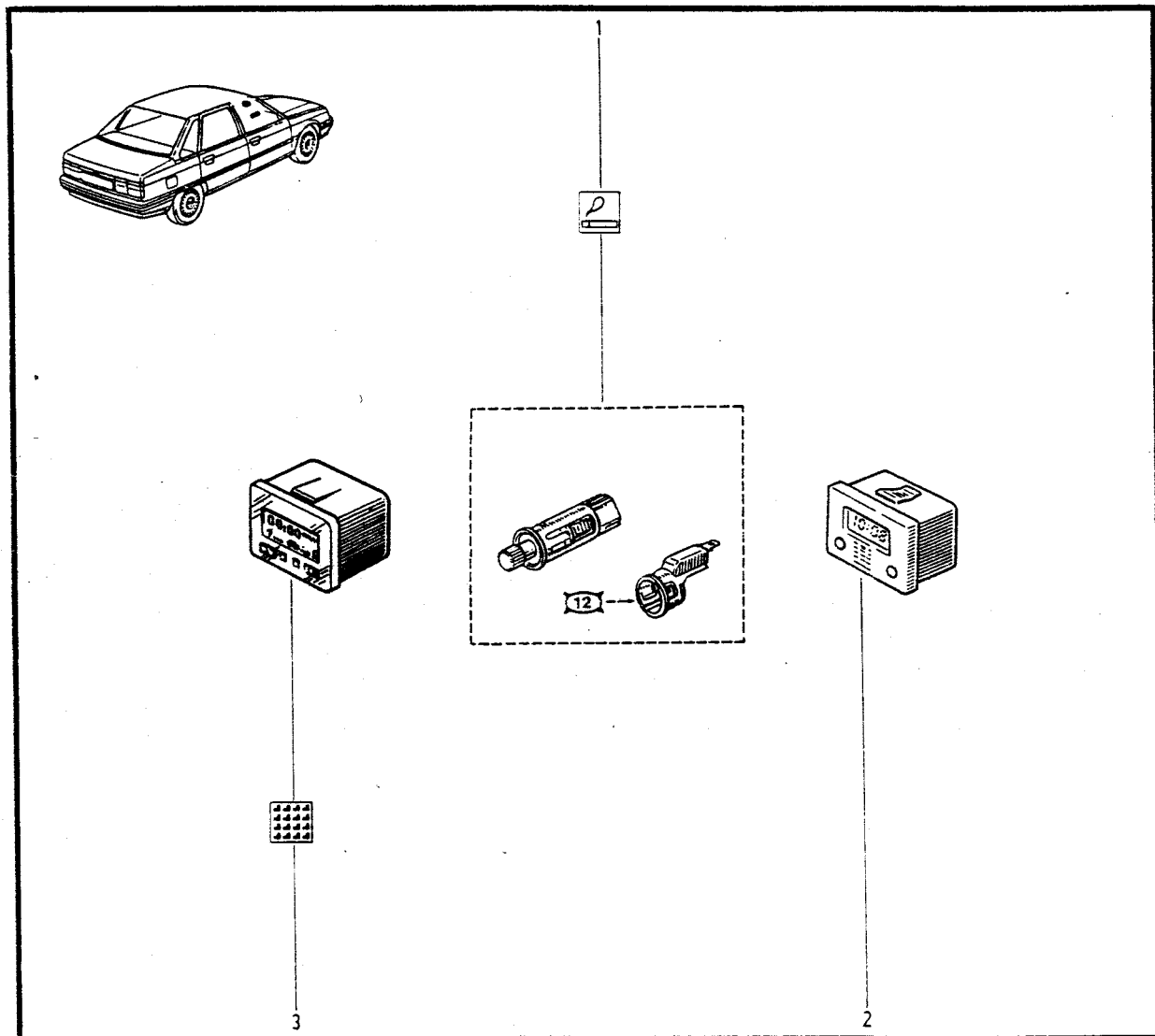
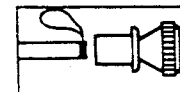

(a)	L48S		n°	1	⇒	n°	11819
	K48S		n°	1	⇒	n°	01948



85.03

P.R. 1233

85.03

P.R. 1233



- 1 - 77 02 206 173
- 2 - 77 02 206 174
- 3 - 77 02 206 175
- 4 - 77 03 044 097
- 5 - 77 02 206 176
- 6 - 77 02 206 177
- 7 - 77 02 206 178
- 8 - 77 03 037 011
- 9 - 77 02 206 179

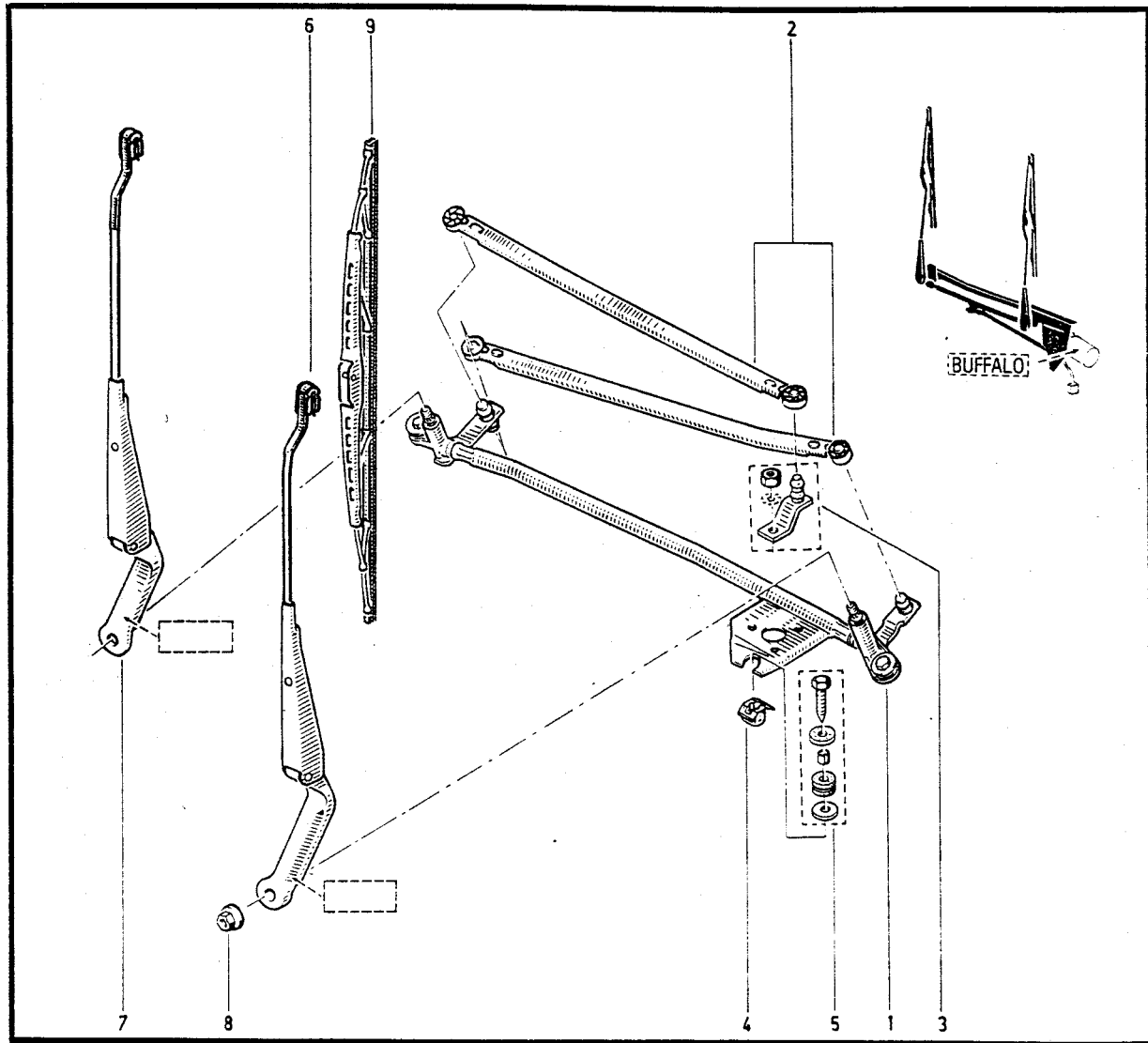



85.18

P.R. 1233



85.18

P.R. 1233



- 1-77 00 766 527
- 2-77 02 217 058 (A)
- 3-77 02 217 059 (A)
- 4-77 00 615 808
- 5-77 00 766 425
- 6-77 03 032 067
- 7-77 02 072 707
- 8-77 03 037 013
- 9-77 01 033 430
- 77 02 217 491 (A)

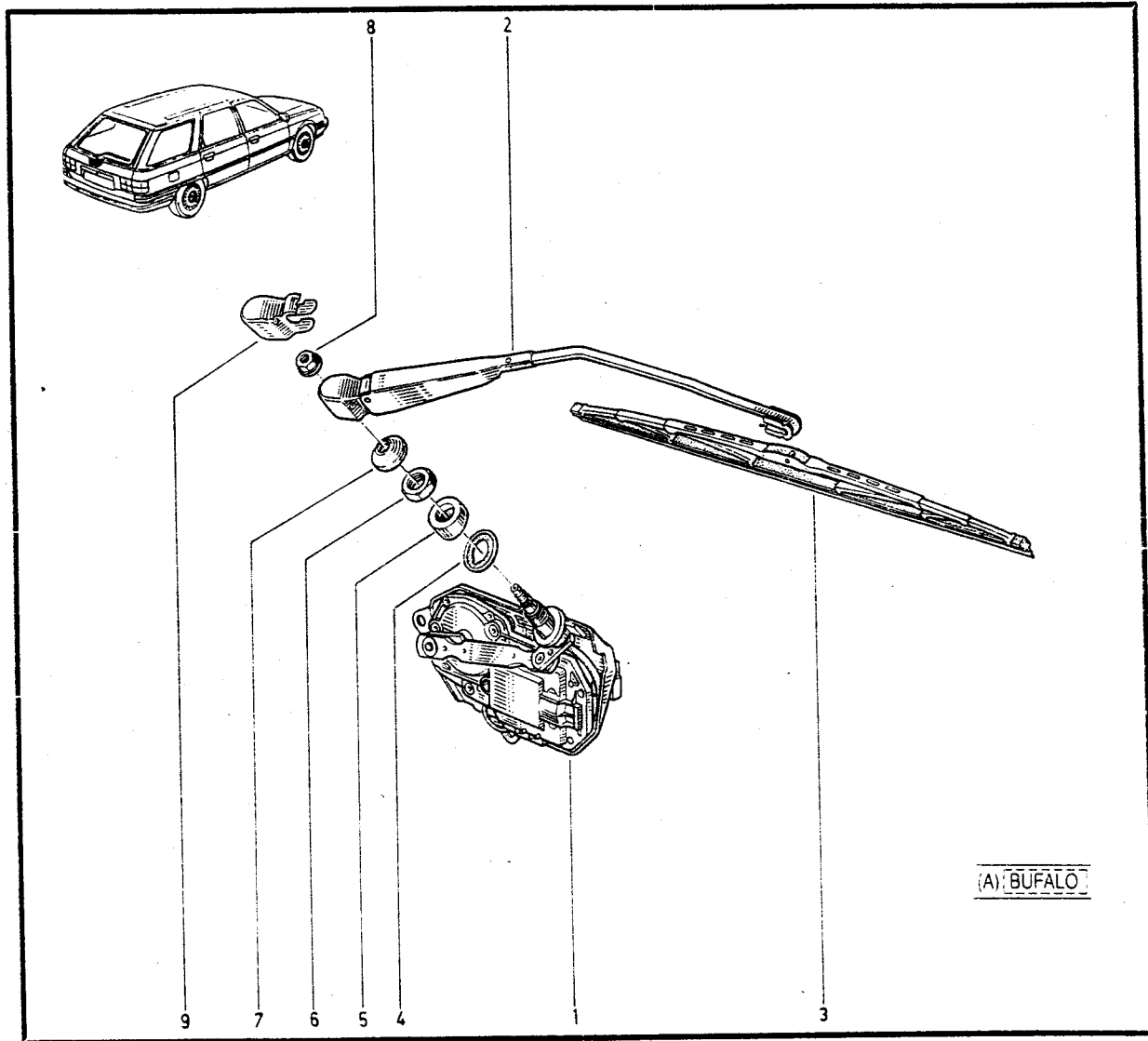



85.23
P.R. 1233



85.23
P.R. 1233



1-77 02 206 180

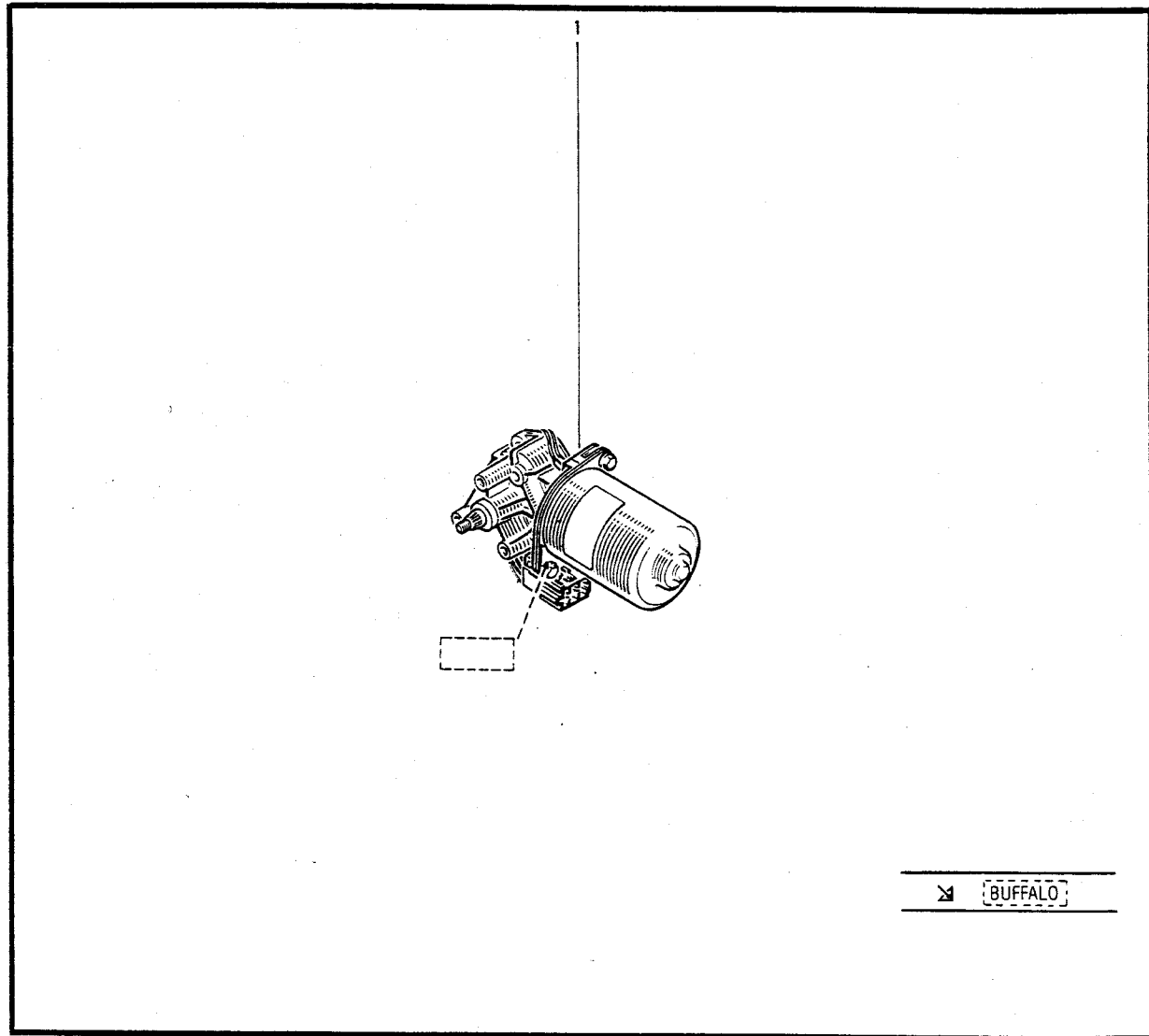

 BUFFALO

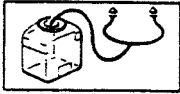

86.01
P.R. 1233



86.01
P.R. 1233



- 1- 77 02 205 380
- 2- 77 04 000 043
- 3- 77 03 074 255
- 4- 77 04 002 215
- 5- 77 05 002 060
- 6- 77 00 772 748
- 7- 77 04 000 008
- 8- 77 03 079 411
- 9- 77 00 650 181 ✂ 1m

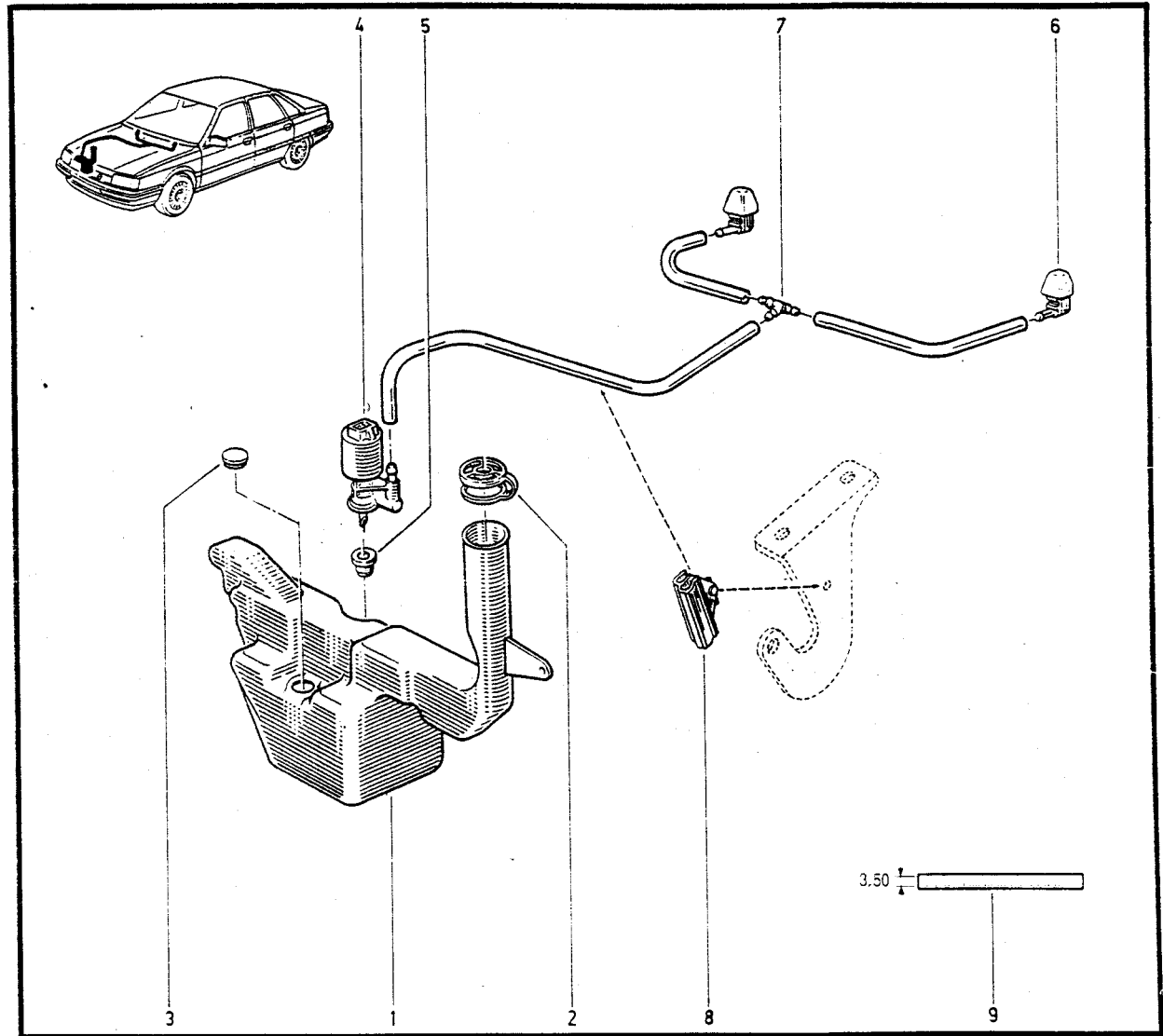



86.15

P.R. 1233



86.15

P.R. 1233



- 1- 77 00 772 937
- 2- 77 04 000 043
- 3- 77 01 034 117
- 4- 77 04 001 019
- 5- 77 00 650 181
- 6- 77 04 000 051

✂ 1m

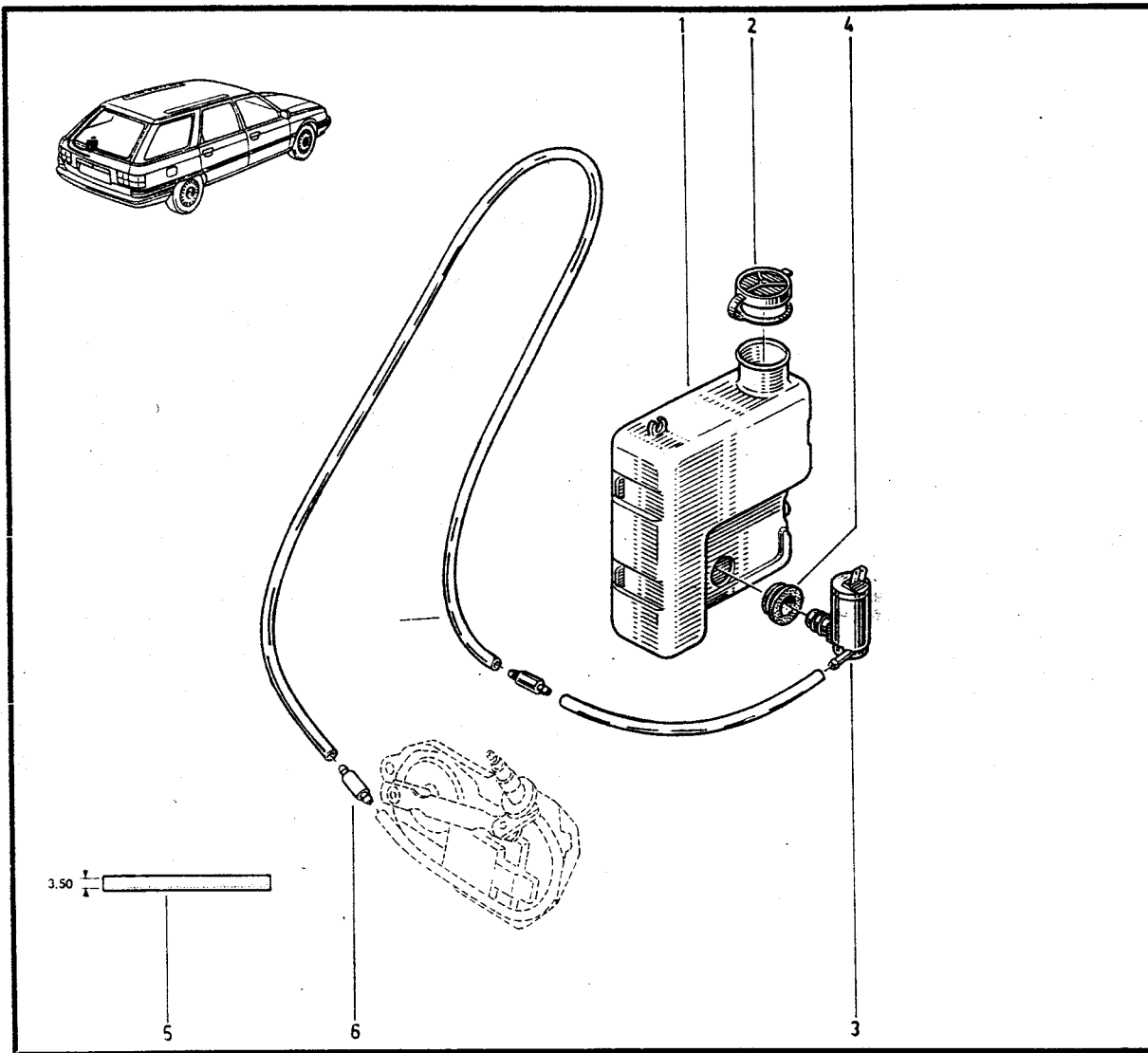

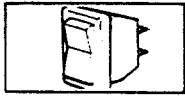

86.20

P.R. 1233

- 1 - 77 00 652 153
- 2 - 77 02 072 708
- 3 - 77 03 080 036
- 4 - 77 00 778 781

86.20

P.R. 1233

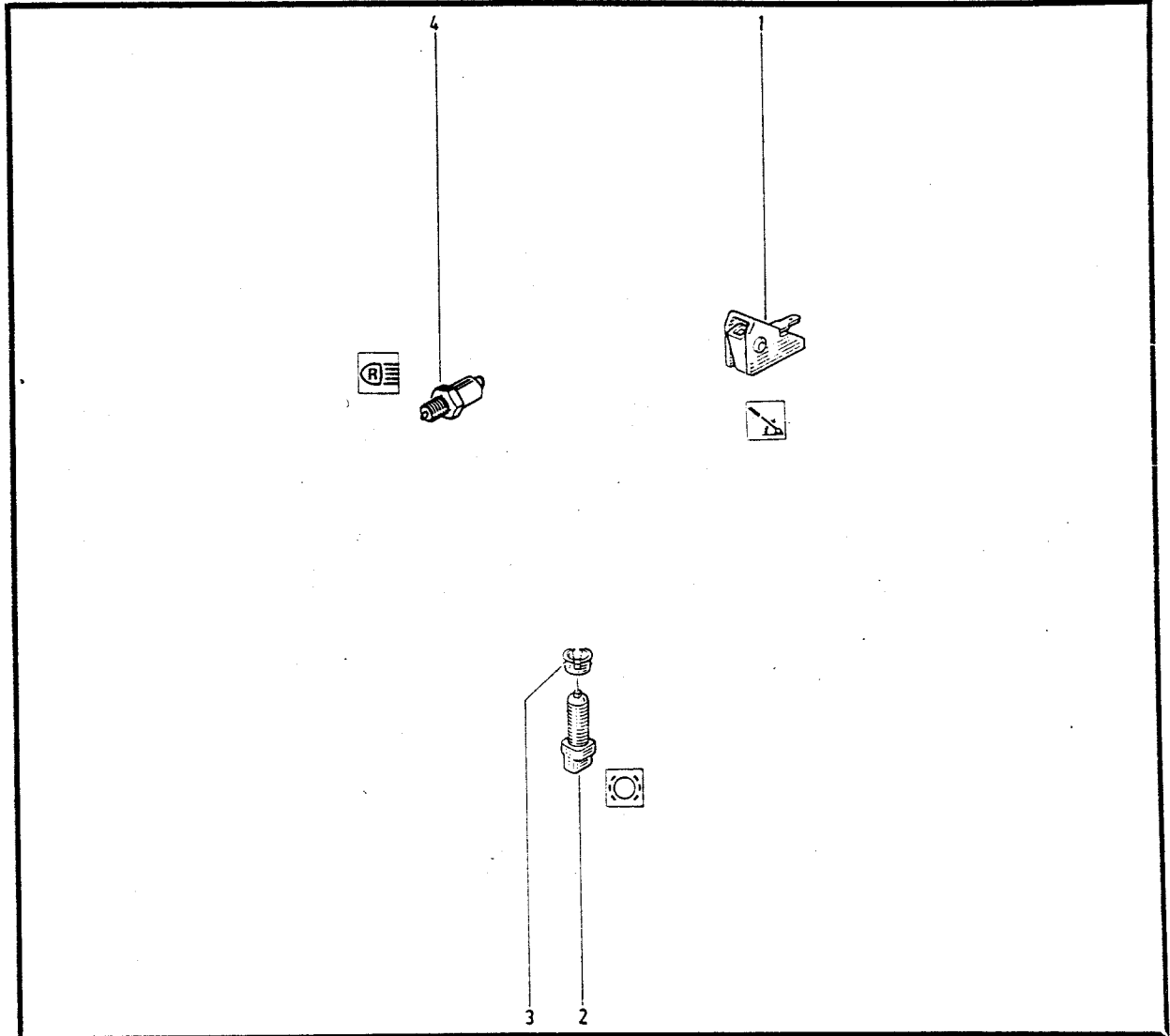
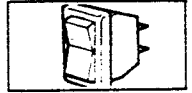



86.30

P.R. 1233

86.30

P.R. 1233



- 1- 77 02 205 412 †
- 77 02 205 457 †
- 2- 77 02 205 453 (C.D.)
- 3- 77 02 205 177
- 77 02 205 456 (C.D.)
- 4- 77 02 205 402 (b)†(20)
- 5- 77 02 205 434 (c)
- 6- 77 02 205 444 (a)

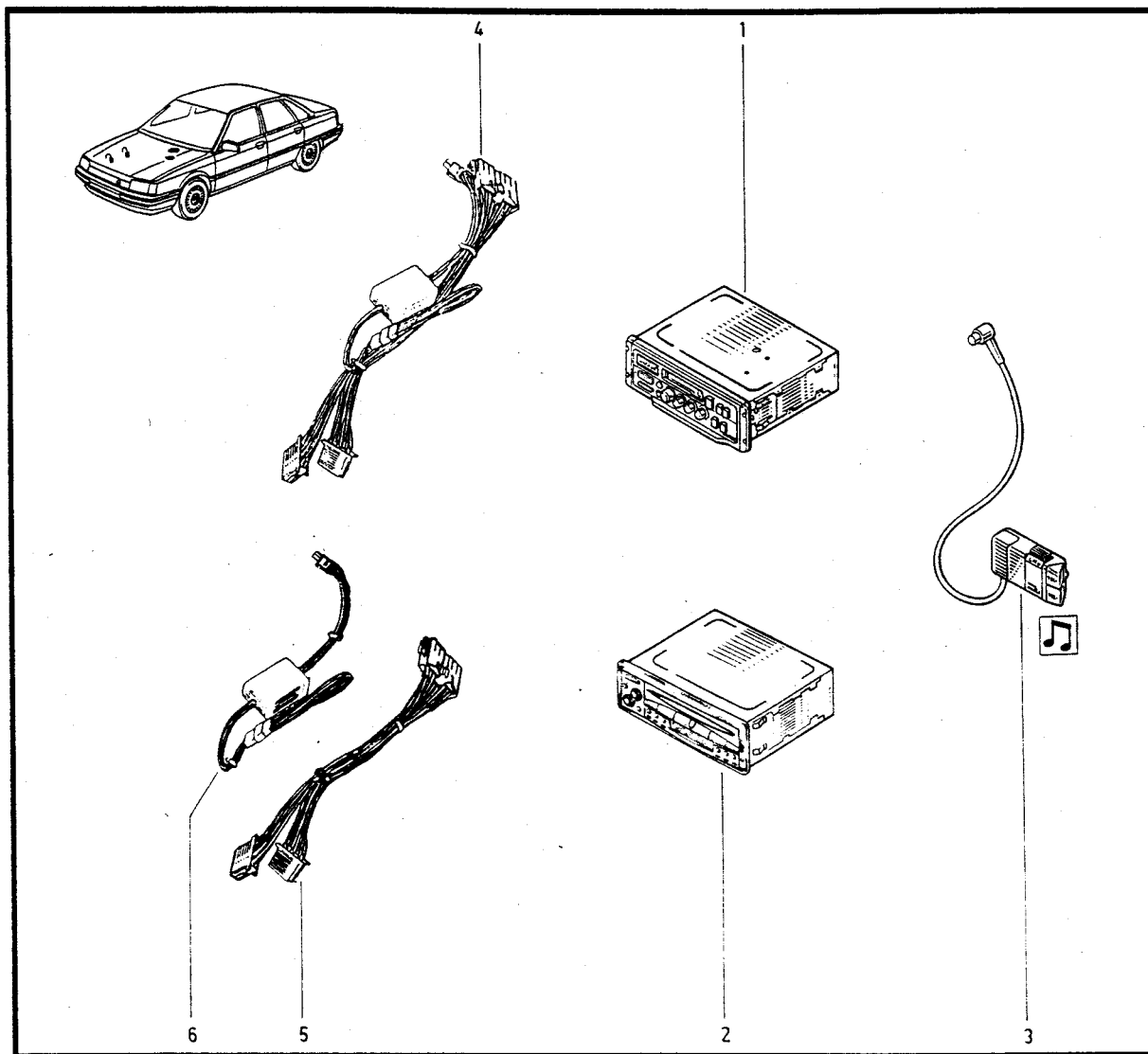

L48Y	↔	n²	1	↔	n²
K48Y	↔	n²	1	↔	n²
K48S	↔	n² 02397	↔	n²	12.93	
L48S	↔	n² 13556	↔	n²	
K488	↔	n² 00110	↔	n²	12.93	
L488	↔	n² 00780	↔	n²	12.93	
L48Z	↔	n² 00495	↔	n²	12.93	
K48G	↔	n²	1	↔	n²
L48G	↔	n²	1	↔	n²
K48X	↔	n²	1	↔	n²
L48X	↔	n²	1	↔	n²
L48K	↔	n²	1	↔	n²
K487	↔	n²	1	↔	n²

(a)

K48S	↔	n² 01835	↔	n² 02396	
L48S	↔	n² 11087	↔	n² 13555	
L488	↔	n² 1	↔	n² 00779	
L48Z	↔	n² 1	↔	n² 00494	
K488	↔	n² 1	↔	n² 00109	

(b)

K48S	↔	n² 02397	↔	n² 12.93	
L48S	↔	n² 13556	↔	n² 12.93	
K488	↔	n² 00110	↔	n² 12.93	
L488	↔	n² 00780	↔	n² 12.93	
L48Z	↔	n² 00495	↔	n² 12.93	

(c)

7702205434
(20)† 7702205444



86.31

P.R. 1233

86.31

P.R. 1233



- 1-77 02 072 956 [S]
- 2-77 02 206 038 [S]
- 3-77 00 646 863 (L=350)
- 4-77 02 072 110
- 5-77 02 072 958 [S]
- 6-77 02 205 403
- 7-77 02 082 673
- 8-77 02 205 290 (L=180)
- 77 02 205 291 (L=650)
- 77 02 205 201 (L=400)

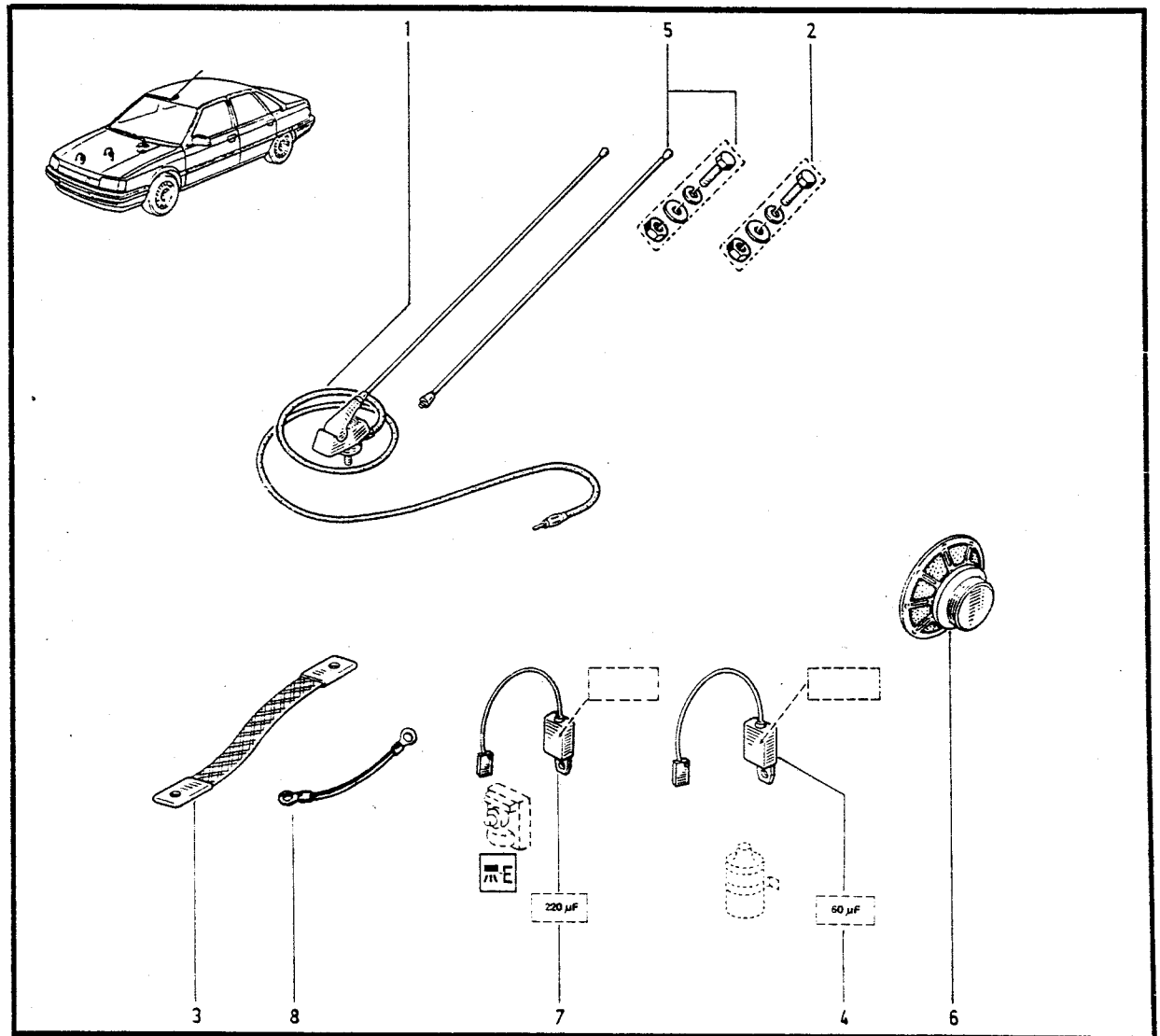

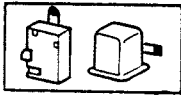

87.30
P.R. 1233

- 1- 77 00 767 692
- 2- 77 00 766 446
- 3- 77 00 766 447
- 4- 77 00 767 479
- 5- 77 03 079 366
- 6- 77 02 205 152
- 7- 77 01 997 040
- 8- 77 01 996 073 [5]
- 77 01 996 074 [18]
- 77 01 996 075 [21]

87.30
P.R. 1233

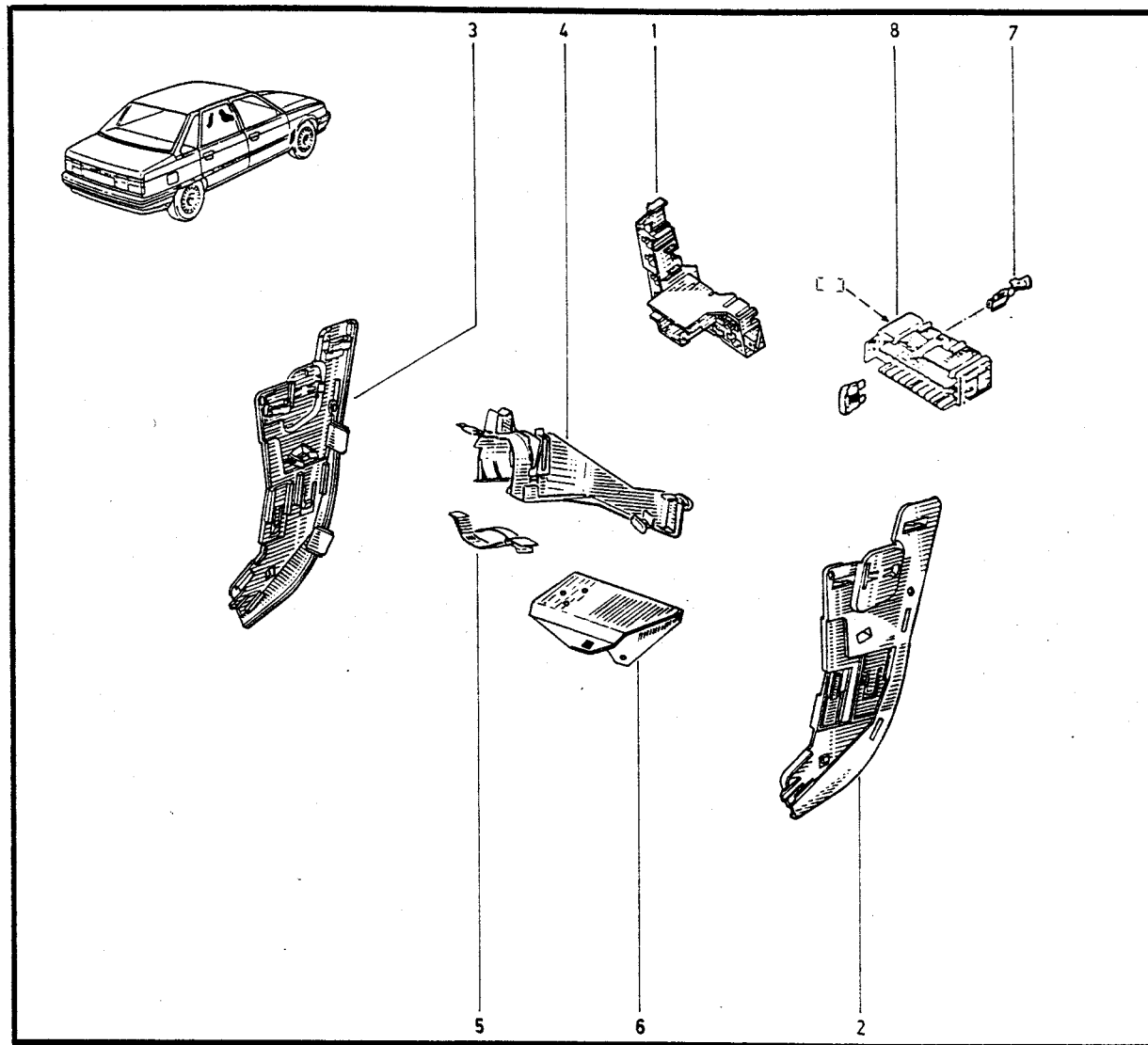
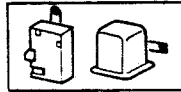



87.40

P.R. 1233

87.40

P.R. 1233



- 1-77 02 205 327
- 2-77 02 072 906
- 3-77 00 772 350
- 77 02 205 302
- 4-77 02 205 122
- 5-77 00 756 997
- 6-77 00 728 087
- 7-77 02 205 326
- 8-77 02 205 157
- 9-77 00 768 332
- 10-77 00 780 515
- 11-77 00 768 953
- 12-77 02 205 214
- 13-77 02 072 090
- 14-77 02 218 567
- 15-77 00 810 926 [5](25AMP)
- 16-77 02 218 566

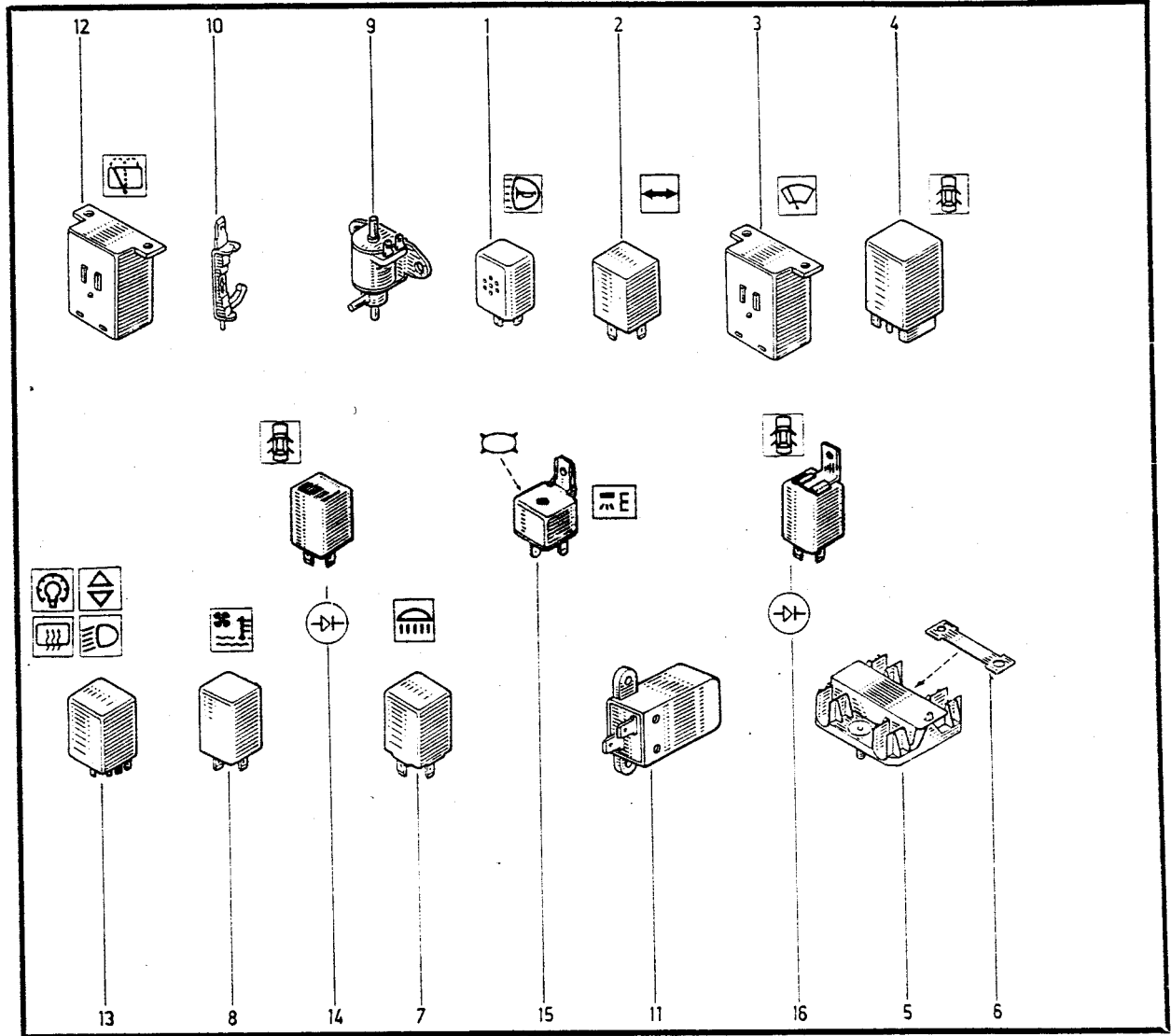

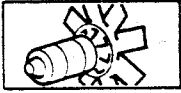

87.52

P.R. 1233

- 1- 77 01 029 940
- 2- 77 00 773 856
- 3- 77 01 029 941
- 4- 77 00 773 855
- 5- 77 03 016 401
- 6- 77 03 004 131
- 7- 77 00 798 264
- 8- 00 10 545 600
- 9- 77 01 031 959
- 10- 77 02 198 205
- 11- 77 02 198 187

87.52

P.R. 1233

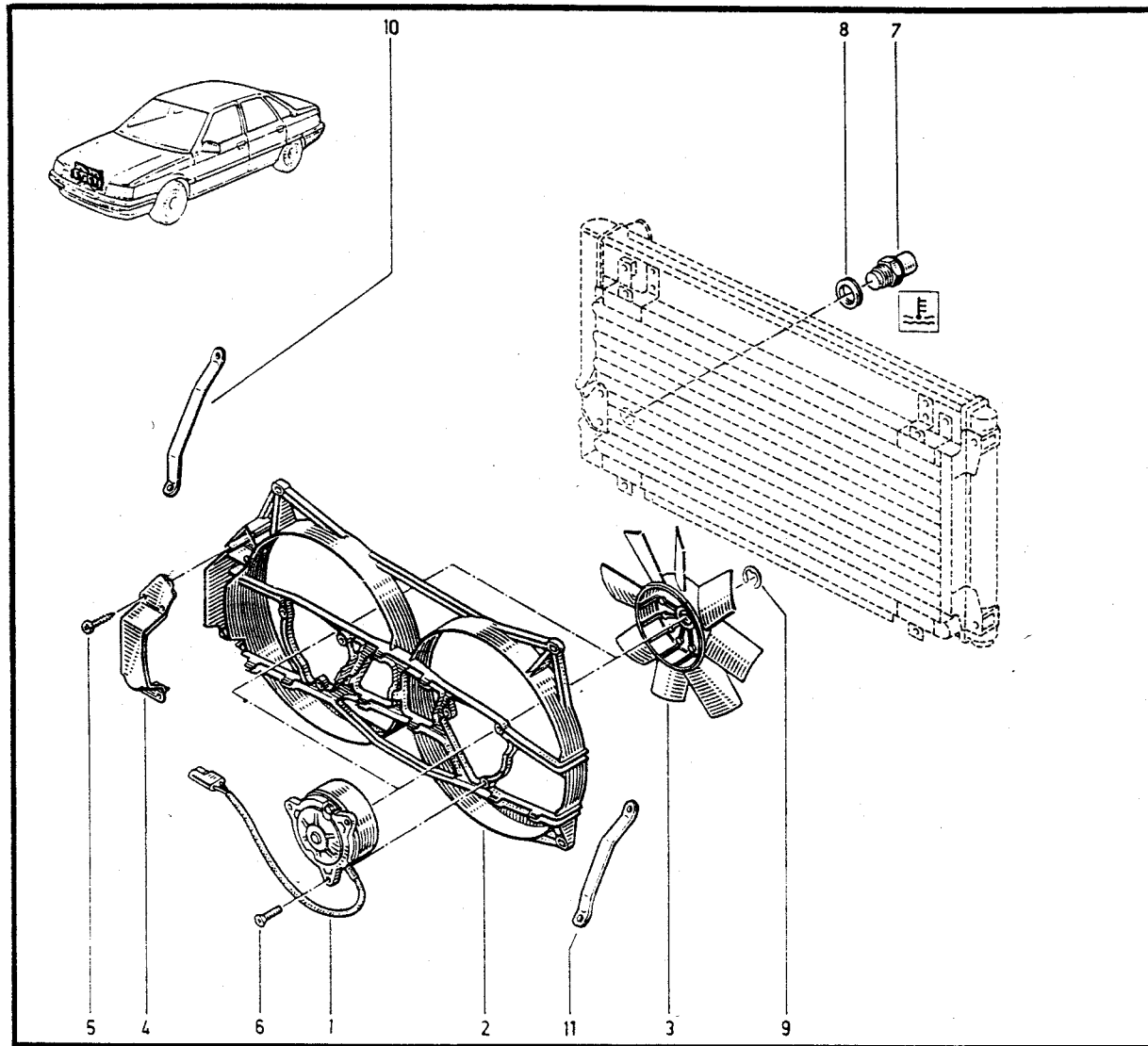
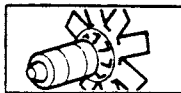



88.01

P.R. 1233

88.01

P.R. 1233



- 1- 77 02 205 395 (a)+(20)
- 77 02 205 417 (b) (c)
- 77 02 205 409 (d)
- 2- 77 02 205 227
- 3- 77 02 216 589 (a)(b)(c)
- 77 02 216 591 (d)
- 4- 77 01 987 766
- 5- 77 02 205 295
- 77 02 205 424 (ABS)

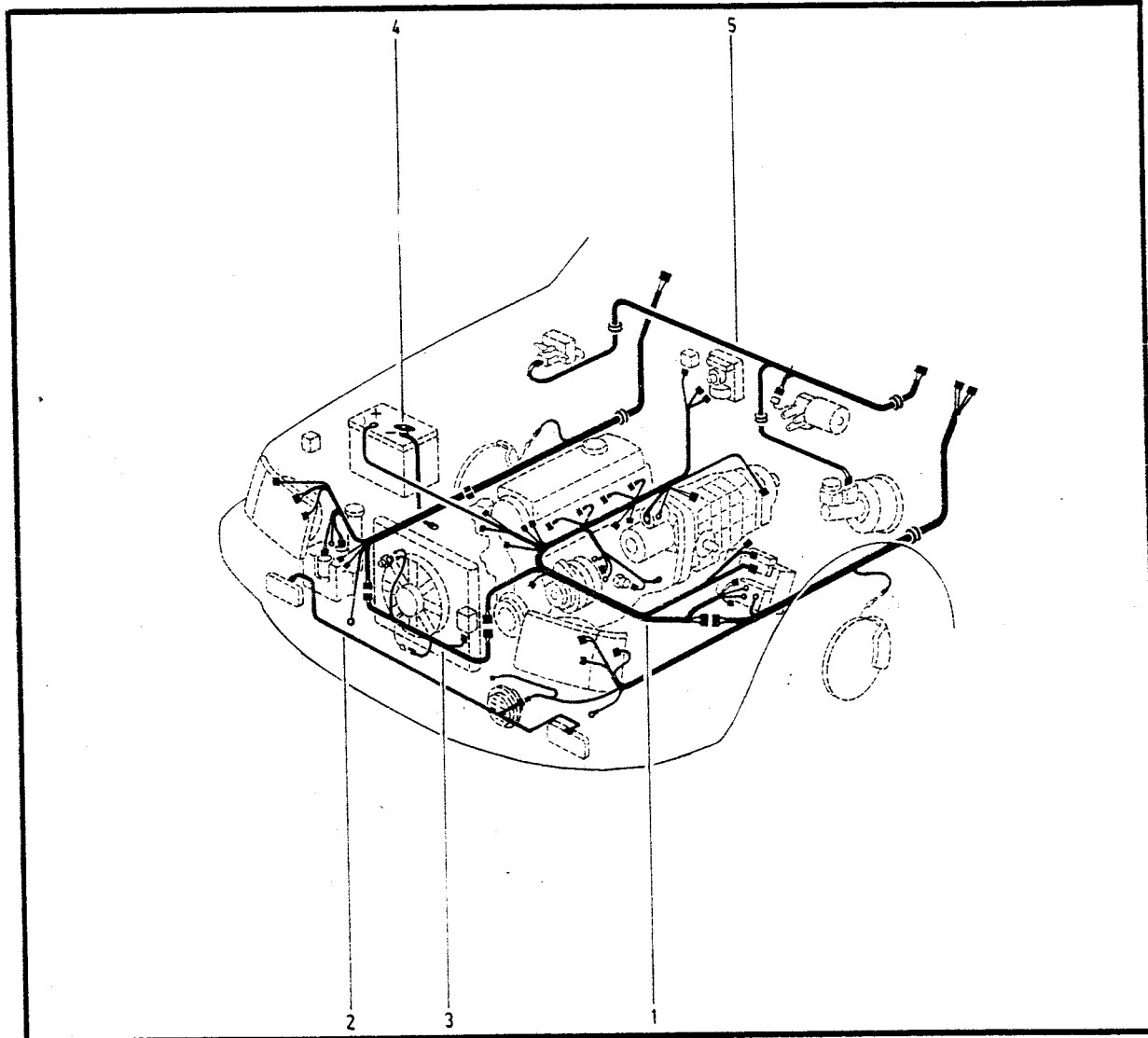

(a)	L488 089	⇄	n ²	1	⇄	n ² 09.93
	K488 089	⇄	n ²	1	⇄	n ² 09.93
	L48S 091	⇄	n ² 9824		⇄	n ² 09.93
	K48S 090/092	⇄	n ² 1319		⇄	n ² 09.93

(b)	L488	⇄	n ²	09.93	⇄	n ² 12.93
	K488	⇄	n ²	09.93	⇄	n ² 12.93
	L48S	⇄	n ²	09.93	⇄	n ²
	K48S	⇄	n ²	09.93	⇄	n ² 12.93
(c)	K487	⇄	n ²	1	⇄	n ²

(d)	L48Y	⇄	n ²	1	⇄	n ²
	L48Z	⇄	n ²	1	⇄	n ²
	K48Y	⇄	n ²	1	⇄	n ²

(20) ⇄ 7702205417-1
 7700771821-1
 7700771825-1

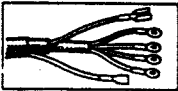

88.01.5

P.R. 1233

88.01.5

P.R. 1233

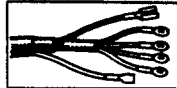

- 1- 77 02 205 395 (a) † (20)
- 77 02 205 408 (b) (E 示)
- 2- 77 02 205 227
- 3- 77 02 216 589 (a)
- 77 02 216 591 (b) (E 示)
- 4- 77 01 987 766
- 5- 77 02 205 295
- 77 02 205 424 (c) (ABS)

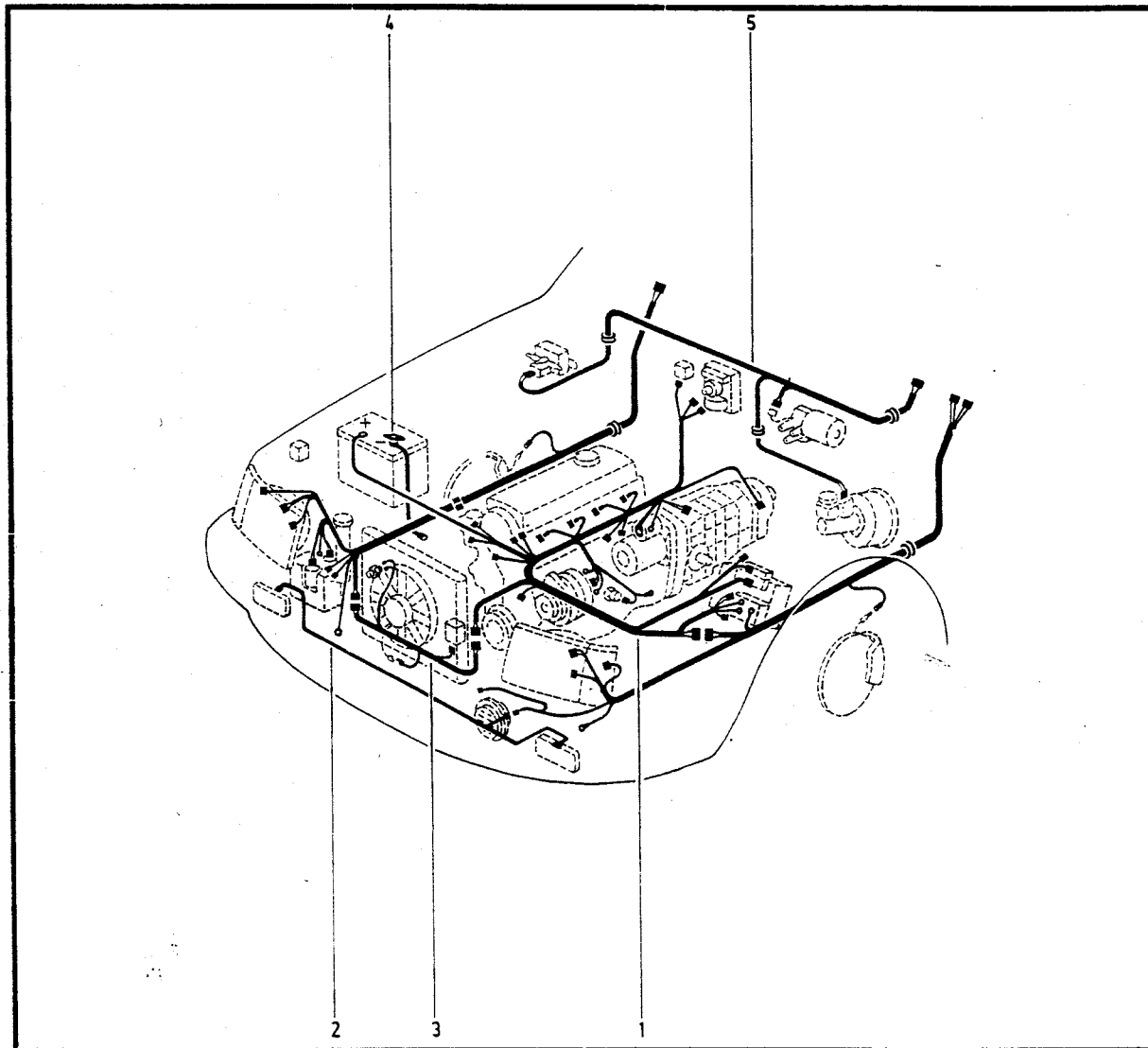

	L488 202
(a)	L48S 208
	K48S 210
	K488 202

	L48K 208/209
(b)	L48G
	L48X
	K48G
	K48X

(c) L48K 209

(20) † 7702205417-1
 7700771821-1
 7700771825-1

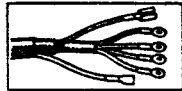

88.04

P.R. 1233

88.04

P.R. 1233



- 1- 77 02 205 396 (a)
- 77 02 205 407 (b)
- 77 02 221 700 (c)
- 77 02 221 701 (d)
- 77 02 205 397 (e)
- 2- 77 02 205 405
- 77 02 205 406 (e)
- 3- 77 02 205 216 (f)
- 77 02 205 337 (g)
- 77 02 205 440 (h)
- 77 02 205 441 (i)

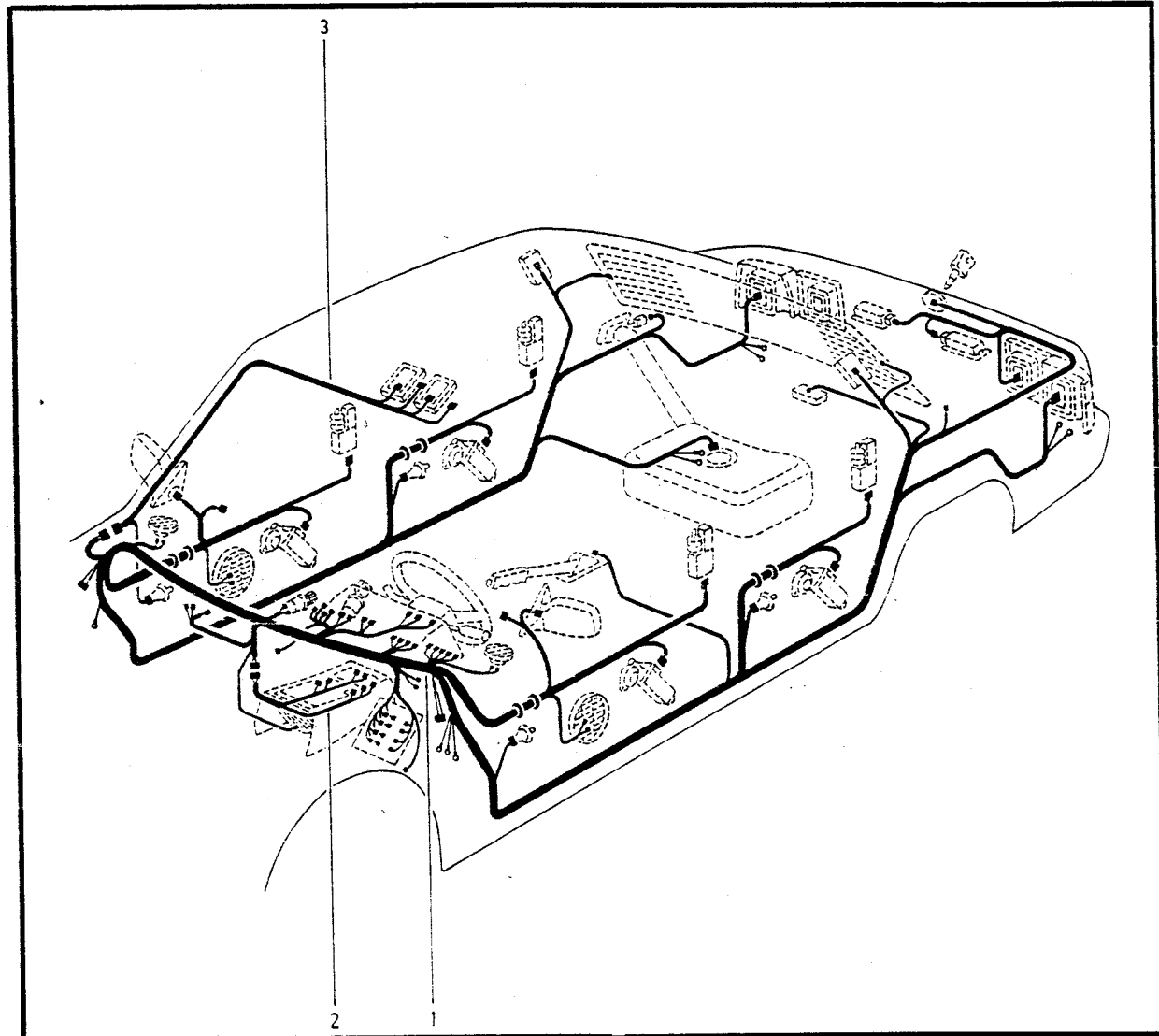

(a) /	L48S 091	↔	n° 09824	↔	n° 12.93
(b) /	L48Z 091	↔	n° 1	↔	n° 12.93
(c) /	L48S 090	↔	n° 12.93	↔	n°
(d) /	L48Z	↔	n° 12.93	↔	n°
	L48Y	↔	n° 1	↔	n°

(e) /	L488 089	↔	n° 1	↔	n° 12.93
(f) /	L48S 091	↔	n° 9824	↔	n° 15226
	L48Z 091	↔	n° 1	↔	n° 00991
(g) /	L488 089	↔	n° 1	↔	n° 01560

(h) /	L48S 090/091	↔	n° 15227	↔	n°
	L48Z	↔	n° 00992	↔	n°
	L48Y	↔	n° 1	↔	n°
(i) /	L488 089	↔	n° 01561	↔	n°

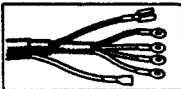

88.04.5

P.R. 1233

88.04.5

P.R. 1233



- 1- 77 02 205 397 (a)
- 77 02 205 396 (b)
- 77 02 205 407 (c)
- 77 02 205 430 (e)
- 77 02 205 437 (d)
- 77 02 221 701 (g)
- 2- 77 02 205 405
- 77 02 205 406 (a) (d)
- 3- 77 02 205 390 (a)
- 77 02 205 216 (b)
- 77 02 205 442 (f)
- 77 02 205 440 (c) (e) (g)
- 77 02 205 441 (h)

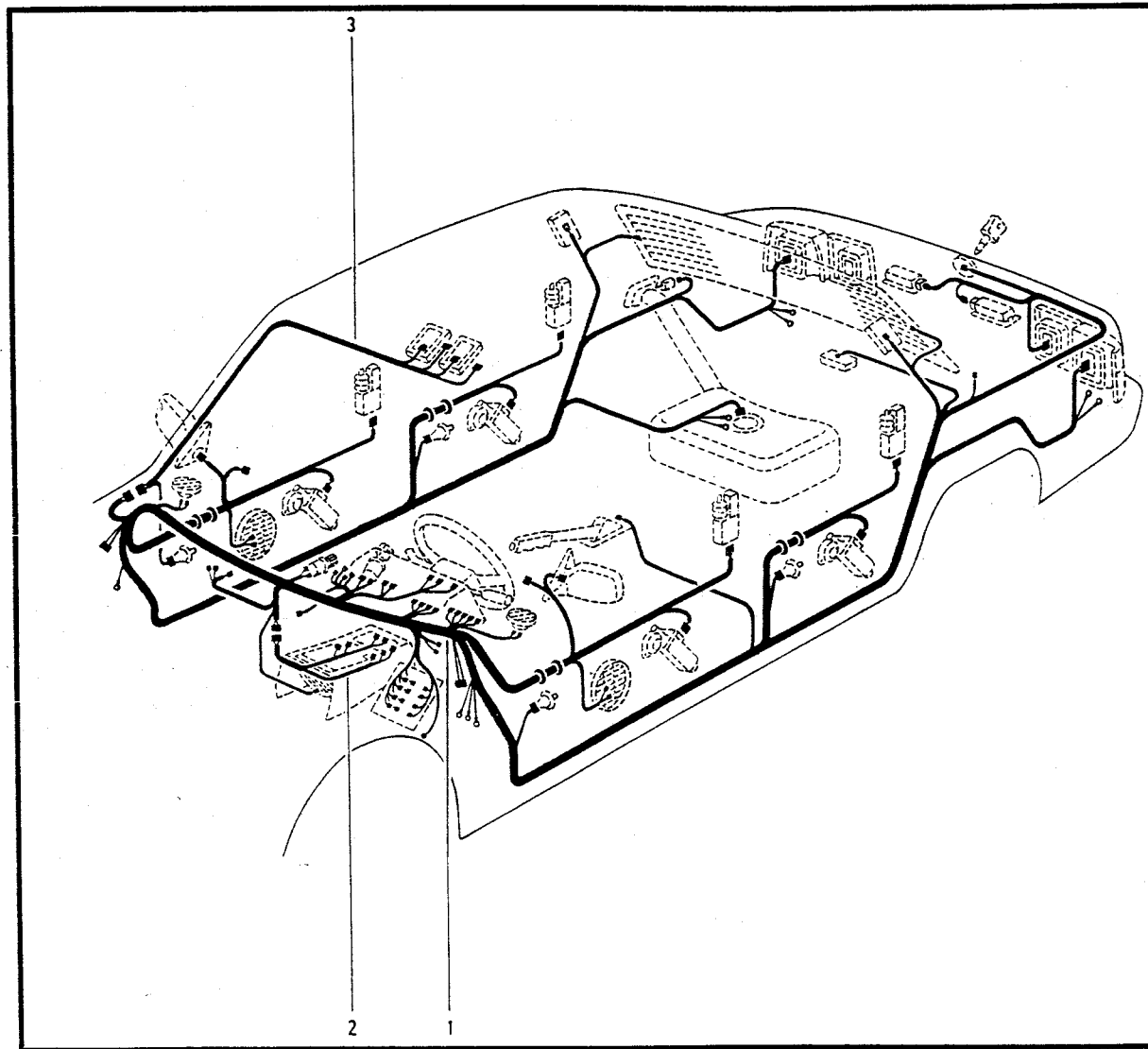

(a) /	L488 202	$\overleftrightarrow{n^2}$	1	$\rightarrow n^2$
(b) /	L48S 208	$\overleftrightarrow{n^2}$	9824	$\rightarrow n^2$
(c) /	L48K 208	$\overleftrightarrow{n^2}$	1	$\rightarrow n^2$
(d) /	L48G	$\overleftrightarrow{n^2}$	1	$\rightarrow n^2$
(e) /	L48K 209	$\overleftrightarrow{n^2}$	1	$\rightarrow n^2$ 12.93
	L48X	$\overleftrightarrow{n^2}$	1	$\rightarrow n^2$ 12.93

(f) /	L48G	$\overleftrightarrow{n^2}$	1	$\rightarrow n^2$ 12.93
(g) /	L48K 209	$\overleftrightarrow{n^2}$	12.93	$\rightarrow n^2$
	L48X	$\overleftrightarrow{n^2}$	12.93	$\rightarrow n^2$
(h) /	L48G	$\overleftrightarrow{n^2}$	12.93	$\rightarrow n^2$

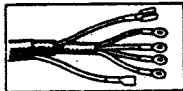

88.06

P.R. 1233

88.06

P.R. 1233

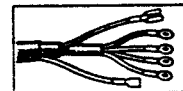

- 1- 77 02 205 400 (a)
- 77 02 205 399 (b)
- 77 02 205 436 (c)
- 77 02 221 703 (d)
- 2- 77 02 205 405 (c) (e)
- 77 02 205 406 (a) (d)
- 3- 77 02 205 337 (h)
- 77 02 205 216 (f)
- 77 02 205 440 (c) (g)
- 77 02 205 441 (d) (i)
- 4- 77 02 205 346
- 5- 77 02 205 387 (c) (e)
- 77 02 205 347 (a) (d)
- 6- 77 02 205 200

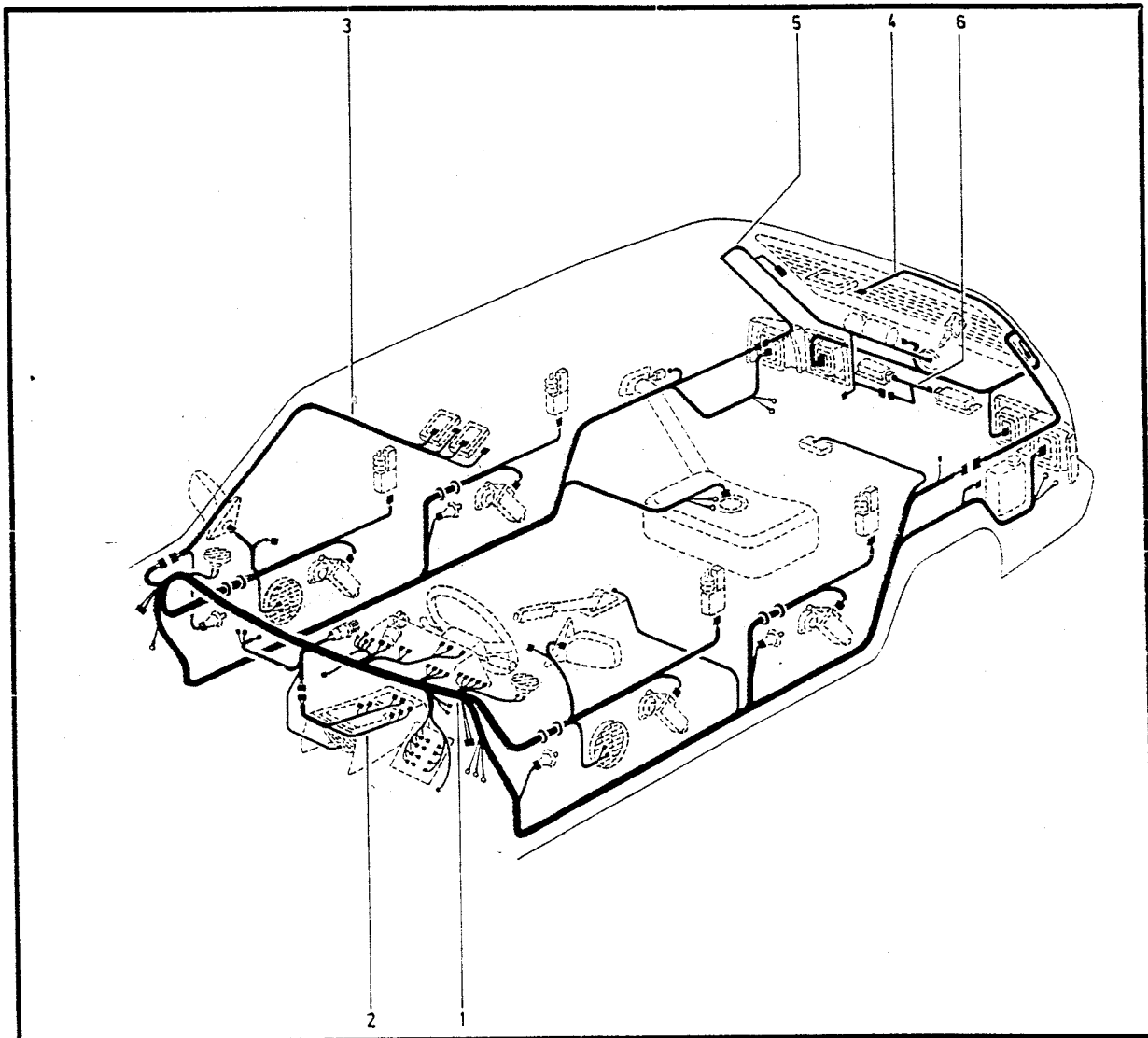

- (a) K488 089
- (b) K48S 090/092
- (c) K48Y
- (d) K487
- (e) K48S 090/092 ⇔ n° 01319 ⇨ n°

- (f) K48S 090/092 ⇔ n° 1 ⇨ n° 02926
- (g) K48S 090/092 ⇔ n° 02927 ⇨ n°
- (h) K488 089 ⇔ n° 1 ⇨ n° 00280
- (i) K488 089 ⇔ n° 00281 ⇨ n°

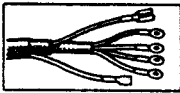

88.06.5

P.R. 1233

88.06.5

P.R. 1233

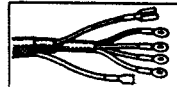

- 1- 77 02 205 400 (a)
- 77 02 205 399 (b)
- 77 02 205 436 (c)
- 77 02 205 438 (d)
- 2- 77 02 205 405 (b)(c)
- 77 02 205 406 (a)(d)
- 3- 77 02 205 216 (b)
- 77 02 205 390 (a)
- 77 02 205 440 (c)
- 77 02 205 442 (d)
- 4- 77 02 205 346
- 5- 77 02 205 387 (b)(c)
- 77 02 205 347 (a)(d)
- 6- 77 02 205 200

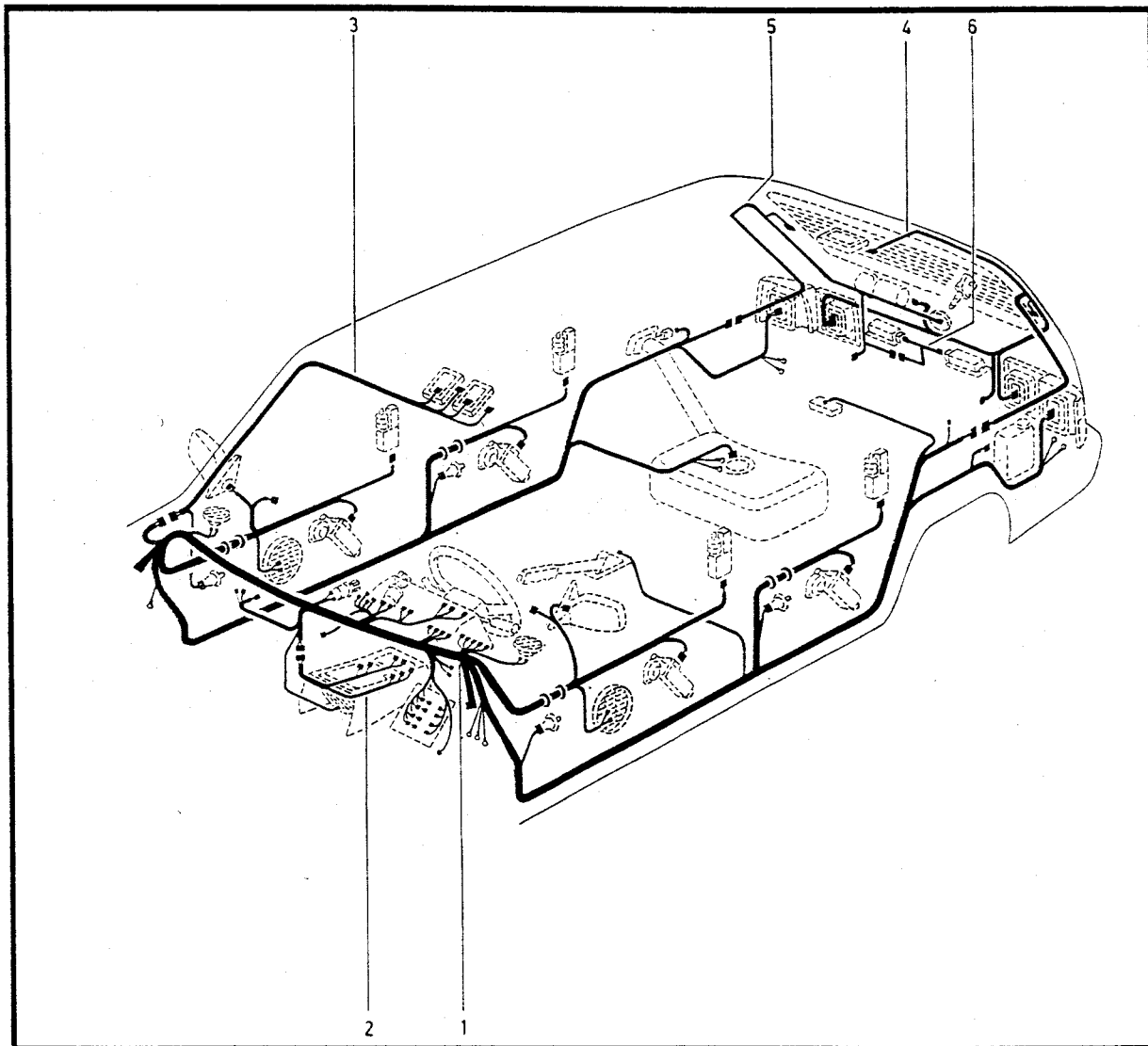

- (a) K488 202
- (b) K48S 210
- (c) K48X
- (d) K48G

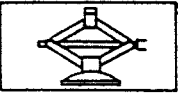

90.01

P.R. 1233

- 1- 77 02 095 085
- 2- 77 00 675 669
- 3- 77 00 805 898
- 4- 77 03 079 455
- 5- 77 02 094 942

90.01

P.R. 1233

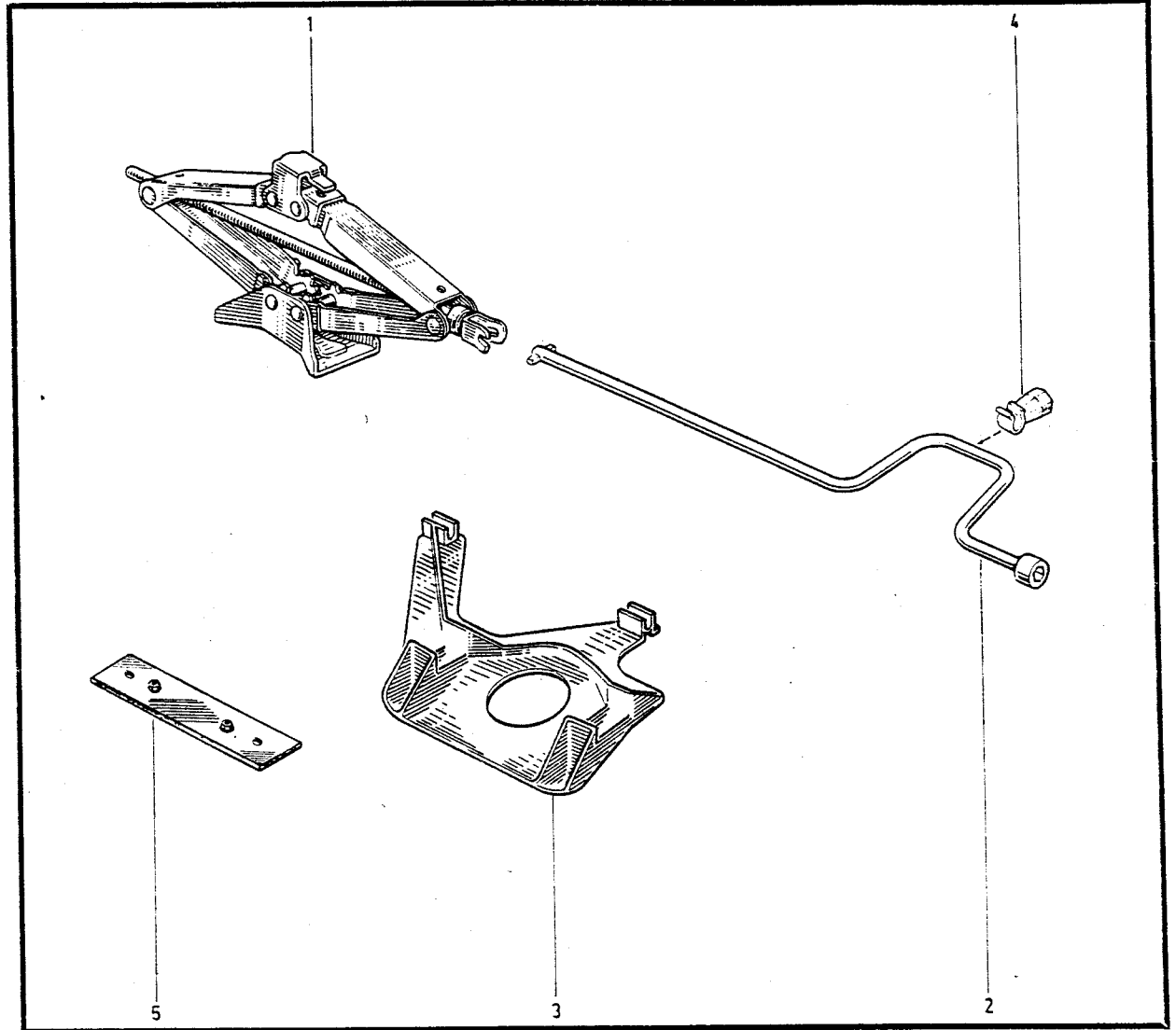
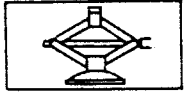



100.00

PR1233

100.00

PR1233



GAMA 1992

COLOR	PIEZA NUMERO	COD. PROV.	CODIGO PINTURA	TAPIZADOS	
				CODIGO	COLOR
BLANCO CHAPELCO	02 24 956 900	A	326	742	TELA HARLEM CENIZA.
	02 25 168 800	G			
				963	CUERO BECERRO NEGRO.
NEGRO ECLIPSE METALIZAD.	02 25 169 400	A	368	742	TELA HARLEM CENIZA.
	02 25 155 600	G			
GRIS TRITON METALIZADO	02 25 095 200	A	412	742	TELA HARLEM CENIZA.
	02 25 169 300	G			
				963	CUERO BECERRO NEGRO.
AZUL MEDIANOCHE	02 25 155 500	G	413	742	TELA HARLEM CENIZA.
				963	CUERO BECERRO NEGRO.
ROJO BIZANTINO	02 25 155 400	G	414	743	TELA HARLEM BEIGE.
				964	CUERO BECERRO BEIGE.
ROJO ASIATICO	02 25 160 300	G	417	743	TELA HARLEM BEIGE.
				742	TELA HARLEM CENIZA.

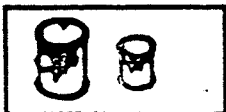

100.01

PR1233

GAMA1993

100.01

PR1233



COLOR	PIEZA NUMERO	CODIGO DE PINTURA	TAPIZADO	
			CODIGO	COLOR
NEGRO ECLIPSE MET.	0225156600	368	742	TELA HARLEM CENIZA
			766	CUERO BECERRO NEGRO
GRIS TRITON MET.	0225169300	412	742	TELA HARLEM CENIZA
			766	CUERO BECERRO NEGRO
ROJO ASIATICO	0225160300	417	742	TELA HARLEM CENIZA
			766	CUERO BECERRO NEGRO
GRIS ALBATROS MET.	0225160000	418	742	TELA HARLEM CENIZA
			766	CUERO BECERRO NEGRO
AZUL ATLANTIS MET.	0225160400	419	742	TELA HARLEM BEIGE
			766	CUERO BECERRO NEGRO
AZUL NANTES MET.	0225179900	423	742	TELA HARLEM CENIZA
			766	CUERO BECERRO NEGRO



100.02

PR1233

GAMA 1994

100.02

PR1233



COLOR	PIEZA NUMERO		CODIGO DE PINTURA	TAPIZADO		
				CODIGO	COLOR	
BLANCO NORDICO	0225184100	G	MONOCAPA	427	762	CUERO BECERRO NEGRO
	0225197800	A				
	0225198300	G	BICAPA	438	723	TELA RAVEL P. CENIZA
	0225198200	A				
NEGRO EMBAJADOR	0225196500	G	BICAPA	433	762	CUERO BECERRO NEGRO
					723	TELA RAVEL P. CENIZA
GRIS ICEBERG	0225197000	G	METALIZADO	434	762	CUERO BECERRO NEGRO
					723	TELA RAVEL P. CENIZA
ROJO PERSA	0225197200	G	PERLADO	436	762	CUERO BECERRO NEGRO
					723	TELA RAVEL P. CENIZA
ROJO ASIATICO	0225160300	G	MONOCAPA	417	762	CUERO BECERRO NEGRO
					723	TELA RAVEL P. CENIZA
GRIS ALBATROS	0225160000	G	METALIZADO	418	762	CUERO BECERRO NEGRO
					723	TELA RAVEL P. CENIZA

1	2	1	2	1	2	1	2	1	2
0010545600	87-52	0706329400	12-01	7700588916	19-10	7700656300	21-50	7700686524	81-01
0220166300	76-01	0706329400	12-011	7700589081	10-40	7700656300	21-501	7700687383	33-01
0224827100	17-04	0824376400	38-01	7700591693	17-301	7700658595	21-40	7700689713	38-20
0224956900	100-00	0854329100	29-01	7700610576	21-50	7700658595	21-401	7700690984	10-60
0225095200	100-00	0854530700	81-50	7700615808	85-18	7700658595	21-402	7700691527	58-01
0225155400	100-00	0939542	10-40	7700616373	11-30	7700662816	31-40	7700692252	38-20
0225155500	100-00	0949484	10-50	7700616373	11-301	7700663431	13-01	7700692315	11-40
0225155600	100-00	0990003600	81-50	7700616373	13-351	7700665957	14-61	7700695364	21-402
0225156600	100-01	1017328	16-70	7700622284	12-01	7700665957	14-611	7700695642	21-50
0225160000	100-001	1089020200	37-60	7700627368	64-011	7700666351	13-32	7700695642	21-501
0225160000	100-01	1089020302	38-01	7700629055	19-301	7700666351	14-61	7700695993	62-35
0225160000	100-02	2210356	59-50	7700629229	10-50	7700667703	21-40	7700695993	62-36
0225160300	100-00	5003001123	11-011	7700629230	10-50	7700667703	21-401	7700695994	62-35
0225160300	100-001	5003032140	36-30	7700629541	21-201	7700667703	21-402	7700695994	62-36
0225160300	100-01	5003032165	36-30	7700630267	35-05	7700668275	35-05	7700699009	34-10
0225160300	100-02	5003101239	31-01	7700633193	21-201	7700668283	11-30	7700702427	65-01
0225160400	100-001	6000022091	36-01	7700634996	11-30	7700670967	10-60	7700703348	53-01
0225160400	100-01	6001007516	19-30	7700634996	11-301	7700670967	10-601	7700704173	21-50
0225168800	100-00	6001007516	19-301	7700634996	13-351	7700671408	11-40	7700704479	46-10
0225169300	100-00	7401317957	13-351	7700634996	48-051	7700671408	11-401	7700704480	46-10
0225169300	100-01	7700016285	55-411	7700634996	48-06	7700671408	11-402	7700704696	12-011
0225169400	100-00	7700088842	12-14	7700637724	17-301	7700673183	21-50	7700706876	17-401
0225179900	100-01	7700267481	12-151	7700637916	11-40	7700673183	21-501	7700706876	17-402
0225184100	100-011	7700267544	12-151	7700639125	37-70	7700673971	59-50	7700707307	21-40
0225184100	100-02	7700268948	11-40	7700639743	59-30	7700674564	76-01	7700707307	21-401
0225184200	100-011	7700268948	11-401	7700646863	86-31	7700675669	90-01	7700707307	21-501
0225184300	100-011	7700268948	11-402	7700647358	10-60	7700676253	83-10	7700708152	21-40
0225191100	54-01	7700518589	19-20	7700647358	10-601	7700676262	13-031	7700708152	21-401
0225191100	54-011	7700525922	10-60	7700649042	13-32	7700676262	13-032	7700708152	21-402
0225196100	100-021	7700525922	10-601	7700649095	17-30	7700678049	13-32	7700708304	10-60
0225196500	100-02	7700533137	38-01	7700649940	78-01	7700678712	13-32	7700708304	10-601
0225197000	100-02	7700535328	12-151	7700649940	78-02	7700679022	21-60	7700708605	19-541
0225197100	100-021	7700539049	38-01	7700650095	11-40	7700679059	21-40	7700710310	11-40
0225197200	100-02	7700540937	13-32	7700650095	11-401	7700679059	21-401	7700710507	31-40
0225197300	100-021	7700540937	14-61	7700650095	11-402	7700679059	21-402	7700710511	33-40
0225197800	100-02	7700549694	36-30	7700650181	86-01	7700679331	21-501	7700711058	58-40
0225198100	100-021	7700577584	21-40	7700650181	86-15	7700679331	21-60	7700711709	71-08
0225198200	100-02	7700577584	21-401	7700652153	86-20	7700679618	37-01	7700711709	74-01
0225198300	100-02	7700577584	21-402	7700653759	11-40	7700679643	12-01	7700711847	12-011
0401875800	21-201	7700580192	19-10	7700655189	10-65	7700679643	12-011	7700712901	50-27
0428724300	21-30	7700581673	37-50	7700655434	10-60	7700680341	12-151	7700712901	52-201
0556112500	21-40	7700587893	11-40	7700655434	10-601	7700680354	11-30	7700712901	52-211
0556112500	21-401	7700587893	11-401	7700655787	10-70	7700680444	21-50	7700713012	10-65
0556112500	21-402	7700587893	11-402	7700656151	10-221	7700680444	21-501	7700713992	11-40
0606715000	10-40	7700588717	11-40	7700656151	10-40	7700680837	37-01	7700713992	11-401
0607110900	38-01	7700588717	11-401	7700656205	21-40	7700681260	34-10	7700713992	11-402
0607650500	21-60	7700588717	11-402	7700656205	21-401	7700681845	21-402	7700715149	31-40
0705328400	37-60	7700588718	11-40	7700656205	21-402	7700683146	19-01	7700715482	36-35
0706329400	11-20	7700588718	11-401	7700656299	21-50	7700683559	21-201	7700715602	38-20
0706329400	11-201	7700588718	11-402	7700656299	21-501	7700685833	21-402	7700717284	11-40

7700717294	38-20	7700727701	12-553	7700734403	11-402	7700746096	21-201	7700762000	66-01
7700717540	21-201	7700727701	12-554	7700734780	14-535	7700746160	13-351	7700762000	66-03
7700717999	17-511	7700727796	12-553	7700734965	12-011	7700747945	14-611	7700762003	66-01
7700718836	11-40	7700728087	87-40	7700735508	14-611	7700749104	16-03	7700762004	66-01
7700718836	11-401	7700728983	11-40	7700735508	17-401	7700749339	21-30	7700762007	65-01
7700718836	11-402	7700728983	11-401	7700735508	17-402	7700752855	72-01	7700762007	65-05
7700719273	10-65	7700728983	11-402	7700735509	11-40	7700753072	37-20	7700762039	34-30
7700719274	10-40	7700729139	12-011	7700735509	11-401	7700754338	33-40	7700762272	33-60
7700719523	21-60	7700729156	11-011	7700735552	14-535	7700754338	33-411	7700762273	33-60
7700719559	21-60	7700729245	62-23	7700735564	17-141	7700754515	31-01	7700762798	29-01
7700720878	10-40	7700729245	62-24	7700735749	12-40	7700754850	16-03	7700762844	33-01
7700720977	38-20	7700729330	62-23	7700735836	19-40	7700754850	16-05	7700762875	64-01
7700721374	21-40	7700729729	38-20	7700735836	19-401	7700754933	37-30	7700762875	64-011
7700721374	21-401	7700729903	12-553	7700735847	11-01	7700755156	76-03	7700763104	66-01
7700721374	21-402	7700729903	12-554	7700735860	21-60	7700756460	17-401	7700763104	66-03
7700721375	21-40	7700729914	12-553	7700735913	13-351	7700756460	17-402	7700763109	46-10
7700721375	21-401	7700729914	12-554	7700736150	17-20	7700756964	36-37	7700763191	37-20
7700721375	21-402	7700729967	10-50	7700736366	13-351	7700756997	87-40	7700763215	50-40
7700721483	21-60	7700730022	11-011	7700736886	12-151	7700757111	36-30	7700763216	50-40
7700721901	38-20	7700730064	11-01	7700737092	21-40	7700757131	32-01	7700763224	66-01
7700721903	38-20	7700730064	11-011	7700737092	21-401	7700757267	50-50	7700763224	66-03
7700721905	38-20	7700730116	17-011	7700737092	21-402	7700757686	32-01	7700763237	58-40
7700722068	17-401	7700730215	36-32	7700737124	11-20	7700757691	32-01	7700763238	58-40
7700722068	17-402	7700730352	13-351	7700737124	11-201	7700757721	37-20	7700763315	31-01
7700722442	50-01	7700730561	35-05	7700737125	12-151	7700759574	50-60	7700763384	19-30
7700722443	50-01	7700730610	36-32	7700737141	13-031	7700759574	50-70	7700763384	19-301
7700722459	12-40	7700730668	62-23	7700737682	19-50	7700759574	50-72	7700763385	19-30
7700722946	16-03	7700730690	36-32	7700737682	19-501	7700760157	81-50	7700763428	71-08
7700723640	11-01	7700730830	11-40	7700738023	38-20	7700760170	76-04	7700763428	72-15
7700723640	11-011	7700730830	11-401	7700738229	14-535	7700760337	37-60	7700763428	72-151
7700723794	21-60	7700730830	11-402	7700739358	12-553	7700760479	36-10	7700763428	74-01
7700723818	16-03	7700730930	35-05	7700739358	12-554	7700760487	31-01	7700763490	64-01
7700723917	21-60	7700731057	13-351	7700739663	29-02	7700760559	58-40	7700763492	64-01
7700723918	21-60	7700731258	13-351	7700739793	17-141	7700760905	75-10	7700763492	64-011
7700724004	21-60	7700731309	12-40	7700740195	21-60	7700761132	61-20	7700763494	64-02
7700724211	10-70	7700731631	13-201	7700740205	12-151	7700761461	52-01	7700763539	31-01
7700725424	37-70	7700731871	11-301	7700740467	38-20	7700761466	52-01	7700763560	19-30
7700725747	21-40	7700731871	11-40	7700740467	11-301	7700761708	36-30	7700763560	19-301
7700725747	21-401	7700731871	11-401	7700741840	17-30	7700761713	36-30	7700763644	19-01
7700725747	21-402	7700731871	11-402	7700742038	17-511	7700761942	33-01	7700763682	31-40
7700725630	21-501	7700732043	21-60	7700742386	13-031	7700761943	33-01	7700763683	31-40
7700725630	21-60	7700732219	21-40	7700743231	21-30	7700761983	55-25	7700763704	57-02
7700725631	21-60	7700732219	21-401	7700743524	33-60	7700761991	66-01	7700764011	72-15
7700725686	38-20	7700732219	21-402	7700743525	33-60	7700761991	66-03	7700764011	72-151
7700727190	11-011	7700733023	38-20	7700743798	37-80	7700761992	66-01	7700764192	33-411
7700727193	11-301	7700733139	17-301	7700745215	11-401	7700761992	66-03	7700764193	31-40
7700727246	12-40	7700733371	12-40	7700745215	11-402	7700761994	66-01	7700764195	31-01
7700727251	11-301	7700733858	13-351	7700745932	10-221	7700761994	66-03	7700764262	71-01
7700727253	11-011	7700733912	13-351	7700745933	10-221	7700761995	66-01	7700764262	71-03
7700727684	10-78	7700734170	17-301	7700745934	10-221	7700761997	66-01	7700764273	72-15

1	2	1	2	1	2	1	2	1	2
7700764273	72-151	7700765317	37-01	7700766653	17-402	7700767943	37-01	7700769446	75-01
7700764274	72-15	7700765318	37-01	7700766654	17-401	7700767948	71-13	7700769453	75-101
7700764274	72-151	7700765394	37-01	7700766654	17-402	7700768038	19-30	7700769454	75-10
7700764277	72-15	7700765546	74-01	7700766661	61-20	7700768038	19-301	7700769454	75-101
7700764277	72-151	7700765551	71-10	7700766669	41-30	7700768040	57-02	7700769455	75-10
7700764278	72-15	7700765551	71-13	7700766669	41-301	7700768051	71-15	7700769456	75-10
7700764278	72-151	7700765552	71-15	7700766684	72-15	7700768054	64-01	7700769557	56-22
7700764283	72-15	7700765553	71-10	7700766684	72-151	7700768057	17-511	7700769611	64-01
7700764284	72-15	7700765553	71-13	7700766728	57-02	7700768062	37-30	7700769611	64-011
7700764288	57-02	7700765553	71-15	7700766793	58-40	7700768122	36-10	7700769719	19-80
7700764289	57-02	7700765576	71-01	7700766826	64-02	7700768141	56-22	7700769720	19-80
7700764366	55-25	7700765576	71-03	7700766826	64-021	7700768253	36-35	7700769840	38-01
7700764367	55-25	7700765577	71-01	7700766927	36-35	7700768263	71-05	7700769842	38-01
7700764385	71-01	7700765577	71-03	7700767134	61-01	7700768285	64-01	7700769902	76-01
7700764385	71-03	7700765608	42-01	7700767243	71-13	7700768332	87-40	7700769903	76-01
7700764451	71-01	7700765658	36-30	7700767437	55-411	7700768492	71-15	7700769904	76-01
7700764452	71-01	7700765682	71-01	7700767479	87-30	7700768498	58-40	7700769905	76-01
7700764523	36-35	7700765683	71-01	7700767519	19-10	7700768504	58-40	7700769907	76-01
7700764641	60-10	7700765685	68-01	7700767520	55-25	7700768505	58-40	7700769912	78-01
7700764643	60-10	7700765686	68-01	7700767524	36-30	7700768651	37-30	7700769913	78-01
7700764713	64-01	7700765710	84-01	7700767533	65-01	7700768695	48-06	7700769914	76-01
7700764713	64-011	7700765711	84-01	7700767533	65-05	7700768710	38-01	7700770021	66-03
7700764720	84-01	7700765725	36-40	7700767605	66-03	7700768741	64-011	7700770025	66-03
7700764729	84-01	7700765886	33-01	7700767606	66-03	7700768811	37-80	7700770029	66-03
7700764737	58-01	7700766093	84-10	7700767632	50-30	7700768813	37-80	7700770070	76-01
7700764750	80-01	7700766122	57-30	7700767633	50-30	7700768815	37-80	7700770347	55-22
7700765000	71-01	7700766126	19-80	7700767635	50-30	7700768825	50-27	7700770347	55-221
7700765001	71-01	7700766155	55-25	7700767636	50-30	7700768855	71-08	7700770369	56-40
7700765051	72-15	7700766156	55-25	7700767675	53-01	7700768857	71-08	7700770968	36-30
7700765052	72-15	7700766214	54-011	7700767684	31-01	7700768891	37-80	7700770982	19-01
7700765108	19-20	7700766247	19-80	7700767686	31-01	7700768901	66-01	7700771094	32-01
7700765138	71-01	7700766248	19-80	7700767692	87-30	7700768901	66-03	7700771166	52-201
7700765138	71-03	7700766249	19-80	7700767766	50-40	7700768903	50-40	7700771167	52-201
7700765139	71-01	7700766250	19-80	7700767767	50-40	7700768903	50-50	7700771174	66-01
7700765139	71-03	7700766268	84-01	7700767768	50-50	7700768904	50-40	7700771174	66-03
7700765175	57-02	7700766271	68-01	7700767769	50-50	7700768904	50-50	7700771238	36-35
7700765251	71-10	7700766348	71-10	7700767776	48-06	7700768941	66-01	7700771274	36-30
7700765274	50-50	7700766348	71-15	7700767807	59-30	7700768953	87-40	7700771288	71-08
7700765275	50-50	7700766367	84-20	7700767814	50-60	7700769133	19-30	7700771291	71-08
7700765276	50-40	7700766397	38-01	7700767815	50-60	7700769133	19-301	7700771309	50-30
7700765277	50-40	7700766407	84-01	7700767816	50-72	7700769160	71-03	7700771371	52-201
7700765278	50-40	7700766409	52-01	7700767817	50-72	7700769161	71-03	7700771379	37-80
7700765279	50-40	7700766425	85-18	7700767818	50-70	7700769191	62-35	7700771519	64-01
7700765307	71-10	7700766446	87-30	7700767819	50-70	7700769212	78-01	7700771519	64-011
7700765307	71-13	7700766447	87-30	7700767823	52-01	7700769212	78-02	7700771568	32-10
7700765308	72-15	7700766527	85-18	7700767836	50-27	7700769246	71-15	7700771569	32-10
7700765308	72-151	7700766569	68-01	7700767837	50-27	7700769380	37-80	7700771630	37-01
7700765309	72-15	7700766652	17-401	7700767838	50-27	7700769382	37-80	7700771672	13-031
7700765309	72-151	7700766652	17-402	7700767925	66-01	7700769382	37-81	7700771672	13-032
7700765311	36-10	7700766653	17-401	7700767925	66-03	7700769445	75-01	7700771672	46-10

1	2	1	2	1	2	1	2	1	2
7700771690	74-05	7700773235	81-12	7700774414	78-05	7700776525	76-03	7700778851	76-04
7700771771	43-01	7700773236	81-12	7700774415	78-05	7700776526	76-03	7700778866	77-01
7700771771	43-011	7700773284	64-01	7700774418	78-05	7700776531	76-03	7700779305	19-301
7700771792	36-40	7700773564	78-03	7700774417	78-05	7700776531	76-04	7700779308	37-01
7700771821	11-01	7700773758	50-70	7700774418	78-05	7700776532	76-03	7700779459	13-032
7700771821	11-011	7700773758	50-72	7700774419	76-06	7700776532	76-04	7700780081	19-01
7700771825	10-70	7700773792	71-08	7700774420	76-06	7700776627	46-10	7700780263	37-80
7700771970	55-22	7700773848	59-80	7700774422	76-06	7700776760	29-01	7700780279	37-80
7700771970	55-221	7700773855	87-52	7700774423	76-06	7700776796	14-61	7700780314	74-05
7700772016	64-01	7700773856	87-52	7700774424	76-06	7700776796	14-611	7700780338	74-01
7700772017	64-01	7700773906	72-15	7700774425	76-06	7700776876	61-20	7700780339	74-01
7700772075	83-10	7700773906	72-151	7700774525	36-35	7700776909	19-541	7700780387	74-01
7700772186	55-22	7700773909	76-04	7700774531	36-35	7700777048	76-03	7700780389	64-02
7700772186	55-221	7700773916	37-94	7700774567	56-02	7700777065	78-05	7700780488	66-01
7700772187	55-22	7700773917	37-94	7700774683	76-03	7700777066	78-05	7700780488	66-03
7700772187	55-221	7700773919	76-03	7700774721	17-401	7700777067	78-05	7700780515	87-40
7700772190	55-20	7700773919	76-04	7700774721	17-402	7700777068	78-05	7700780722	52-201
7700772191	55-20	7700773920	76-03	7700774848	64-011	7700777069	78-05	7700780778	64-01
7700772350	87-40	7700773987	76-01	7700774858	71-01	7700777070	78-05	7700780778	64-011
7700772368	68-01	7700774000	46-10	7700774858	71-03	7700777276	31-01	7700780808	57-30
7700772376	68-01	7700774015	76-03	7700774874	19-541	7700777295	31-01	7700780859	37-94
7700772392	66-01	7700774015	76-04	7700774885	37-80	7700777436	10-40	7700780921	33-411
7700772425	36-40	7700774016	76-03	7700774893	37-80	7700777437	46-10	7700781316	31-01
7700772438	19-30	7700774016	76-04	7700774936	64-01	7700777440	64-02	7700781413	50-01
7700772438	19-301	7700774019	76-03	7700775035	48-051	7700777440	64-021	7700781425	65-01
7700772596	81-40	7700774019	76-04	7700775035	48-06	7700777497	33-40	7700781425	65-05
7700772601	75-10	7700774020	76-03	7700775078	76-06	7700777517	65-01	7700781426	65-01
7700772657	71-08	7700774020	76-04	7700775106	64-01	7700777517	65-05	7700781426	65-05
7700772658	71-08	7700774021	76-03	7700775106	64-011	7700777518	65-01	7700781428	65-01
7700772695	57-30	7700774021	76-04	7700775416	55-22	7700777518	65-05	7700781431	65-05
7700772741	60-10	7700774025	76-04	7700775416	55-221	7700777520	38-01	7700781432	65-01
7700772743	60-10	7700774026	32-10	7700775438	19-541	7700777613	55-22	7700781702	52-201
7700772748	86-01	7700774027	32-10	7700775465	48-051	7700777613	55-221	7700781875	50-70
7700772765	72-15	7700774030	36-10	7700775466	48-051	7700777614	55-22	7700781875	50-72
7700772766	72-15	7700774040	76-03	7700775609	19-541	7700777614	55-221	7700781876	50-70
7700772766	72-151	7700774041	41-301	7700775641	76-01	7700777624	78-03	7700781876	50-72
7700772767	72-15	7700774127	31-40	7700775647	57-30	7700777624	78-04	7700781877	50-60
7700772767	72-151	7700774128	31-40	7700775921	71-05	7700777625	78-03	7700781878	50-60
7700772828	36-30	7700774237	38-01	7700776176	80-30	7700777625	78-04	7700781879	50-70
7700772857	37-01	7700774332	78-04	7700776177	80-30	7700777748	58-30	7700781879	50-72
7700772876	36-10	7700774333	78-03	7700776178	80-30	7700777886	78-03	7700781880	50-70
7700772903	72-15	7700774334	78-03	7700776179	80-30	7700777886	78-04	7700781880	50-72
7700772903	72-151	7700774335	76-03	7700776182	32-01	77007778173	76-06	7700782087	37-30
7700772908	59-80	7700774335	76-04	7700776280	71-01	7700778332	37-81	7700782140	19-30
7700772926	31-01	7700774336	76-03	7700776280	71-03	7700778334	37-81	7700782215	46-10
7700772937	86-15	7700774336	76-04	7700776356	76-01	7700778394	58-01	7700782217	46-10
7700772979	58-01	7700774386	76-04	7700776378	76-06	7700778443	37-81	7700782504	37-70
7700773009	19-301	7700774389	76-03	7700776393	31-01	7700778699	58-01	7700782515	78-02
7700773126	66-01	7700774400	76-06	7700776422	76-04	7700778781	36-20	7700782587	66-01
7700773126	66-05	7700774413	78-05	7700776500	46-10	7700778851	76-03	7700782587	66-03

1	2	1	2	1	2	1	2	1	2
7700782704	37-94	7700786935	10-50	7700790924	55-102	7700795485	64-011	7700802402	65-05
7700782705	37-94	7700787021	31-01	7700790925	55-102	7700795497	19-541	7700802654	55-011
7700782706	37-94	7700787239	83-10	7700790984	83-10	7700795730	52-211	7700803941	53-01
7700782757	36-35	7700787307	37-94	7700791103	55-103	7700796004	76-06	7700804074	37-60
7700782775	71-08	7700787784	84-20	7700791104	55-103	7700796025	55-411	7700804075	37-60
7700782775	74-01	7700787915	84-30	7700791105	56-351	7700796068	55-411	7700804076	37-40
7700783013	19-20	7700787977	55-22	7700791106	56-351	7700796179	57-02	7700804222	48-06
7700783144	41-10	7700787977	55-221	7700791348	35-05	7700796310	55-411	7700804334	57-02
7700783145	41-10	7700787979	55-20	7700791350	35-05	7700796462	55-411	7700804335	57-02
7700783222	17-401	7700788036	36-35	7700791750	57-02	7700796495	76-04	7700804816	66-01
7700783222	17-402	7700788337	84-20	7700792082	71-05	7700796496	76-04	7700804816	66-03
7700783245	75-10	7700788440	79-01	7700792313	50-01	7700796639	83-10	7700804818	66-01
7700783246	75-10	7700788440	79-02	7700792425	37-94	7700796914	16-03	7700804818	66-03
7700783394	37-30	7700788452	83-05	7700792479	19-10	7700796914	16-05	7700804819	66-01
7700783430	37-30	7700788452	83-06	7700792603	75-10	7700797012	76-03	7700804821	66-01
7700783499	71-05	7700788577	69-01	7700792603	75-101	7700797013	76-03	7700804824	66-03
7700784233	50-01	7700788663	38-20	7700792874	81-10	7700797013	76-04	7700804949	57-02
7700784304	46-10	7700788664	38-20	7700792875	81-10	7700797032	83-01	7700805031	19-10
7700784431	56-02	7700788764	52-211	7700792895	81-10	7700797032	83-02	7700805490	50-40
7700784643	64-011	7700788862	71-08	7700792904	81-10	7700797102	50-72	7700805480	50-50
7700784717	65-01	7700788950	41-30	7700793002	71-05	7700797219	58-30	7700805540	58-30
7700784718	65-01	7700788950	64-01	7700793188	84-20	7700797220	58-30	7700805742	55-103
7700784917	46-10	7700789207	55-221	7700793246	48-151	7700797381	57-02	7700805743	55-103
7700784918	46-10	7700789208	55-221	7700793368	55-103	7700797424	50-40	7700805898	90-01
7700784964	37-94	7700789213	55-221	7700793369	55-103	7700797424	50-50	7700806968	55-22
7700785075	37-94	7700789214	55-221	7700793371	55-102	7700797425	50-40	7700806968	55-221
7700785204	52-211	7700789225	55-221	7700793372	55-28	7700797425	50-50	7700806969	55-22
7700785220	76-03	7700789226	55-221	7700793412	65-01	7700797519	84-20	7700806969	55-221
7700785221	76-03	7700789237	55-221	7700793876	56-02	7700797628	78-04	7700807090	37-94
7700785222	76-03	7700789238	55-221	7700793996	33-01	7700797666	32-01	7700807091	37-94
7700785223	78-03	7700789300	58-30	7700794559	84-20	7700797979	34-341	7700807183	19-541
7700785231	37-94	7700789417	57-02	7700794642	56-351	7700797980	34-341	7700807307	84-10
7700785318	64-01	7700789562	55-011	7700794643	56-351	7700798264	87-52	7700807537	84-20
7700785587	52-201	7700789846	38-01	7700794670	84-20	7700798741	64-01	7700807538	84-20
7700785600	19-30	7700789894	55-011	7700794671	84-20	7700798996	64-01	7700807703	52-211
7700785600	19-301	7700789896	55-011	7700794672	84-20	7700798996	64-011	7700807927	13-031
7700785603	19-30	7700789897	55-011	7700794673	84-20	7700799581	55-25	7700807927	13-032
7700785603	19-301	7700790117	55-011	7700794674	84-20	7700799582	55-25	7700808647	16-479
7700785658	48-051	7700790148	65-05	7700794675	84-20	7700800112	38-01	7700810926	87-40
7700785790	37-01	7700790149	65-05	7700794686	84-20	7700800371	79-01	7700810967	84-01
7700786106	57-02	7700790264	36-40	7700794727	55-22	7700800371	79-02	7700810997	19-10
7700786166	37-70	7700790319	37-81	7700794727	55-221	7700800510	55-011	7700811152	81-40
7700786289	64-011	7700790325	57-02	7700794982	52-211	7700801379	58-40	7700812865	83-05
7700786460	11-01	7700790326	57-02	7700795052	57-02	7700801383	58-40	7700812865	83-06
7700786460	11-011	7700790335	55-103	7700795309	55-20	7700801465	58-30	7700813640	33-411
7700786688	46-10	7700790474	72-15	7700795309	55-22	7700801742	34-01	7700813642	33-411
7700786689	46-10	7700790474	72-151	7700795309	55-221	7700802094	52-211	7700814312	37-81
7700786740	37-81	7700790475	72-15	7700795310	55-20	7700802364	36-32	7700816146	66-03
7700786872	19-60	7700790475	72-151	7700795310	55-22	7700802381	32-01	7700816409	52-211
7700786872	19-601	7700790734	55-23	7700795310	55-221	7700802382	32-01	7700816919	36-35

1	2	1	2	1	2	1	2	1	2
7700817027	56-02	7700855358	13-031	7701030059	50-27	7701033415	34-30	7701035150	83-01
7700817696	55-20	7700856767	13-031	7701030059	52-201	7701033416	34-30	7701035151	83-01
7700817816	84-20	7700856767	13-032	7701030059	52-211	7701033430	85-18	7701035152	83-01
7700821175	66-03	7700858699	21-40	7701030061	50-10	7701033495	48-151	7701035153	83-01
7700824055	50-01	7700858699	21-401	7701030062	50-10	7701033509	56-21	7701035155	83-01
7700824056	50-01	7700859167	53-01	7701030258	16-05	7701033679	81-40	7701035254	83-05
7700824486	80-30	7700860127	12-553	7701030809	16-05	7701033730	83-02	7701035255	83-05
7700825472	81-40	7700861034	11-301	7701030810	16-05	7701033753	83-06	7701035259	83-05
7700825976	55-411	7700862127	36-32	7701030811	16-05	7701033789	52-201	7701035263	83-05
7700826996	56-02	7700862130	36-32	7701030813	16-05	7701034074	16-05	7701035268	83-05
7700827694	55-20	7700864382	17-30	7701030815	16-05	7701034097	55-22	7701035269	83-05
7700827694	55-22	7700864382	17-511	7701030817	16-05	7701034097	55-221	7701035372	52-211
7700827695	55-20	7700866055	17-141	7701030941	83-01	7701034117	86-15	7701035380	29-02
7700827695	55-22	7700900429	84-30	7701030941	83-02	7701034132	80-20	7701035828	48-101
7700827696	55-22	7700900451	55-011	7701030941	83-05	7701034133	80-20	7701035829	48-101
7700827697	55-20	7700900452	55-011	7701030941	83-06	7701034136	80-20	7701035831	48-101
7700827697	55-22	7700900453	55-103	7701031089	16-05	7701034137	80-20	7701035833	48-151
7700827700	55-20	7700900454	55-102	7701031090	52-201	7701034178	16-05	7701035834	48-151
7700827701	55-20	7700900455	55-28	7701031135	17-141	7701034276	55-411	7701035835	48-151
7700827702	55-22	7700900489	55-23	7701031959	87-52	7701034277	55-411	7701035836	48-151
7700827703	55-22	7700900526	55-011	7701032008	32-30	7701034278	55-411	7701035838	48-151
7700827704	55-20	7700900540	56-21	7701032022	81-15	7701034281	81-15	7701035839	48-151
7700827705	55-20	7700900541	56-21	7701032244	53-01	7701034282	81-15	7701036308	50-20
7700827706	55-22	7700900574	53-01	7701032297	62-30	7701034283	81-15	7701039564	50-10
7700827707	55-22	7701000955	59-50	7701032302	61-20	7701034320	30-41	7701039565	50-20
7700827978	64-02	7701000957	59-30	7701032318	34-40	7701034321	80-41	7701200820	13-01
7700827978	64-021	7701000957	59-50	7701032319	34-40	7701034355	61-20	7701202100	21-60
7700830388	56-02	7701001859	12-24	7701032412	53-01	7701034393	50-10	7701202380	34-30
7700850323	21-40	7701005981	81-50	7701032837	61-20	7701034396	50-10	7701202381	34-30
7700850323	21-401	7701021647	83-01	7701032886	76-06	7701034443	83-02	7701202382	34-30
7700850323	21-402	7701021647	83-02	7701032887	76-06	7701034446	83-06	7701202385	34-30
7700850456	17-301	7701021647	83-05	7701032894	81-10	7701034447	83-02	7701202476	32-30
7700850621	10-60	7701021647	83-06	7701032897	81-10	7701034447	83-06	7701202479	32-30
7700850621	10-601	7701021927	37-40	7701032898	81-10	7701034450	83-02	7701202480	32-30
7700850623	10-65	7701023201	50-10	7701032911	52-201	7701034451	83-02	7701202530	62-30
7700851094	12-13	7701023201	50-20	7701032943	80-20	7701034452	83-06	7701202559	66-01
7700852093	17-141	7701026873	37-40	7701033009	50-10	7701034454	83-02	7701202565	37-60
7700852662	17-141	7701027865	62-30	7701033009	50-20	7701034455	83-06	7701202568	53-01
7700853000	10-65	7701028077	32-01	7701033130	81-12	7701034457	83-02	7701202575	66-01
7700853373	10-40	7701029259	50-20	7701033191	76-06	7701034458	83-06	7701202575	66-03
7700853774	10-60	7701029260	50-10	7701033227	12-553	7701034487	50-20	7701202601	62-30
7700853774	10-601	7701029260	50-20	7701033227	12-554	7701034488	50-20	7701202603	62-30
7700853897	11-011	7701029574	12-151	7701033227	13-32	7701034489	50-10	7701202636	76-06
7700853902	12-011	7701029904	84-10	7701033227	14-611	7701034573	81-15	7701202639	76-06
7700853903	12-011	7701029906	80-20	7701033246	13-32	7701034800	29-01	7701202642	76-06
7700854710	11-20	7701029940	87-52	7701033247	14-611	7701034990	52-30	7701202645	76-06
7700854710	11-201	7701029941	87-52	7701033256	14-535	7701035088	29-01	7701202645	76-06
7700854842	11-20	7701030000	16-05	7701033354	37-50	7701035111	83-01	7701202683	17-011
7700854842	11-201	7701030058	50-10	7701033412	13-201	7701035112	83-01	7701202698	66-03
7700855243	21-60	7701030059	50-10	7701033414	83-06	7701035115	83-01	7701202701	66-05
								7701202714	71-08

1	2	1	2	1	2	1	2	1	2
7701202715	83-02	7701332227	17-401	7701367308	50-10	7701464845	55-23	7702056384	10-60
7701202715	83-06	7701332227	17-402	7701400250	81-50	7701464846	55-23	7702056384	10-601
7701202732	62-23	7701348175	13-201	7701436612	21-402	7701464919	50-01	7702056723	11-01
7701202734	62-23	7701348320	10-30	7701458596	19-70	7701465119	10-70	7702056766	13-20
7701202735	62-23	7701348471	21-201	7701460142	10-30	7701465513	11-011	7702056989	11-40
7701202738	62-23	7701348472	21-40	7701460152	10-65	7701465617	55-011	7702056989	11-401
7701202745	66-01	7701348472	21-401	7701461155	10-60	7701465626	55-23	7702056989	11-402
7701202745	66-05	7701348472	21-402	7701461649	10-60	7701465892	21-201	7702057001	11-40
7701202797	74-05	7701348540	21-40	7701461649	10-601	7701465911	29-02	7702057001	11-401
7701202800	37-92	7701348543	10-30	7701462020	31-40	7701466172	29-01	7702057001	11-402
7701202801	37-92	7701348674	32-30	7701462174	21-201	7701466172	29-02	7702057172	61-01
7701202802	37-92	7701348674	34-40	7701462486	11-20	7701466351	11-01	7702057176	13-01
7701202803	37-50	7701348820	10-30	7701462486	11-201	7701466351	11-011	7702057176	18-07
7701202804	37-921	7701348821	10-30	7701462879	10-30	7701466907	33-01	7702057296	11-30
7701202805	37-92	7701348822	10-30	7701463611	21-40	7701468034	37-01	7702057331	11-30
7701202806	37-40	7701349125	11-40	7701463611	21-401	7701624286	36-30	7702057744	13-32
7701202807	37-921	7701349125	11-401	7701463611	21-402	7701624287	36-30	7702057744	10-50
7701202808	37-92	7701349125	11-402	7701463612	21-40	7701639510	48-051	7702057817	12-01
7701202809	37-921	7701349159	10-30	7701463612	21-401	7701639510	48-06	7702057817	12-011
7701202810	37-921	7701349381	10-40	7701463698	40-10	7701639511	48-051	7702057929	12-01
7701202863	74-05	7701349382	10-40	7701463743	43-01	7701639511	48-06	7702057929	12-011
7701202869	76-06	7701349628	14-611	7701463743	43-011	7701987766	88-01	7702057939	13-32
7701202934	76-06	7701349790	53-01	7701463744	43-01	7701987766	88-015	7702057939	14-61
7701202950	66-05	7701349791	53-01	7701463744	43-011	7701996073	87-30	7702057942	10-60
7701202951	66-05	7701349799	81-40	7701463744	43-011	7701996074	87-30	7702058732	21-50
7701203069	32-30	7701349811	61-20	7701463747	43-01	7701996075	87-30	7702058732	21-501
7701203073	32-30	7701349861	80-41	7701463747	43-011	7701997040	87-30	7702060826	59-50
7701203074	32-30	7701349921	29-02	7701463748	43-01	7701997040	87-30	7702071788	58-20
7701203105	74-01	7701349928	34-30	7701463748	43-011	7701998052	81-50	7702072066	81-40
7701203110	74-01	7701349942	37-60	7701463749	43-01	7701998053	81-50	7702072090	87-40
7701203123	34-341	7701365611	81-01	7701463749	43-011	7701998054	81-50	7702072110	86-31
7701203125	34-341	7701366060	81-20	7701463750	43-01	7701998056	81-50	7702072707	85-18
7701203179	12-151	7701366136	81-20	7701463750	43-011	7701998057	81-50	7702072708	86-20
7701203193	37-50	7701366150	81-40	7701463751	43-01	7701998058	81-50	7702072739	61-20
7701203202	61-20	7701366151	81-40	7701463752	43-01	7701998059	81-50	7702072906	87-40
7701203416	34-341	7701366152	81-40	7701463875	21-60	7701998060	81-50	7702072956	86-31
7701203417	34-341	7701366152	80-25	7701464020	31-40	7701998065	81-50	7702072958	86-31
7701203418	34-341	7701366156	38-01	7701464020	31-40	7702015147	21-402	7702072958	86-31
7701203418	34-341	7701366261	56-21	7701464037	31-30	7702021841	21-201	7702073139	13-20
7701203419	34-341	7701366261	56-22	7701464043	10-40	7702021841	21-201	7702073140	13-20
7701203496	83-05	7701366263	56-21	7701464057	19-70	7702023348	12-22	7702073147	13-01
7701203498	83-05	7701366263	56-21	7701464133	10-15	7702025912	81-50	7702073154	17-04
7701203633	34-341	7701366561	81-01	7701463750	43-01	7701998056	81-50	7702073158	17-04
7701203873	16-479	7701366060	81-20	7701463750	43-011	7701998057	81-50	7702073158	17-04
7701203874	16-479	7701366136	81-40	7701463751	43-01	7701998058	81-50	7702073163	17-04
7701203877	16-479	7701366150	81-40	7701463752	43-01	7701998059	81-50	7702073202	17-04
7701203878	16-479	7701366151	81-40	7701463752	43-01	7701998059	81-50	7702073281	10-22
7701203878	16-479	7701366152	80-25	7701463875	21-60	7701998060	81-50	7702073282	10-22
7701203879	16-479	7701366156	38-01	7701464020	31-40	7701998065	81-50	7702073499	10-30
7701203879	16-479	7701366156	38-01	7701464037	31-30	7701998065	81-50	7702073500	10-30
7701203953	53-01	7701366261	56-21	7701464043	10-40	7702015147	21-402	7702073500	10-30
7701204087	32-30	7701366261	56-22	7701464057	19-70	7702021841	21-201	7702073501	10-30
7701211435	54-01	7701366263	56-21	7701464057	19-70	7702021841	21-201	7702073516	10-221
		7701366263	56-21	7701464133	10-15	7702023348	12-22	7702073516	10-60
		7701366263	56-21	7701464133	10-15	7702025912	81-50	7702073516	10-60
		7701366263	56-22	7701464134	10-151	7702025912	81-50	7702073529	62-23
		7701366264	56-21	7701464134	10-151	7702027229	21-30		
		7701366264	56-22	7701464299	42-01	7702030246	13-32		
		7701366369	56-02	7701464300	42-01	7702035219	19-402		
		7701366370	56-02	7701464301	42-01	7702052043	12-23		
		7701366487	56-02	7701464301	37-01	7702052048	12-24		
		7701366647	56-02	7701464301	37-01	7702052048	12-24		
		77013666985	57-02	7701464314	45-011	7702052049	12-24		
		7701366986	72-15	7701464441	36-30	7702052052	12-23		
		7701367105	57-02	7701464497	10-221	7702052052	12-23		
		7701367284	57-02	7701464660	47-01	7702052077	12-24		
				7701464790	11-201	7702056278	14-61		
						7702056319	12-01		

1	2	1	2	1	2	1	2	1	2
7702073529	62-24	7702086422	18-06	7702087182	14-61	7702088815	12-24	7702089541	10-15
7702073777	10-78	7702086433	61-01	7702087183	14-61	7702088816	12-24	7702091528	56-02
7702073887	16-70	7702086442	11-40	7702087184	14-61	7702088817	12-24	7702093149	21-401
7702073953	16-70	7702086442	11-401	7702087194	10-01	7702088818	12-24	7702093639	14-61
7702073954	16-70	7702086442	11-402	7702087197	12-13	7702088819	12-16	7702093639	18-06
7702073955	16-70	7702086586	12-41	7702087207	10-60	7702088821	12-22	7702094155	19-50
7702073957	16-70	7702086586	12-42	7702087234	12-13	7702088823	12-23	7702094155	19-501
7702073958	16-70	7702086588	12-41	7702087235	10-01	7702088824	12-23	7702094163	37-30
7702073959	16-70	7702086588	12-42	7702087236	13-21	7702088826	12-23	7702094165	37-20
7702073961	16-70	7702086589	12-41	7702087237	13-21	7702088827	12-13	7702094223	37-80
7702073962	16-70	7702086589	12-42	7702087245	62-24	7702088828	12-23	7702094223	37-81
7702073963	16-70	7702086590	12-41	7702087246	13-351	7702088829	12-23	7702094255	32-01
7702073964	16-70	7702086599	13-21	7702087247	16-03	7702088830	12-23	7702094310	19-30
7702073965	16-70	7702086620	36-32	7702087249	10-01	7702088831	12-23	7702094310	19-301
7702073966	16-70	7702086624	10-01	7702087250	10-01	7702088832	12-23	7702094320	19-30
7702073968	16-70	7702086641	18-06	7702087267	14-61	7702088833	12-23	7702094320	19-301
7702073969	16-70	7702086669	12-01	7702087268	14-61	7702088834	12-24	7702094321	19-30
7702073970	16-70	7702086692	12-41	7702087278	12-554	7702088835	12-22	7702094321	19-301
7702073972	16-70	7702086692	12-42	7702087279	13-032	7702088836	12-16	7702094322	19-30
7702073973	16-70	7702086697	13-32	7702087280	13-032	7702088837	12-13	7702094322	19-301
7702073974	16-70	7702086699	11-01	7702087281	13-032	7702088840	12-14	7702094357	19-30
7702073975	16-70	7702086714	12-01	7702087282	12-554	7702088841	12-14	7702094396	36-35
7702073976	16-70	7702086716	12-41	7702087283	12-553	7702088843	12-22	7702094399	36-35
7702073977	16-70	7702086716	12-42	7702087283	12-554	7702088844	12-31	7702094404	37-80
7702073978	16-70	7702086760	11-30	7702087286	10-011	7702088846	12-13	7702094411	46-10
7702073980	16-70	7702086760	11-301	7702087287	10-012	7702088848	12-13	7702094445	46-10
7702074026	77-12	7702086761	18-07	7702087291	12-13	7702088849	12-13	7702094459	32-01
7702074026	77-20	7702086763	13-01	7702087305	62-24	7702088852	19-30	7702094487	13-22
7702074026	77-201	7702086824	36-32	7702087332	14-611	7702088852	19-301	7702094496	19-40
7702074052	10-40	7702086825	62-23	7702087411	18-07	7702088853	12-24	7702094497	19-40
7702080928	19-30	7702086825	62-24	7702087438	11-30	7702088854	12-13	7702094497	19-402
7702080928	19-301	7702086866	10-60	7702087442	12-13	7702088855	12-24	7702094498	31-01
7702081436	59-30	7702086866	10-601	7702087444	12-42	7702088856	12-24	7702094513	19-401
7702081436	59-50	7702086967	13-20	7702087445	12-42	7702089190	12-29	7702094514	19-401
7702081737	59-50	7702086982	18-06	7702088575	21-50	7702089192	12-29	7702094532	37-01
7702082570	81-40	7702086985	18-06	7702088723	16-70	7702089193	12-16	7702094533	37-01
7702082673	86-31	7702087019	18-07	7702088726	16-70	7702089194	12-16	7702094534	37-20
7702085057	18-07	7702087034	10-01	7702088794	10-22	7702089195	12-13	7702094538	37-70
7702085057	19-30	7702087035	12-13	7702088796	10-30	7702089196	12-23	7702094544	19-50
7702085057	19-301	7702087049	13-22	7702088798	12-23	7702089197	12-23	7702094544	19-501
7702085058	18-06	7702087058	13-20	7702088799	12-24	7702089198	12-23	7702094551	19-50
7702085058	61-20	7702087059	13-20	7702088800	12-14	7702089202	10-30	7702094551	19-501
7702085207	19-30	7702087096	13-21	7702088801	12-24	7702089345	13-20	7702094552	19-50
7702085207	19-301	7702087096	13-22	7702088802	12-31	7702089348	21-40	7702094552	19-501
7702086163	13-32	7702087140	13-01	7702088803	12-31	7702089348	21-401	7702094579	42-01
7702086169	12-22	7702087144	11-30	7702088805	12-24	7702089348	21-402	7702094580	42-01
7702086194	11-30	7702087176	14-61	7702088806	12-24	7702089393	16-70	7702094586	36-35
7702086404	12-01	7702087176	14-611	7702088807	12-23	7702089399	16-70	7702094588	61-01
7702086411	10-40	7702087180	14-61	7702088809	12-23	7702089419	17-20	7702094592	19-40
7702086421	18-06	7702087181	14-61	7702088812	12-23	7702089431	21-50	7702094592	19-401

1	2	1	2	1	2	1	2	1	2
7702094599	19-20	7702095197	19-602	7702096178	21-60	7702098693	64-011	7702205227	88-015
7702094611	36-35	7702095211	37-81	7702096229	10-40	7702098694	64-011	7702205238	61-01
7702094654	36-40	7702095213	37-81	7702096229	16-03	7702098740	59-50	7702205261	62-35
7702094656	13-21	7702095215	37-81	7702096232	10-40	7702098741	59-55	7702205261	62-36
7702094708	19-01	7702095220	19-402	7702096235	83-10	7702098741	59-56	7702205265	10-50
7702094770	32-01	7702095221	19-402	7702096256	21-01	7702098827	64-011	7702205285	83-10
7702094771	32-01	7702095222	19-402	7702096264	21-201	7702098828	55-25	7702205290	86-31
7702094775	32-01	7702095223	19-402	7702096275	21-40	7702098830	64-02	7702205291	86-31
7702094776	32-01	7702095228	13-032	7702096275	21-401	7702098830	64-021	7702205295	88-01
7702094793	46-10	7702095231	19-402	7702096295	21-401	7702098831	64-02	7702205295	88-015
7702094800	19-50	7702095235	13-032	7702096295	21-402	7702098831	64-021	7702205302	37-40
7702094804	36-37	7702095245	33-01	7702096296	21-401	7702099089	45-011	7702205311	18-06
7702094852	19-60	7702095246	33-01	7702096296	21-402	7702099090	45-011	7702205326	87-40
7702094852	19-601	7702095279	19-541	7702096340	21-201	7702099349	18-06	7702205327	87-40
7702094853	19-60	7702095281	19-403	7702096344	21-011	7702099543	17-30	7702205332	17-04
7702094853	19-601	7702095282	19-403	7702096346	21-402	7702147800	76-03	7702205333	16-03
7702094861	33-01	7702095283	19-403	7702096364	20-01	7702147803	76-03	7702205333	16-75
7702094862	33-01	7702095284	19-403	7702096383	21-01	7702198187	87-52	7702205337	88-04
7702094894	19-50	7702095285	19-403	7702096390	21-01	7702198205	87-52	7702205337	88-06
7702094894	19-501	7702095289	19-403	7702096392	21-011	7702204318	75-01	7702205346	88-06
7702094934	19-40	7702095328	13-201	7702096396	36-01	7702204319	75-01	7702205346	88-065
7702094934	19-401	7702095390	35-05	7702096416	21-011	7702204322	74-01	7702205347	88-06
7702094942	90-01	7702095995	35-05	7702098062	59-30	7702204788	77-01	7702205347	88-065
7702094948	19-40	7702096001	21-402	7702098063	59-30	7702205100	19-01	7702205360	82-01
7702094948	19-402	7702096128	20-01	7702098066	59-30	7702205105	16-03	7702205361	82-01
7702094949	19-401	7702096142	21-40	7702098067	59-30	7702205105	16-70	7702205374	83-10
7702094949	19-403	7702096142	21-401	7702098069	59-30	7702205122	87-40	7702205376	83-10
7702094956	19-301	7702096142	21-402	7702098070	59-30	7702205152	87-30	7702205380	86-01
7702094972	32-10	7702096146	21-40	7702098071	59-30	7702205157	82-30	7702205383	10-50
7702094975	31-01	7702096146	21-401	7702098072	59-30	7702205157	87-40	7702205385	81-15
7702094976	31-01	7702096146	21-402	7702098073	59-30	7702205160	62-35	7702205387	88-06
7702095003	19-402	7702096147	21-40	7702098074	59-30	7702205160	62-36	7702205387	88-065
7702095004	19-60	7702096148	21-40	7702098167	59-50	7702205164	17-30	7702205390	88-045
7702095004	19-601	7702096149	21-40	7702098168	59-50	7702205165	62-35	7702205390	88-065
7702095004	19-602	7702096150	21-40	7702098170	59-50	7702205166	62-35	7702205395	88-01
7702095005	19-60	7702096150	21-401	7702098348	50-60	7702205167	62-35	7702205395	88-015
7702095005	19-601	7702096151	21-40	7702098349	50-60	7702205168	62-35	7702205396	88-04
7702095005	19-602	7702096151	21-401	7702098363	50-50	7702205168	62-36	7702205396	88-045
7702095009	37-20	7702096152	21-50	7702098364	50-50	7702205177	86-30	7702205397	88-04
7702095015	19-541	7702096152	21-501	7702098425	48-151	7702205200	88-06	7702205397	88-045
7702095019	19-541	7702096153	21-50	7702098426	48-151	7702205200	88-065	7702205399	88-06
7702095038	37-60	7702096153	21-501	7702098529	59-50	7702205201	86-31	7702205399	88-065
7702095085	90-01	7702096154	21-50	7702098554	50-50	7702205214	87-40	7702205400	88-06
7702095088	19-402	7702096154	21-501	7702098555	50-50	7702205216	88-04	7702205400	88-065
7702095091	35-05	7702096155	21-50	7702098556	64-01	7702205216	88-045	7702205402	86-30
7702095120	32-01	7702096155	21-501	7702098660	52-201	7702205216	88-06	7702205403	86-31
7702095123	36-40	7702096164	21-40	7702098678	41-301	7702205216	88-065	7702205405	88-04
7702095124	36-40	7702096164	21-401	7702098685	48-06	7702205218	61-01	7702205405	88-045
7702095181	37-20	7702096164	21-402	7702098689	50-50	7702205219	61-01	7702205405	88-06
7702095188	19-541	7702096170	21-01	7702098690	50-50	7702205227	88-01	7702205405	88-065

1	2	1	2	1	2	1	2	1	2
7702205406	88-04	7702206104	42-10	7702206331	12-16	7702206973	54-011	7702212305	77-20
7702205406	88-045	7702206106	42-01	7702206332	12-23	7702206985	12-16	7702212309	77-12
7702205406	88-06	7702206107	42-01	7702206363	13-20	7702206986	12-24	7702212313	77-20
7702205406	88-065	7702206108	42-01	7702206364	13-20	7702206987	12-24	7702212317	78-10
7702205407	88-04	7702206109	42-01	7702206365	13-20	7702206989	12-24	7702212317	78-102
7702205407	88-045	7702206110	59-50	7702206366	13-20	7702206990	12-24	7702212321	78-102
7702205408	88-015	7702206138	59-50	7702206404	10-15	7702206991	12-13	7702212413	80-01
7702205409	88-01	7702206160	32-30	7702206407	10-15	7702206992	12-13	7702212414	80-01
7702205410	84-30	7702206161	32-30	7702206407	10-151	7702207316	64-01	7702213351	78-10
7702205411	17-04	7702206162	32-30	7702206407	11-30	7702207316	64-011	7702213355	78-10
7702205412	86-30	7702206163	32-30	7702206407	11-301	7702208398	79-01	7702213358	79-01
7702205417	88-01	7702206164	32-30	7702206545	10-60	7702208398	79-02	7702213366	79-01
7702205421	17-401	7702206165	32-30	7702206562	62-35	7702208408	79-01	7702213445	69-05
7702205422	17-402	7702206166	32-30	7702206562	62-36	7702208408	79-02	7702213453	78-102
7702205423	16-03	7702206166	34-40	7702206610	10-01	7702208812	71-05	7702213456	78-102
7702205423	16-76	7702206173	85-03	7702206613	17-04	7702208895	71-03	7702213778	59-56
7702205424	88-01	7702206174	85-03	7702206615	17-04	7702208896	71-03	7702213779	59-56
7702205424	88-015	7702206175	85-03	7702206618	17-04	7702208901	69-05	7702213800	59-56
7702205426	37-94	7702206176	85-03	7702206619	17-04	7702209010	74-01	7702213801	59-58
7702205428	83-10	7702206177	85-03	7702206633	16-75	7702210843	74-05	7702213802	59-56
7702205430	88-045	7702206178	85-03	7702206635	16-75	7702210851	71-08	7702213803	59-58
7702205434	86-30	7702206179	85-03	7702206640	16-75	7702211000	74-05	7702213804	59-56
7702205436	88-06	7702206180	85-23	7702206641	16-75	7702211062	71-08	7702213807	56-22
7702205436	88-065	7702206181	40-10	7702206644	16-75	7702211242	74-01	7702213808	56-22
7702205437	88-045	7702206181	40-101	7702206645	16-75	7702211435	54-011	7702213946	54-011
7702205438	88-065	7702206182	40-10	7702206647	16-75	7702211435	58-20	7702214333	55-011
7702205440	88-04	7702206182	40-101	7702206651	16-75	7702211436	58-20	7702215117	79-01
7702205440	88-045	7702206186	54-01	7702206654	16-75	7702211469	54-01	7702215117	79-02
7702205440	88-06	7702206216	40-011	7702206655	16-75	7702211469	54-011	7702215119	79-01
7702205440	88-065	7702206221	62-30	7702206656	16-75	7702211470	54-01	7702215318	68-01
7702205441	88-04	7702206223	61-20	7702206678	19-301	7702211470	54-011	7702215344	68-01
7702205441	88-045	7702206224	61-20	7702206702	32-10	7702211471	54-01	7702215359	69-05
7702205441	88-06	7702206225	61-20	7702206703	17-20	7702211472	54-01	7702215370	78-101
7702205442	88-045	7702206227	64-01	7702206704	17-20	7702211477	54-01	7702215371	78-25
7702205442	88-065	7702206227	64-011	7702206800	10-01	7702211478	54-01	7702215374	78-101
7702205443	83-10	7702206229	54-011	7702206801	62-35	7702211490	54-011	7702215375	78-25
7702205444	86-30	7702206230	54-011	7702206801	62-36	7702211491	54-011	7702215378	78-101
7702205452	17-05	7702206243	59-50	7702206805	40-01	7702211497	55-25	7702215378	78-25
7702205453	86-30	7702206244	59-50	7702206806	40-01	7702211501	71-03	7702215380	78-101
7702205456	86-30	7702206251	59-55	7702206811	46-01	7702211502	71-03	7702215380	78-25
7702205457	86-30	7702206252	59-55	7702206812	46-01	7702211543	71-03	7702215801	77-201
7702206010	11-01	7702206253	59-55	7702206818	40-011	7702211544	71-03	7702215802	77-12
7702206038	86-31	7702206293	16-03	7702206865	21-50	7702212160	69-01	7702215803	77-201
7702206049	33-01	7702206314	80-25	7702206866	21-50	7702212175	78-25	7702215804	77-12
7702206057	74-01	7702206318	17-10	7702206866	21-501	7702212180	78-25	7702215805	78-103
7702206082	12-29	7702206321	10-40	7702206869	12-14	7702212187	78-25	7702215806	78-10
7702206083	12-29	7702206325	12-23	7702206913	48-051	7702212192	78-25	7702215807	78-103
7702206084	11-20	7702206328	12-23	7702206927	61-20	7702212197	78-25	7702215808	78-10
7702206099	16-70	7702206329	12-23	7702206965	30-25	7702212202	78-25	7702215809	78-103
7702206100	16-70	7702206330	12-23	7702206973	54-01	7702212305	77-12	7702215810	78-10

1	2	1	2	1	2	1	2	1	2
7702215824	71-05	7702217344	17-05	7702220314	78-104	7703001140	11-40	7703001498	11-402
7702215825	71-05	7702217345	17-05	7702220316	78-104	7703001140	11-401	7703001607	11-01
7702215826	71-05	7702217346	17-05	7702220318	78-101	7703001140	11-402	7703001607	11-011
7702215829	71-05	7702217347	17-05	7702220319	78-101	7703001142	10-65	7703001608	19-30
7702216559	62-24	7702217348	17-05	7702220321	78-101	7703001142	11-30	7703001608	19-301
7702216563	62-35	7702217350	17-05	7702220322	78-101	7703001142	11-301	7703001608	21-201
7702216563	62-36	7702217392	43-01	7702220323	79-02	7703001143	37-20	7703001614	21-201
7702216564	62-35	7702217393	43-01	7702220326	78-26	7703001146	11-01	7703001634	36-32
7702216589	88-01	7702217393	43-011	7702220327	78-26	7703001158	11-011	7703001750	19-50
7702216589	88-015	7702217396	43-011	7702220330	78-26	7703001158	21-201	7703001750	19-501
7702216591	88-01	7702217413	37-01	7702220331	78-26	7703001158	46-10	7703001800	32-01
7702216591	88-015	7702217429	32-01	7702220333	78-26	7703001158	75-10	7703001820	21-201
7702216671	62-36	7702217430	32-01	7702220334	78-26	7703001160	10-40	7703001820	76-06
7702216672	62-36	7702217437	62-24	7702220338	72-01	7703001160	10-65	7703001822	21-201
7702217032	10-011	7702217454	10-15	7702220339	72-01	7703001160	12-011	7703001848	11-01
7702217035	19-301	7702217491	85-18	7702220340	72-01	7703001160	41-301	7703001865	12-553
7702217036	10-012	7702217509	40-10	7702220341	72-01	7703001162	11-01	7703001865	36-35
7702217058	85-18	7702217509	40-101	7702220342	72-01	7703001162	11-011	7703001865	46-01
7702217059	85-18	7702217521	55-102	7702220343	72-01	7703001162	16-03	7703001865	52-01
7702217085	21-50	7702217532	11-011	7702220344	72-01	7703001162	55-102	7703001904	48-051
7702217085	21-501	7702217533	10-15	7702220345	72-01	7703001162	55-103	7703001904	48-06
7702217125	32-10	7702217549	37-01	7702220346	72-01	7703001162	62-23	7703001904	50-01
7702217126	16-76	7702217550	36-32	7702220347	72-01	7703001162	62-24	7703001904	55-102
7702217128	16-76	7702218566	37-94	7702220567	12-151	7703001162	76-03	7703001904	57-02
7702217130	16-76	7702218566	87-40	7702220570	10-012	7703001162	76-04	7703001905	36-37
7702217131	16-76	7702218567	87-40	7702220613	12-40	7703001164	21-30	7703001946	12-40
7702217132	16-76	7702219030	68-01	7702221700	88-04	7703001165	21-30	7703001956	37-30
7702217133	16-76	7702219031	68-01	7702221701	88-04	7703001167	21-30	7703002008	41-10
7702217134	16-76	7702219032	68-01	7702221701	88-045	7703001167	55-011	7703002020	46-01
7702217135	16-76	7702219244	19-301	7702221703	88-06	7703001169	36-32	7703002022	48-051
7702217136	16-76	7702219417	56-02	7702238080	62-23	7703001177	19-541	7703002037	10-40
7702217137	16-76	7702219427	55-011	7702792081	71-05	7703001186	21-30	7703002058	42-01
7702217138	16-76	7702219492	56-02	7703001018	13-01	7703001188	21-30	7703004077	50-10
7702217139	16-76	7702220158	71-05	7703001118	34-40	7703001196	21-30	7703004077	50-20
7702217140	16-76	7702220160	71-08	7703001118	36-35	7703001236	17-30	7703004128	31-40
7702217142	16-76	7702220161	71-08	7703001118	50-30	7703001236	17-511	7703004128	33-411
7702217143	16-76	7702220162	71-08	7703001118	76-01	7703001238	21-201	7703004131	87-52
7702217152	62-30	7702220176	37-94	7703001118	76-03	7703001240	21-201	7703004149	84-10
7702217154	62-30	7702220178	69-01	7703001118	76-04	7703001241	21-201	7703005065	50-01
7702217191	13-201	7702220177	69-01	7703001118	76-06	7703001241	52-01	7703006104	55-103
7702217235	48-06	7702220243	77-201	7703001120	12-554	7703001244	36-32	7703006106	45-011
7702217305	17-05	7702220244	77-201	7703001122	13-351	7703001373	21-201	7703006115	57-02
7702217306	17-05	7702220245	79-02	7703001122	19-01	7703001373	31-01	7703006116	12-151
7702217307	17-05	7702220301	77-201	7703001122	42-01	7703001373	32-10	7703006123	75-10
7702217308	17-05	7702220303	78-103	7703001123	12-553	7703001423	21-201	7703006133	50-40
7702217309	17-05	7702220303	78-104	7703001123	12-554	7703001443	21-201	7703006133	50-50
7702217310	17-05	7702220305	78-103	7703001123	52-201	7703001447	36-35	7703007154	34-30
7702217311	17-05	7702220308	78-103	7703001123	52-211	7703001451	21-30	7703007158	31-40
7702217312	17-05	7702220309	79-02	7703001127	38-20	7703001498	11-40	7703008038	84-01
7702217326	40-01	7702220312	78-104	7703001138	11-301	7703001498	11-401	7703008051	74-01

1	2	1	2	1	2	1	2	1	2
7703008069	50-60	7703016485	57-02	7703033027	43-01	7703041018	17-401	7703053037	16-03
7703008069	50-70	7703016485	58-30	7703033027	43-011	7703041018	17-402	7703053037	36-32
7703008069	50-72	7703016518	55-20	7703033027	50-01	7703044052	75-10	7703053037	62-23
7703008084	55-25	7703016518	55-22	7703033027	55-22	7703044087	45-011	7703053037	62-24
7703009005	17-011	7703016518	55-221	7703033027	55-221	7703044094	46-10	7703053043	19-80
7703009059	20-01	7703017002	50-27	7703033027	55-23	7703044097	85-03	7703053043	36-32
7703009104	12-151	7703017002	52-201	7703033027	56-22	7703044102	52-01	7703053043	76-01
7703009128	33-40	7703017002	52-211	7703033027	59-80	7703044102	55-103	7703053067	17-141
7703009153	10-50	7703019087	36-35	7703033033	42-01	7703044112	42-01	7703053075	36-30
7703009155	10-50	7703019120	76-03	7703033033	48-051	7703044113	19-30	7703053127	19-50
7703009166	13-351	7703019120	76-04	7703033039	48-06	7703044113	19-301	7703053127	19-501
7703015115	55-102	7703019139	80-01	7703033039	75-10	7703044113	32-10	7703053127	19-541
7703015115	55-103	7703025004	75-10	7703033039	76-03	7703046020	55-011	7703053138	62-23
7703016064	72-15	7703027048	12-01	7703033039	76-04	7703046020	55-102	7703053138	62-24
7703016064	72-151	7703027048	12-011	7703033042	11-401	7703046020	55-103	7703053172	57-02
7703016214	72-15	7703027076	11-20	7703033042	11-402	7703046048	42-01	7703053189	10-65
7703016214	72-151	7703027076	11-201	7703034007	13-32	7703046048	55-102	7703053259	10-60
7703016264	19-50	7703027094	11-40	7703034008	55-102	7703046049	19-541	7703053259	10-601
7703016264	19-501	7703027094	11-401	7703034008	55-103	7703046069	56-351	7703053291	10-65
7703016264	19-541	7703027094	11-402	7703034008	55-28	7703046082	55-103	7703053292	11-40
7703016285	57-02	7703027113	11-30	7703034027	36-30	7703046082	55-411	7703053292	11-401
7703016287	55-20	7703027113	11-301	7703034027	38-20	7703046082	58-30	7703053292	11-402
7703016287	55-22	7703027191	10-40	7703034062	32-01	7703046091	80-25	7703053338	12-151
7703016287	55-221	7703027191	11-40	7703034068	31-40	7703046093	71-08	7703053345	11-40
7703016340	55-25	7703027191	11-401	7703034083	33-01	7703046098	57-02	7703053389	36-10
7703016340	55-411	7703027191	11-402	7703034087	19-541	7703046098	72-15	7703053445	34-01
7703016401	55-411	7703027226	10-40	7703034098	31-01	7703046098	72-151	7703053521	21-201
7703016401	58-40	7703027228	11-30	7703034106	19-80	7703046098	74-01	7703053537	38-20
7703016401	71-01	7703027228	11-301	7703034106	36-10	7703049048	57-02	7703053544	38-20
7703016401	71-03	7703032047	12-01	7703034106	36-30	7703050054	38-01	7703053544	59-50
7703016401	71-05	7703032047	12-011	7703034114	31-01	7703050114	37-01	7703053550	16-03
7703016401	71-08	7703032047	13-21	7703034114	36-30	7703050116	17-141	7703053642	17-30
7703016401	71-10	7703032047	19-50	7703034115	31-01	7703050129	37-01	7703053642	17-511
7703016401	71-13	7703032047	19-501	7703034118	33-40	7703053015	31-01	7703053649	31-01
7703016401	71-15	7703032063	11-40	7703034118	33-411	7703053029	13-32	7703053654	12-151
7703016401	72-15	7703032067	85-18	7703034121	38-01	7703053032	13-351	7703053700	11-40
7703016401	72-151	7703032101	16-03	7703034122	19-80	7703053032	50-40	7703053700	11-401
7703016401	74-01	7703032103	62-23	7703035003	38-20	7703053032	50-50	7703053700	11-402
7703016401	76-06	7703032103	62-24	7703035011	46-01	7703053032	55-102	7703055005	16-70
7703016401	87-52	7703032103	76-06	7703035011	56-351	7703053032	57-02	7703055007	12-553
7703016404	58-30	7703032131	13-351	7703035015	50-60	7703053033	17-10	7703055007	12-554
7703016405	56-351	7703032131	57-02	7703035015	50-70	7703053036	11-011	7703055007	13-351
7703016407	55-103	7703032131	58-30	7703035018	36-37	7703053036	11-301	7703055007	19-01
7703016407	60-10	7703033003	11-30	7703035018	38-20	7703053036	20-01	7703055007	38-20
7703016407	71-08	7703033003	11-301	7703035020	37-01	7703053036	36-32	7703055011	11-01
7703016407	76-01	7703033005	80-30	7703037011	85-03	7703053037	10-65	7703055011	11-011
7703016407	76-03	7703033025	17-141	7703037013	85-18	7703053037	11-01	7703055011	12-011
7703016407	76-04	7703033027	19-60	7703040028	21-40	7703053037	11-011	7703055011	13-01
7703016410	58-01	7703033027	19-601	7703040028	21-401	7703053037	12-01	7703055011	16-03
7703016416	76-06	7703033027	19-602	7703040028	21-402	7703053037	12-011	7703055011	16-70

1	2	1	2	1	2	1	2	1	2
7703055011	21-30	7703061048	55-221	7703067081	21-60	7703074073	64-021	7703076164	74-01
7703055011	21-40	7703061048	55-23	7703067082	21-60	7703074097	12-011	7703076171	55-25
7703055011	21-401	7703061048	59-80	7703067137	21-60	7703074105	14-611	7703076183	55-22
7703055011	31-01	7703061131	21-60	7703067216	38-20	7703074175	64-011	7703076183	55-221
7703055011	32-01	7703062001	11-01	7703067250	11-40	7703074255	86-01	7703076188	54-01
7703055011	62-23	7703062001	11-011	7703067250	11-401	7703074280	38-20	7703076188	54-011
7703055011	62-24	7703062013	10-40	7703067250	11-402	7703074297	64-01	7703077006	55-20
7703055013	21-30	7703062043	10-70	7703067259	21-60	7703074297	64-011	7703077006	55-22
7703055013	62-23	7703062068	11-011	7703067293	50-01	7703074316	64-02	7703077006	55-221
7703055013	62-24	7703065037	21-60	7703068002	37-01	7703074316	64-021	7703077045	72-15
7703055015	21-402	7703065074	21-201	7703070007	10-65	7703074329	64-01	7703077045	72-151
7703055021	32-10	7703065082	17-011	7703070007	11-40	7703074329	64-011	7703077068	71-05
7703055022	20-01	7703065082	37-30	7703070007	11-401	7703074335	64-02	7703077068	74-01
7703055031	10-40	7703065088	13-01	7703070007	11-402	7703074335	64-021	7703077090	71-08
7703055031	10-65	7703065106	36-35	7703070009	10-60	7703074336	64-01	7703077112	76-03
7703055031	11-01	7703065119	14-535	7703070009	10-601	7703074336	64-011	7703077112	76-04
7703055031	11-011	7703065128	21-50	7703072046	36-10	7703074338	64-011	7703077112	76-06
7703055031	19-30	7703065128	21-501	7703072046	46-10	7703074339	64-02	7703077117	68-01
7703055031	19-301	7703065164	36-10	7703072048	57-30	7703074339	64-021	7703077135	55-011
7703055035	20-01	7703065190	59-80	7703072050	50-27	7703074339	37-01	7703077183	71-01
7703055035	31-40	7703065191	59-80	7703072050	50-40	7703074424	64-011	7703077183	71-03
7703055037	12-01	7703065243	36-35	7703072050	50-50	7703075009	10-40	7703077183	72-01
7703055037	12-011	7703066071	12-24	7703072050	64-011	7703075009	12-01	7703077197	76-06
7703056083	48-051	7703066153	12-151	7703072172	55-20	7703075012	21-201	7703077210	10-40
7703056083	48-06	7703066153	52-201	7703072172	55-22	7703075025	10-40	7703077222	71-13
7703056083	50-01	7703066159	21-40	7703072172	55-221	7703075032	11-20	7703077225	56-351
7703056083	50-30	7703066159	21-401	7703072172	76-06	7703075032	11-201	7703077235	62-35
7703056083	52-01	7703066159	21-402	7703072213	41-20	7703075034	12-01	7703077235	62-36
7703056083	52-201	7703066192	21-40	7703072213	41-30	7703075038	11-20	7703077238	55-23
7703056083	52-211	7703066192	21-401	7703072213	41-301	7703075038	11-201	7703077244	71-05
7703056085	55-102	7703066192	21-402	7703072230	55-103	7703075038	12-01	7703077249	64-01
7703056085	55-103	7703066231	10-70	7703072231	66-05	7703075039	11-40	7703077249	64-011
7703056372	21-40	7703066241	37-01	7703072236	76-08	7703075039	11-401	7703077250	71-08
7703057021	37-01	7703066269	21-40	7703072239	55-411	7703075039	11-402	7703077255	71-05
7703057050	21-60	7703066269	21-401	7703072252	54-01	7703075053	11-40	7703079027	50-50
7703057061	37-01	7703066269	21-402	7703072252	54-011	7703075053	11-401	7703079071	37-20
7703058002	76-01	7703066295	37-30	7703072263	66-05	7703075053	11-402	7703079072	83-10
7703058006	21-201	7703066297	37-01	7703072276	55-20	7703075059	21-201	7703079128	61-01
7703058007	16-03	7703066372	21-401	7703072276	55-22	7703075059	21-60	7703079137	37-80
7703058008	75-10	7703066372	21-402	7703072276	55-221	7703075072	21-201	7703079146	83-10
7703058043	19-80	7703066377	21-40	7703073212	64-01	7703075076	10-40	7703079254	37-80
7703058045	36-32	7703066386	21-401	7703073212	64-011	7703075138	10-40	7703079255	37-80
7703058045	46-10	7703066386	21-402	7703073213	64-011	7703075144	11-20	7703079285	37-30
7703058047	21-40	7703067009	21-402	7703073217	64-02	7703075144	11-201	7703079285	83-10
7703058047	21-401	7703067030	21-40	7703073217	64-021	7703075206	10-40	7703079349	37-80
7703058047	21-402	7703067030	21-401	7703073222	48-051	7703076066	12-151	7703079366	87-30
7703058048	75-10	7703067030	21-60	7703073222	48-06	7703076099	61-20	7703079383	37-80
7703061007	19-20	7703067069	21-60	7703074022	71-01	7703076105	74-01	7703079384	37-80
7703061031	55-25	7703067080	10-60	7703074022	71-03	7703076126	68-01	7703079385	37-80
7703061048	55-22	7703067080	10-601	7703074022	72-01	7703076155	58-30	7703079389	52-01

1	2	1	2	1	2	1	2	1	2
7703079405	37-80	7703082025	41-301	7703097387	81-50	7704001592	37-80	7705015174	21-60
7703079406	37-80	7703083269	19-20	7703097516	81-50	7704001666	13-031	7705015212	36-10
7703079409	50-60	7703083269	61-01	7703100634	16-03	7704001666	13-032	7705015228	19-50
7703079409	50-70	7703084363	71-03	7703101034	32-01	7704001952	37-80	7705015228	19-501
7703079409	50-72	7703087106	21-201	7703101045	36-32	7704001952	37-81	7705015228	19-541
7703079411	86-01	7703087117	21-501	7703101045	62-23	7704002011	32-01	7705026013	19-30
7703079420	37-80	7703087117	21-60	7703101045	62-24	7704002215	86-01	7705026254	19-30
7703079455	90-01	7703087179	21-60	7703101055	34-10	7704002263	33-40	7705026254	19-301
7703080031	61-20	7703088015	48-051	7703101065	34-01	7704002509	13-031	7705026440	19-30
7703080032	80-01	7703088015	57-02	7703101069	10-65	7704002578	21-201	7705026443	14-61
7703080036	86-20	7703088069	43-01	7703101069	19-80	7705001094	17-141	7705026659	13-32
7703080049	55-23	7703088069	43-011	7703101069	76-06	7705001210	11-301	7705026798	12-40
7703080054	72-15	7703088070	43-01	7703101070	62-23	7705001211	11-30	7705026997	19-402
7703080054	72-151	7703088070	43-011	7703101070	62-24	7705001211	11-301	7705026997	19-403
7703080060	71-01	7703090179	21-50	7703101072	16-03	7705001310	19-541	7705028076	57-30
7703080060	71-03	7703090179	21-501	7703101072	36-32	7705001316	19-50	7705029020	43-01
7703081019	55-411	7703090215	21-60	7703101073	62-23	7705001316	19-501	7705029020	43-011
7703081019	58-30	7703090244	21-40	7703101073	62-24	7705001368	11-301	7705029021	43-01
7703081019	71-01	7703090244	21-401	7703101074	36-30	7705002056	37-30	7705029021	43-011
7703081019	71-03	7703090244	21-402	7703101075	36-32	7705002060	86-01	7705029021	12-41
7703081019	71-05	7703090245	21-40	7703101075	62-23	7705005078	13-351	7705030057	12-42
7703081019	71-08	7703090245	21-401	7703101075	62-24	7705005104	13-351	7705030059	13-32
7703081026	55-25	7703090245	21-402	7703101081	16-03	7705005109	19-50	7705030089	12-01
7703081026	58-40	7703090256	21-40	7703101091	11-40	7705005109	19-501	7705030090	12-011
7703081026	71-01	7703090256	21-401	7703101091	32-30	7705005109	19-541	7705030155	12-41
7703081026	71-03	7703090256	21-402	7703101147	31-01	7705005119	36-35	7705030155	12-42
7703081026	71-10	7703090261	21-401	7703101160	48-051	7705005123	19-541	7705030246	14-535
7703081026	71-13	7703090261	21-402	7703101160	76-04	7705005132	62-35	7705035153	37-01
7703081026	71-15	7703090277	21-50	7703101200	31-01	7705005132	62-36	7705035169	55-23
7703081026	72-15	7703090277	21-501	7703101216	36-32	7705005195	13-031	7705075127	21-60
7703081026	72-151	7703090293	36-30	7703101220	80-20	7705005195	13-032	7705098008	59-30
7703081054	37-94	7703090295	21-40	7703101221	37-20	7705010000	11-20	7705098042	59-30
7703081054	68-01	7703090295	21-401	7703101230	36-30	7705010000	11-201	7705098059	80-20
7703081054	69-01	7703090297	21-40	7703101251	33-01	7705010008	21-401	7705098084	36-32
7703081054	69-05	7703090297	21-401	7703101252	34-01	7705010008	21-402	7705099009	66-01
7703081064	36-30	7703090297	21-402	7703101253	33-01	7705010061	10-40	7705099009	66-03
7703081081	55-25	7703090297	21-60	7703217155	62-30	7705010084	50-01	7708724428	21-40
7703081086	55-25	7703090367	21-40	7704000008	86-01	7705010085	21-201	7708724429	21-40
7703081093	58-30	7703090400	21-40	7704000043	86-01	7705010087	16-03	7708724429	21-401
7703081096	69-01	7703090400	21-401	7704000043	86-15	7705010101	21-201	7705753483	41-20
7703081096	69-05	7703090400	21-402	7704000051	86-15	7705010188	21-30	7705753485	41-20
7703081097	64-01	7703097178	81-50	7704000276	11-01	7705015003	11-40	7705753711	41-30
7703081097	64-011	7703097179	81-50	7704000302	64-021	7705015003	11-401	7705753728	41-30
7703081097	69-01	7703097181	81-50	7704000454	21-30	7705015003	11-402	7705753730	41-30
7703081097	69-05	7703097182	81-50	7704000715	14-61	7705015117	21-60	7705753998	41-30
7703081101	36-30	7703097183	81-50	7704000715	14-611	7705015125	11-40	7705753998	41-301
7703081104	72-15	7703097184	61-20	7704000797	11-01	7705015147	21-40	7705754058	41-10
7703081151	56-02	7703097184	81-50	7704001019	86-15	7705015147	21-401	7705754078	41-10
7703081161	55-411	7703097185	81-50	7704001363	21-60	7705015147	21-60	7705759562	43-10
7703082025	41-30	7703097186	81-50	7704001432	36-35	7705015159	38-20	7705760095	41-10

7750760097	41-10	7750774031	41-301	7751465606	44-011	7773083332	19-20	7903056014	13-21
7750760645	44-011	7750776277	42-01	7751465607	40-101	7773083931	19-20	7903056014	52-01
7750760646	44-011	7750776363	42-01	7751465608	40-101	7903032006	16-03	7903056014	52-201
7750760680	45-01	7750777569	42-01	7751465633	41-301	7903032009	16-03	7903056037	17-10
7750761161	41-20	7750783932	45-011	7751465634	41-301	7903032009	17-10	7903056039	36-35
7750761163	41-20	7750784494	41-10	7751466720	45-01	7903032009	19-01	7903056042	11-30
7750761165	41-20	7750784495	41-10	7751626732	44-01	7903032009	52-01	7903056042	37-20
7750761167	41-20	7750785342	41-10	7751626733	44-01	7903032010	56-21	7903056046	17-141
7750761437	41-20	7750785678	44-20	7751626762	41-10	7903032012	11-01	7903056046	36-32
7750761581	43-01	7750785800	41-30	7751626764	41-10	7903032012	11-011	7903056048	59-50
7750761581	43-011	7750785990	42-01	7751626932	40-10	7903032012	11-30	7903056048	59-55
7750761582	43-01	7750785991	42-01	7751626933	40-10	7903032012	11-301	7903056054	37-30
7750761582	43-011	7750793576	43-101	7751626954	42-01	7903032012	36-32	7903057002	10-40
7750761909	42-10	7750793577	43-101	7751626955	42-01	7903032018	11-40	7903057005	11-40
7750762099	42-01	7750793649	43-10	7751626961	42-10	7903032018	11-401	7903057005	11-401
7750763648	41-30	7750793650	43-10	7751626969	44-01	7903032018	11-402	7903057005	11-402
7750763648	41-301	7750805979	48-051	7751628509	43-101	7903032018	12-011	7903057005	12-151
7750763766	41-301	7750805980	48-051	7751629070	43-101	7903032018	13-01	7903057013	17-011
7750764009	44-01	7750823378	41-301	7751629081	43-101	7903032018	16-03	7903067016	29-01
7750764010	44-01	7750826889	42-01	7751629082	43-101	7903032018	36-32	7903075033	10-50
7750764733	41-10	7751454073	42-01	7751629112	40-101	7903032018	76-01	7910015788	11-40
7750765400	41-30	7751464188	44-011	7751629114	41-301	7903032072	16-70	7910019274	11-40
7750765520	43-011	7751464499	43-10	7751629117	41-301	7903053028	19-01	7910019274	11-401
7750765521	43-011	7751464499	43-101	7751629126	48-06	7903053028	38-01	7910019274	11-402
7750765810	42-10	7751464653	47-01	7751630403	41-301	7903053038	11-30	7946002384	10-601
7750765887	41-10	7751464654	47-01	7751631062	41-30	7903053043	13-01	7946006314	11-40
7750765888	41-10	7751464655	47-01	7751631063	41-30	7903053043	13-21	7946006314	11-401
7750766146	43-101	7751464656	47-01	7751631063	43-011	7903053043	21-201	7946006314	11-402
7750766323	43-011	7751464657	47-01	7751631731	43-011	7903053043	21-30	802614445	12-23
7750766324	43-011	7751464658	47-01	7751631732	43-10	7903053043	31-01	9554895580	10-40
7750766439	42-01	7751464659	47-01	7751631740	43-101	7903053043	32-01	9900097	13-32
7750766525	42-10	7751464772	41-10	7751631741	43-10	7903053043	32-10		
7750768214	41-301	7751464773	41-10	7751631741	43-101	7903053043	76-01		
7750768420	41-10	7751464891	47-01	7751631742	44-01	7903053050	16-03		
7750768474	41-301	7751464892	47-01	7751631743	44-01	7903053050	21-30		
7750768740	41-10	7751464893	47-01	7751640413	43-01	7903053050	21-30		
7750769633	41-301	7751464894	47-01	7751640414	43-01	7903053061	34-10		
7750770321	44-01	7751465082	43-011	7751647776	43-10	7903053114	32-01		
7750770322	44-01	7751465359	48-051	7751647776	43-101	7903053157	34-01		
7750770683	42-01	7751465359	48-06	7751647777	43-10	7903053157	10-65		
							11-01		
7750770684	42-01	7751465469	43-01	7751647777	43-101	7903053184	11-40		
7750771546	43-01	7751465469	43-011	7751647793	44-20	7903053184	11-401		
7750771546	43-011	7751465470	43-01	7751647794	44-20	7903053184	11-402		
7750771962	41-301	7751465470	43-011	7751654072	42-01	7903056005	16-03		
7750772927	41-10	7751465471	43-01	7753764897	41-30	7903056008	16-03		
7750772928	41-10	7751465471	43-011	7773083324	61-01	7903056008	34-40		
7750773522	43-101	7751465472	43-01	7773083325	61-01	7903056008	58-30		
7750773523	43-101	7751465472	43-011	7773083327	61-01	7903056012	11-40		
7750773524	43-101	7751465472	43-011	7773083327	19-20	7903056012	11-401		
7750773524	43-101	7751465596	44-20	7773083328	61-01	7903056012	11-402		
7750773525	43-101	7751465605	43-011	7773083331					